

PRICE \$2.00

c. 1969

HEATH COMPANY BENTON HARBOR MICHIGAN

HEATHKIT[®] ASSEMBLY MANUAL



TV POST-MARKER / SWEEP GENERATOR

MODEL IG-57A

1-595-1143-01

2-6-70

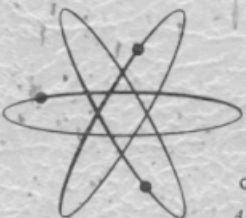

Copyright © 1969
Heath Company
All rights reserved











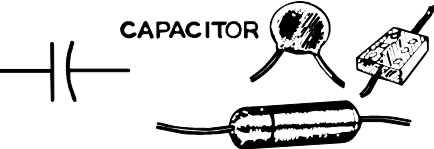
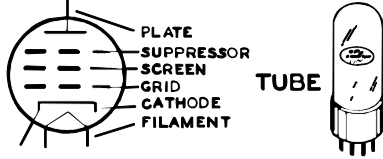
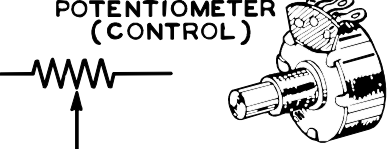
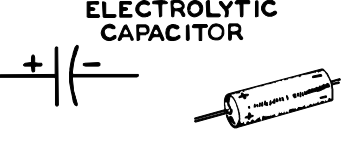
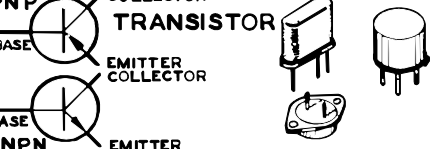
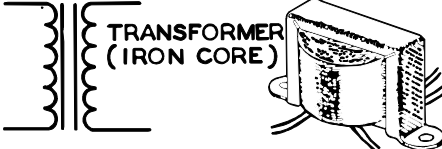

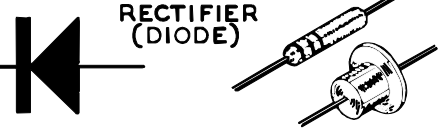
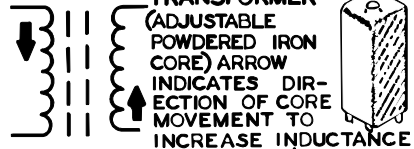
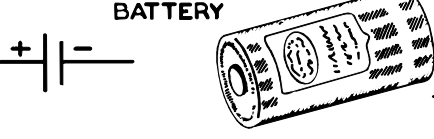
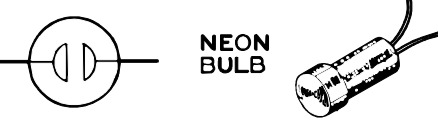
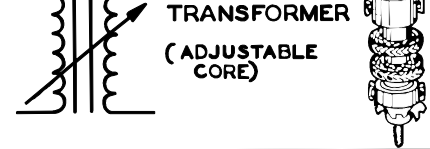
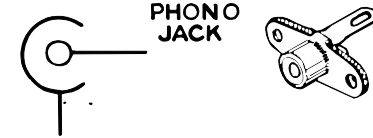

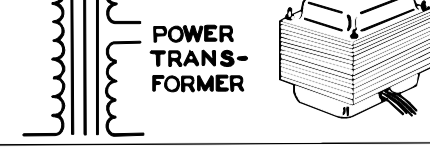

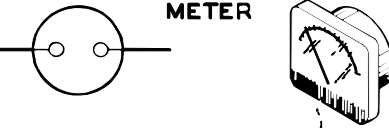
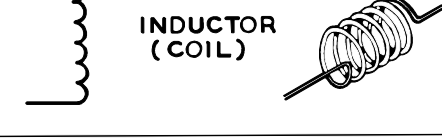
created using
BCL easyPDF
Printer Driver

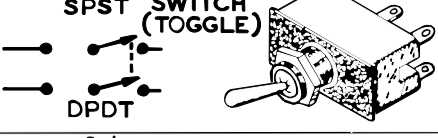
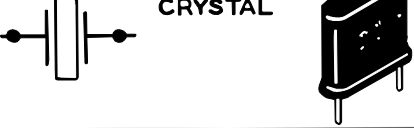
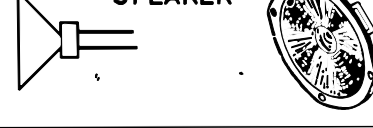
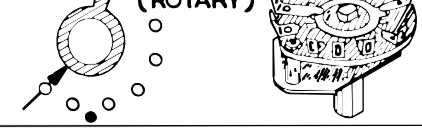
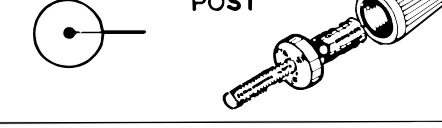
TYPICAL COMPONENT TYPES

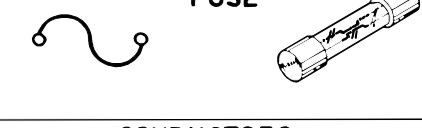
This chart is a guide to commonly used types of electronic components. The symbols and related illustrations

should prove helpful in identifying most parts and reading the schematic diagrams.

<p style="text-align: center;">RESISTOR</p> 	<p style="text-align: center;">CAPACITOR</p> 	<p style="text-align: center;">TUBE</p> 
<p style="text-align: center;">POTENTIOMETER (CONTROL)</p> 	<p style="text-align: center;">ELECTROLYTIC CAPACITOR</p> 	<p style="text-align: center;">TRANSISTOR</p> 
<p style="text-align: center;">TRANSFORMER (IRON CORE)</p> 	<p style="text-align: center;">VARIABLE CAPACITOR</p> 	<p style="text-align: center;">RECTIFIER (DIODE)</p> 
<p style="text-align: center;">TRANSFORMER (ADJUSTABLE POWDERED IRON CORE) ARROW INDICATES DIRECTION OF CORE MOVEMENT TO INCREASE INDUCTANCE</p> 	<p style="text-align: center;">BATTERY</p> 	<p style="text-align: center;">NEON BULB</p> 
<p style="text-align: center;">TRANSFORMER (ADJUSTABLE CORE)</p> 	<p style="text-align: center;">PHONO JACK</p> 	<p style="text-align: center;">ILLUMINATING BULB</p> 
<p style="text-align: center;">POWER TRANSFORMER</p> 	<p style="text-align: center;">PHONE JACK</p> 	<p style="text-align: center;">METER</p> 
<p style="text-align: center;">INDUCTOR (COIL)</p> 	<p style="text-align: center;">RECEPTACLE</p> 	<p style="text-align: center;">SWITCH (TOGGLE)</p> 
<p style="text-align: center;">PIEZOELECTRIC CRYSTAL</p> 	<p style="text-align: center;">SPEAKER</p> 	<p style="text-align: center;">SWITCH (ROTARY)</p> 
<p style="text-align: center;">BINDING POST</p> 	<p style="text-align: center;">MICROPHONE</p> 	<p style="text-align: center;">FUSE</p> 
<p style="text-align: center;">ANTENNA</p> 	<p style="text-align: center;">EARTH GROUND</p>  <p style="text-align: center;">CHASSIS GROUND</p> 	<p style="text-align: center;">CONDUCTORS</p>  <p style="text-align: center;">NOT CONNECTED CONNECTED SHIELDED</p>



Assembly and Operation

of the



TV POST-MARKER/ SWEEP GENERATOR

MODEL IG-57A



HEATH COMPANY
BENTON HARBOR, MICHIGAN 49022



created using
BCL easyPDF
Printer Driver

TABLE OF CONTENTS

INTRODUCTION.	3
PARTS LIST.	5
STEP-BY-STEP ASSEMBLY	
Circuit Board.	9
Sweep-Shield.	21
Chassis.	24
Front-Panel.	26
Rear Panel.	32
Chassis Final Assembly.	34
Installing Knobs.	36
Chassis Wiring	
Chassis Bottom.	38
Chassis Top.	39
VSM.	43
Preparing Cables.	44
Preparing Leads.	50
Attenuator Assembly And Wiring.	52
Wiring.	55
Attenuator Final Assembly.	56
TESTS AND ADJUSTMENTS.	57
FINAL ASSEMBLY.	63
APPLICATIONS.	67
TV Alignment.	68
FM Alignment.	74
Heathkit Model Alignment.	75
IN CASE OF DIFFICULTY.	85
Troubleshooting Chart.	86
ATTENUATOR RESISTANCE CHECK.	91
SPECIFICATIONS.	93
CIRCUIT DESCRIPTION.	95
EXTERNAL GENERATOR	
Requirements.	103
Connecting External Generators.	105
CHASSIS PHOTOGRAPHS.	107
CIRCUIT BOARD X-RAY VIEWS.	111
REPLACEMENT PARTS PRICE LIST.	113
SCHEMATIC. . . (fold-out from page).	117

HEATHKIT®

INTRODUCTION

The Heathkit Model IG-57A TV Post-Marker/Sweep Generator is a solid-state fifteen-crystal marker generator and electronic sweep generator for alignment of tuned circuits in color or black and white TV sets, and FM receivers.

The Post Marker Generator mixes one or more marker signals with the demodulated signal from the circuit being tested or aligned. The markers are sharp and well defined and will not alter or distort the response curve of the circuits involved. Therefore, the oscilloscope will show the actual waveshape of the circuit or device under test.

As many as six markers can be made to appear simultaneously on an IF trace. This enables you to adjust the IF circuits for proper waveshape and bandwidth in much less time than would be possible if you were to use the old variable marker system which must be reset and calibrated for each marker frequency.

Markers are provided for color bandpass alignment; picture and sound carrier frequencies for channels 4 and 10; FM tuner, FM IF, and discriminator alignment; and television sound IF adjustments. Modulation at 400 Hz is provided for trap adjustment and for checking and adjusting FM tuners. Also provided are two variable voltage bias supplies, with switch-selector to provide positive or negative voltages.

The Sweep Generator has three linear sweep ranges. These ranges cover the sweep necessary for proper alignment of FM receivers and the TV tuned circuits in the sound IF, color bandpass, and video IF circuits, and for proper overall RF/IF response.

The diode modulator combines the frequencies of the post-marker and sweep generators to permit amplitude modulation of the picture carrier frequency by a low frequency sweep signal. This method of sweep alignment, called Video Sweep Modulation, permits observation of the overall color bandpass response, including the effect of the video detector load circuitry.

Other features include a blanking switch, trace reversing switch, and a phase control so the markers will appear as shown in the waveforms in the set manufacturer's alignment instructions regardless of the oscilloscope you use.

All of these features combine to provide you with a versatile, accurate, and attractive test instrument that is designed for long and dependable service at minimum cost.

Refer to the "Kit Builders Guide" for complete information on unpacking, parts identification, tools, wiring, soldering, and step-by-step assembly procedures.

PARTS PIC

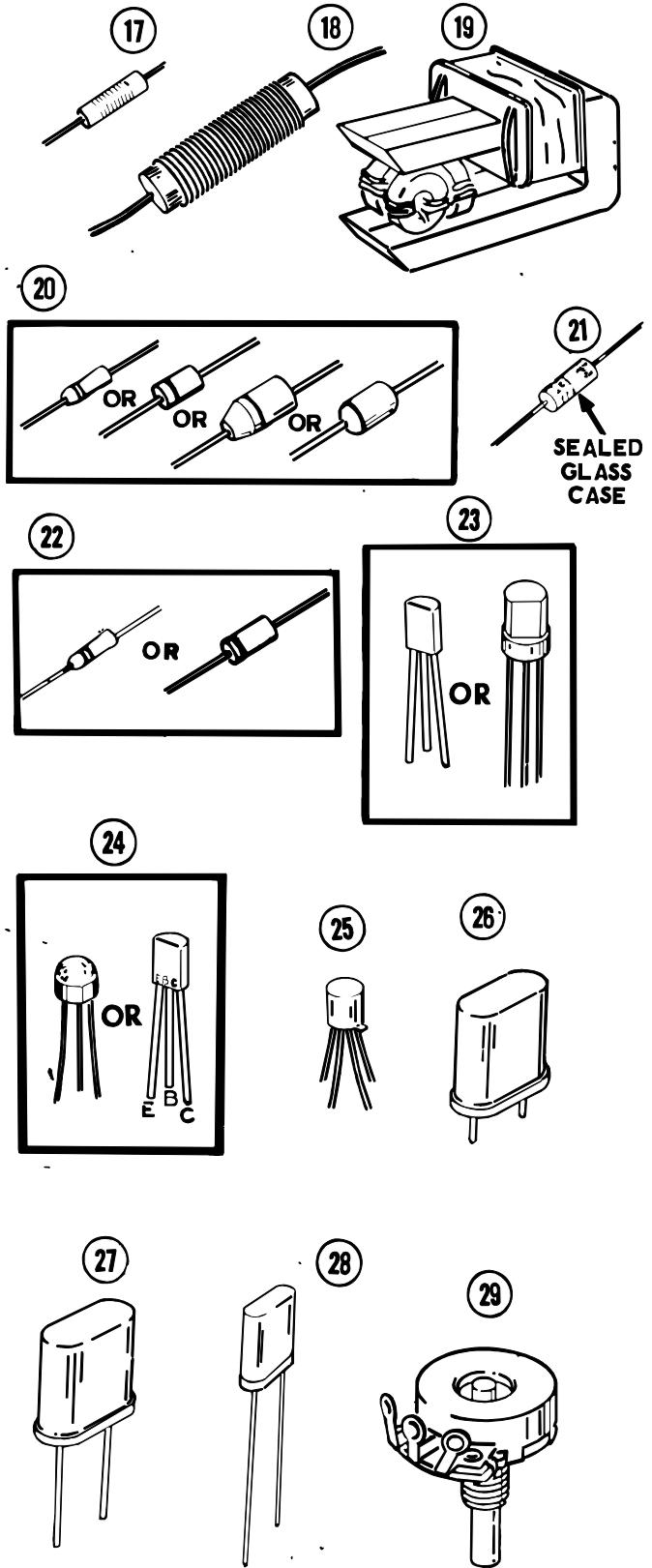
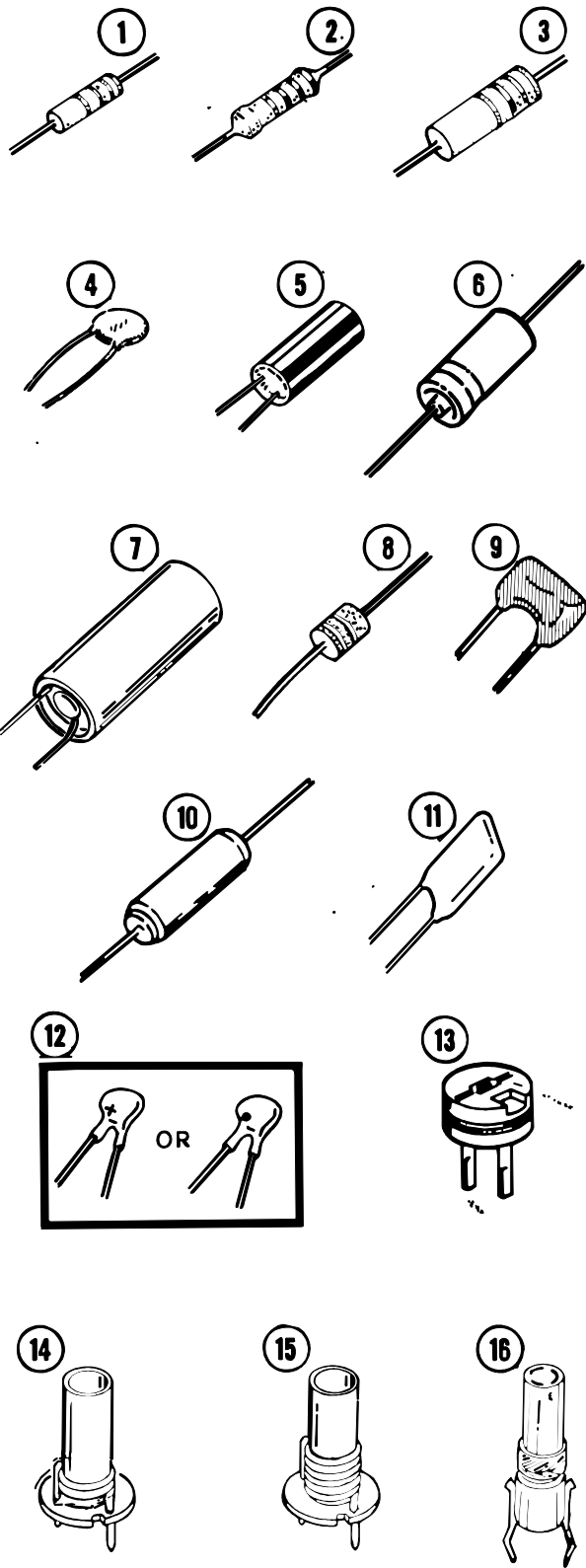

PICTORIAL-A

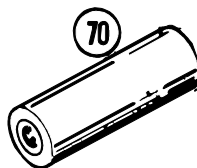
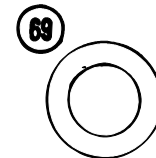
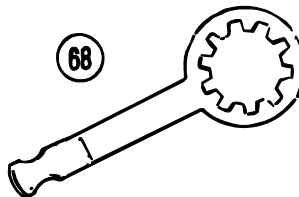
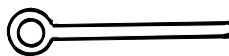
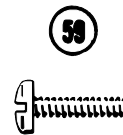
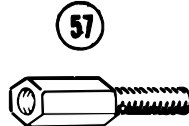
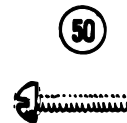
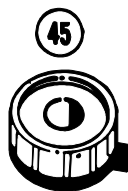
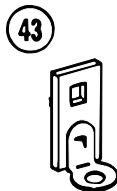
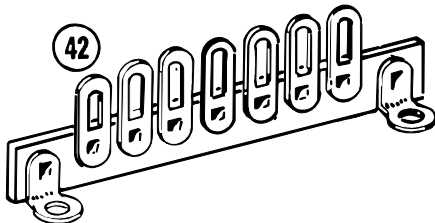
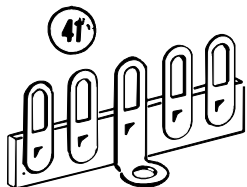
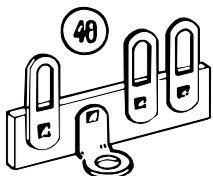
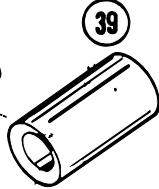
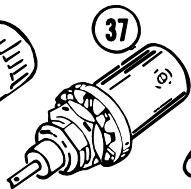
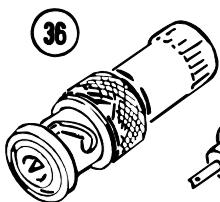
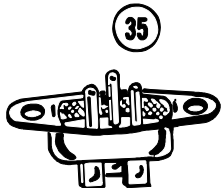
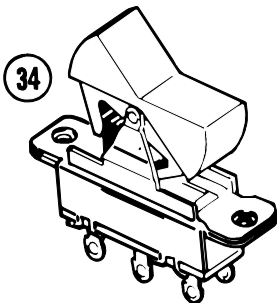
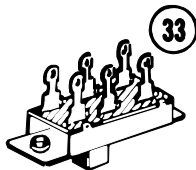
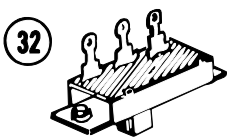
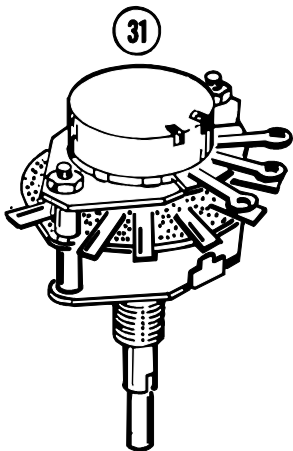
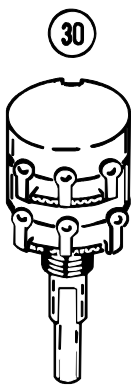

PARTS LIST

To order replacement parts, refer to the Replacement Parts Price List and use the Parts Order Form furnished with this kit.

The numbers in parentheses are keyed to the numbers on the Parts Pictorials (fold-out from Page 4).

<u>PART No.</u>	<u>PARTS Per Kit</u>	<u>DESCRIPTION</u>	<u>PART No.</u>	<u>PARTS Per Kit</u>	<u>DESCRIPTION</u>
RESISTORS			1/2 Watt (cont'd.)		
1/2 Watt			1-31	1	330 kΩ (orange-orange-yellow)
(1)1-130	1	8.2 Ω (gray-red-gold)	1-32	1	390 kΩ (orange-white-yellow)
1-49	1	22 Ω (red-red-black)	1-37	1	2.2 MΩ (red-red-green)
1-146	4	75 Ω (violet-green-black)			
1-3	27	100 Ω (brown-black-brown)	1/2 Watt Low-Noise		
1-66	1	150 Ω (brown-green-brown)	(2)4-69	1	27 Ω, 5% (red-violet-black)
1-45	18	220 Ω (red-red-brown)	4-70	1	56 Ω, 5% (green-blue-black)
1-42	1	270 Ω (red-violet-brown)	4-9	4	91 Ω, 5% (white-brown-black)
1-6	1	470 Ω (yellow-violet-brown)	4-57	2	100 Ω, 5% (brown-black-brown)
1-7	2	680 Ω (blue-gray-brown)	4-58	4	150 Ω, 5% (brown-green-brown)
1-9	7	1000 Ω (brown-black-red)	4-59	2	220 Ω, 5% (red-red-brown)
1-11	5	1500 Ω (brown-green-red)	4-12	2	390 Ω, 5% (orange-white-brown)
1-44	2	2200 Ω (red-red-red)	4-71	2	430 Ω, 5% (yellow-orange-brown)
1-13	2	2700 Ω (red-violet-red)	4-72	2	1300 Ω, 5% (brown-orange-red)
1-16	9	4700 Ω (yellow-violet-red)			
1-19	3	6800 Ω (blue-gray-red)	1 Watt		
1-73	6	8200 Ω (gray-red-red)	(3)1-17-1	2	100 Ω (brown-black-brown)
1-20	5	10 kΩ (brown-black-orange)			
1-109	1	12 kΩ (brown-red-orange)			
1-21	1	15 kΩ (brown-green-orange)			
1-22	4	22 kΩ (red-red-orange)			
1-23	2	27 kΩ (red-violet-orange)			
1-67	2	39 kΩ (orange-white-orange)			
1-25	6	47 kΩ (yellow-violet-orange)			
1-47	9	56 kΩ (green-blue-orange)			
1-60	2	68 kΩ (blue-gray-orange)			
1-26	1	100 kΩ (brown-black-yellow)			
1-121	2	120 kΩ (brown-red-yellow)			



PART No.	PARTS Per Kit	DESCRIPTION
----------	---------------	-------------

PART No.	PARTS Per Kit	DESCRIPTION
----------	---------------	-------------

CAPACITORS

Disc			
(4) 21-3	11	10 pF	
21-60	5	18 pF	
21-84	5	24 pF	
21-7	6	33 pF	
21-32	1	47 pF	
21-85	2	56 pF	
21-96	3	85 pF	
21-9	1	100 pF	
21-11	1	150 pF	
21-21	2	200 pF	
21-17	3	270 pF	
21-56	2	470 pF	
21-13	1	500 pF	
21-14	13	.001 μ F	
21-26	3	.003 μ F	
21-27	9	.005 μ F	
21-72	4	.005 μ F, 1.4 kV (1400 V)	
21-47	21	.01 μ F	

Electrolytic

(5) 25-149	2	5 μ F
25-115	1	10 μ F
(6) 25-145	1	25 μ F
(7) 25-194	2	100 μ F
25-193	2	250 μ F

Other Capacitors

(8) 28-2	1	1 pF phenolic (brown-black-white-silver)
(9) 20-99	2	22 pF resin
20-124	1	115 pF resin
20-104	1	130 pF resin
20-107	1	680 pF resin
(10) 29-8	1	3300 pF
(11) 27-73	3	.047 μ F Mylar*
27-47	6	.1 μ F Mylar
(12) 25-200	1	.68 μ F, 35 V Tantalum
(13) 31-36	2	8 to 50 pF trimmer

COILS-CHOKES-INDUCTOR-TRANSFORMER

(14) 40-478	2	Oscillator coil (brown)
(15) 40-479	8	Oscillator coil (red)
(16) 40-820	1	100 kHz oscillator coil
45-76	1	1.2 μ H choke
(17) 45-39	1	4.7 μ H choke
(18) 45-6	2	8.2 μ H choke
(19) 403-3	1	Controllable inductor
54-191	1	Power transformer

DIODES-TRANSISTORS

NOTE: The physical appearance of several of the following diodes may vary as indicated by the Parts Pictorial.

(20) 57-27	3	Silicon diode**
(21) 56-26	3	Crystal diode
(22) 56-32	1	13.6 V zener diode**
56-45	1	20 V zener diode**
(23) 417-118	6	2N3393 transistor
417-94	1	2N3416 transistor
(24) 417-108	18	2N3692 transistor
(25) 417-133	2	40245 transistor

CRYSTALS

(26) 404-332	1	3.080 MHz
404-333	1	4.080 MHz
404-4	1	4.5 MHz (4500 kHz)
404-39	1	10.7 MHz
(27) 404-238	1	3.579 MHz (3579.545 kHz)
(28) 404-334	1	39.750 MHz
404-335	1	41.250 MHz
404-336	1	42.170 MHz
404-337	1	42.500 MHz
404-344	1	42.750 MHz
404-338	1	45.000 MHz
404-339	1	45.750 MHz
404-340	1	47.250 MHz
404-341	1	67.250 MHz
404-342	1	96.625 MHz

CONTROLS-SWITCHES

(29) 10-11	1	50 k Ω control
(30) 12-92	1	5 k Ω /10 k Ω dual concentric control
12-91	1	10 k Ω /1 M Ω dual concentric control
12-102	1	20 k Ω /20 k Ω dual concentric control
(31) 63-483	1	Wafer switch with 100 Ω control
(32) 60-4	2	Slide switch, SPDT
(33) 60-2	2	Slide switch, DPDT
(34) 60-48	24	Rocker switch, DPDT (RF)

*DuPont Registered Trademark

**Stamped with the Heath part number.



PART **PARTS** **DESCRIPTION**
No. **Per Kit**

PART **PARTS** **DESCRIPTION**
No. **Per Kit**

CONNECTOR-PLUGS-INSULATORS-STRIPS

#6 Hardware

(35) 432-76 1 AC connector
 (36) 432-58 6 Coaxial plug
 (37) 432-59 8 Coaxial connector
 (38) 438-13 8 Banana plug
 (39) 70-5 4 Plug insulator (black)
 70-6 4 Plug insulator (red)
 (40) 431-3 1 3-lug terminal strip
 (41) 431-11 2 5-lug terminal strip
 (42) 431-35 1 7-lug terminal strip
 (43) 431-73 1 Terminal strip

(53) 250-116 4 6-32 x 1/4" black screw
 (54) 250-56 33 6-32 x 1/4" screw
 (55) 250-229 12 6-32 x 1/4" phillips head screw
 (56) 250-303 4 6-32 x 1/4" decorative head screw
 (57) 250-304 4 6-32 x 7/16" spacer stud
 (58) 250-89 2 6-32 x 3/8" screw
 (59) 250-162 7 6-32 x 1/2" screw
 (60) 252-3 31 6-32 nut
 (61) 250-8 12 #6 x 3/8" sheet metal screw
 (62) 250-155 6 #6 x 3/8" black sheet metal screw
 (63) 254-1 34 #6 lockwasher
 (64) 259-1 9 #6 solder lug

KNOBS-BUSHINGS

(44) 462-82 1 Black knob
 (45) 462-247 4 Concentric knob with pointer
 (46) 455-52 4 Bushing for knob #462-247
 (47) 462-276 4 Small knob with color dot
 (48) 455-51 4 Bushing for knob #462-276

Other Hardware

(65) 259-24 4 #8 long lug
 (66) 252-7 5 Control nut
 (67) 254-4 4 Control lockwasher
 (68) 259-10 7 Control solder lug
 (69) 253-10 5 Control flat washer
 (70) 255-21 4 7/8" spacer
 (71) 252-9 1 Speednut
 (72) 427-3 5 Binding post base

CABLE-WIRE-SLEEVEING

347-1 1 8-wire cable
 89-30 1 Line cord with plugs
 343-7 1 Small coaxial cable
 343-9 1 Large coaxial cable
 341-1 1 Large black stranded wire
 341-2 1 Large red stranded wire
 344-50 1 Black wire
 344-52 1 Red wire
 344-53 1 Orange wire
 344-54 1 Yellow wire
 344-56 1 Blue wire
 344-59 1 White wire
 340-3 1 Large bare wire

The following numbers in parentheses are keyed to the numbers on Parts Pictorial B (fold-out from Page 9).

METAL PARTS

HARDWARE

#4 Hardware

(49) 250-52 70 4-40 x 1/4" screw
 (50) 250-34 2 4-40 x 1/2" screw
 (51) 252-2 22 4-40 nut
 (52) 254-9 30 #4 lockwasher

(1) 200-515 1 Chassis
 (2) 100-932 1 Front panel
 (3) 100-947 1 Rear panel
 (4) 90-374-1 2 Cabinet half-shell
 (5) 204-812 2 Siderail
 (6) 204-759-1 4 End cap
 (7) 204-811 1 Switch bracket
 (8) 210-35 1 Bezel
 (9) 206-383 1 Sweep shield
 (10) 205-591 1 Shield cover
 (11) 205-727 1 Shield plate
 (12) 90-398-1 1 Attenuator top shell
 (13) 90-397 1 Attenuator bottom shell
 (14) 206-384 1 Attenuator shield
 (15) 206-385 3 Switch shield



<u>PART No.</u>	<u>PARTS Per Kit</u>	<u>DESCRIPTION</u>	<u>PART No.</u>	<u>PARTS Per Kit</u>	<u>DESCRIPTION</u>
MISCELLANEOUS			Miscellaneous (cont'd.)		
85-192-2	1	Amplifier circuit board	75-15	2	Terminal shell (drilled)
85-193-3	1	Oscillator circuit board	75-106	1	Terminal shell (RF)
85-233-1	1	Sweep circuit board	(26)75-87	8	Nylon feedthrough
(16)73-34	8	Clip insulator	(27)204-135	4	Angle bracket
(17)75-17	10	Insulator bushing	(28)207-19	1	5/16" cable clamp
(18)100-16-2	2	Black binding post cap	(29)211-34	2	Handle
100-16-18	3	Red binding post cap	(30)490-1	1	Alignment tool
(19)413-10	1	Red lens	(31)490-5	1	Nut starter
(20)412-15	1	Neon lamp (NE2H)	(32)391-34	1	Blue and white label
(21)260-16	12	Alligator clip	432-27	1	AC plug adapter
(22)261-28	4	Large plastic foot	597-260	1	Parts Order Form
261-29	4	Small plastic foot	597-308	1	Kit Builders Guide
(23)259-7	4	Spade lug		1	Manual (See front cover for part number.)
(24)73-53	1	Rubber grommet			Solder
(25)75-111	1	Terminal shell (DEM0D)			



STEP-BY-STEP ASSEMBLY

CIRCUIT BOARD

Before starting to assemble the circuit boards, be sure you have read the wiring, soldering, and step-by-step assembly information in the Kit Builders Guide.

Position all parts as shown in the Pictorials. Follow the instructions carefully, and read the entire step before performing the operation.

Use 1/2 watt resistors unless directed otherwise in a step. Resistors will be called out by the color code and the resistance value in Ω (ohms),

$k\Omega$ (kilohms), or $M\Omega$ (megohms). Capacitors will be called out by the capacitance value (in μF or pF) and type.

Perform each step in the order listed and complete each Pictorial before proceeding to the next Pictorial. When the circuit board is finished, set it aside until it is called for later on in the assembly instructions.

NOTE: Do not use the 1/2 watt low-noise resistors, or the .005 μF 1.4 kV disc capacitors until directed to do so in a step.



PARTS PICTORIAL - B

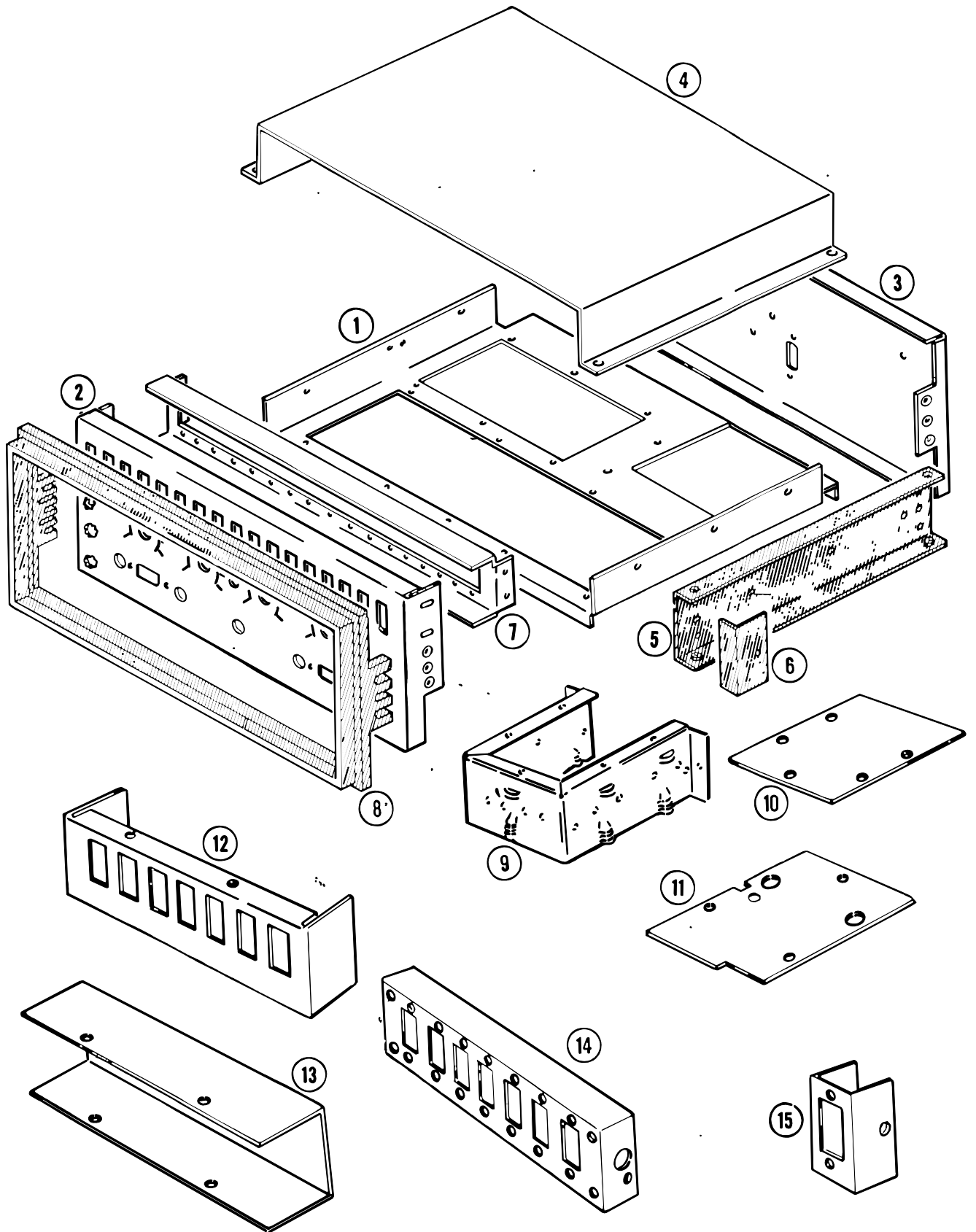

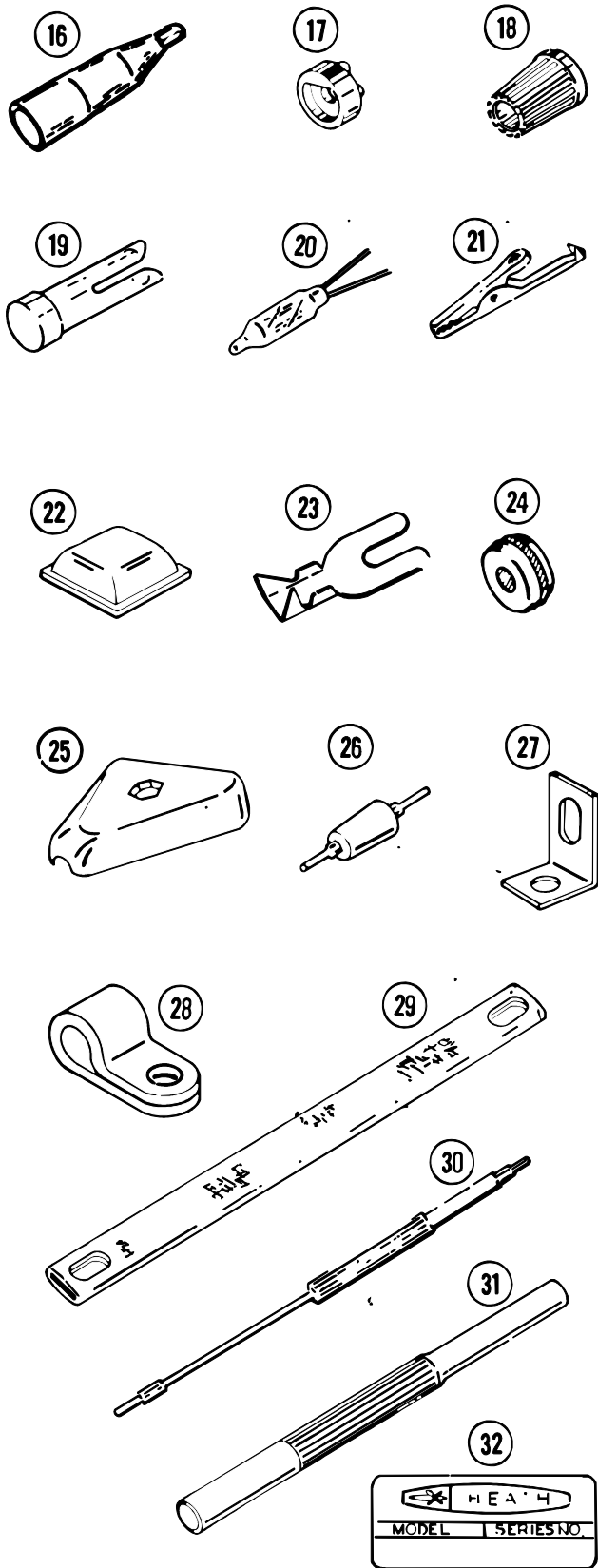

START



() Position the amplifier circuit board (#85-192-2) lettered side up as shown in the following Pictorials.

NOTE: Do not solder the leads until directed to do so in a step.

() 2.2 MΩ (red-red-green).

() 1000 Ω (brown-black-red).

(✓) 390 kΩ (orange-white-yellow).

(✓) 10 kΩ (brown-black-orange).

(✓) 12 kΩ (brown-red-orange).

(✓) 120 kΩ (brown-red-yellow).

() 100 Ω (brown-black-brown).

(✓) Solder all leads to the foil and cut off the excess lead lengths.

(✓) 2700 Ω (red-violet-red).

(✓) Prepare a resistor-capacitor combination as shown below. Use a 2700 Ω (red-violet-red) resistor and a 56 pF disc capacitor.

CUT OFF EXCESS RESISTOR LEADS

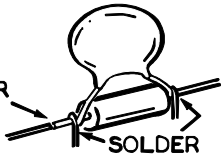

SOLDER

() 680 Ω (blue-gray-brown).

() 330 kΩ (orange-orange-yellow).

() 100 Ω (brown-black-brown).

NOTE: When installing diodes, the cathode end must be positioned as shown on the circuit board. The cathode end is marked with either a color band or bands.

(✓) Silicon diode (#57-27).

(✓) Silicon diode (#57-27).

() Solder all leads to the foil and cut off the excess lead lengths.

FOR GOOD SOLDERED CONNECTIONS, YOU MUST KEEP THE SOLDERING IRON TIP CLEAN... WIPE IT OFTEN WITH A DAMP SPONGE OR CLOTH.

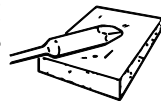

CONTINUE

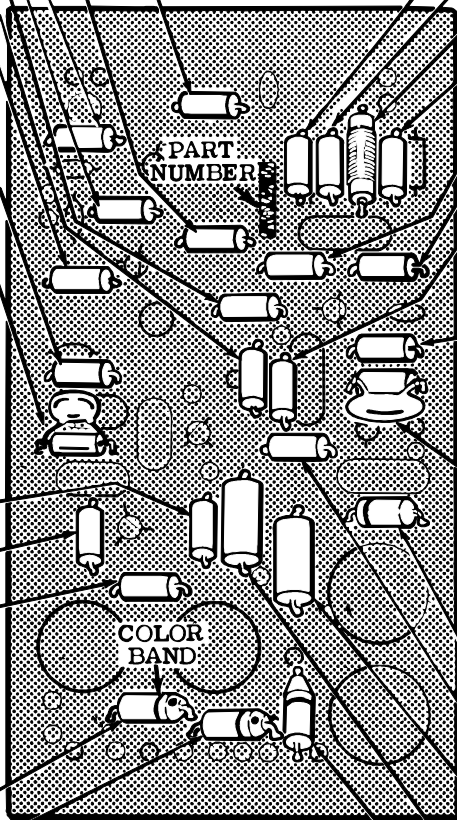

(✓) 100 Ω (brown-black-brown).

(✓) 100 Ω (brown-black-brown).

(✓) 4.7 μH choke (#45-39).

(✓) 100 Ω (brown-black-brown).

() 120 kΩ (brown-red-yellow).

() 10 kΩ (brown-black-orange).

() 68 kΩ (blue-gray-orange).

(✓) Solder all leads to the foil and cut off the excess lead lengths.

() 1000 Ω (brown-black-red).

(✓) Prepare a resistor-capacitor combination as shown below. Use a 10 kΩ (brown-black-orange) resistor and a .01 μF disc capacitor.

CUT OFF EXCESS RESISTOR LEADS

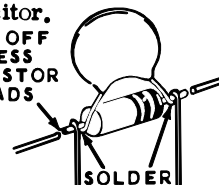

SOLDER

() Zener diode (#56-32).

() 1000 Ω (brown-black-red).

() 100 Ω 1 watt (brown-black-brown).

() 100 Ω 1 watt (brown-black-brown).

(✓) Silicon diode (#57-27).

() Solder all leads to the foil and cut off the excess lead lengths.

PROCEED TO PICTORIAL 2.

PICTORIAL 1

START



NOTE: Do not solder the leads until directed to do so in a step.

- () 2N3393 transistor (#417-118) at Q19 as shown.

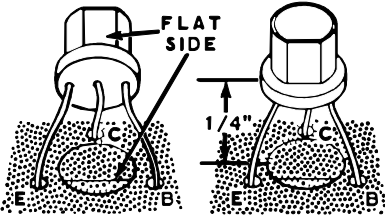

- () .01 μ F disc.
- () .01 μ F disc.
- () 2N3393 transistor (#417-118) at Q20.

- () .01 μ F disc.
- () .047 μ F Mylar.
- () .047 μ F Mylar.
- () .047 μ F Mylar.

- () 5 μ F electrolytic. **NOTE:** When mounting electrolytic capacitors, always insert the positive (+) lead of the capacitor into the positive (+) hole in the circuit board.

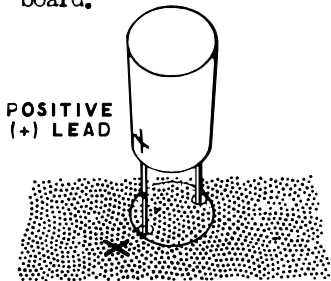

- () Solder the leads to the foil and cut off the excess lead lengths.
- () 100 μ F electrolytic. Note position of positive lead.
- () 2N3393 transistor (#417-118) at Q22.
- () 100 μ F electrolytic. Note position of positive lead.
- () Solder the leads to the foil and cut off the excess lead lengths.

CONTINUE



- () 5 μ F electrolytic. Note position of positive lead.
- () .001 μ F disc.
- () .1 μ F Mylar.

- () Position the 40245 transistor (#417-133) as shown and cut off the "S" lead. Then insert the E, B and C leads in their proper holes in the circuit board at Q17 and solder the leads to the foil.

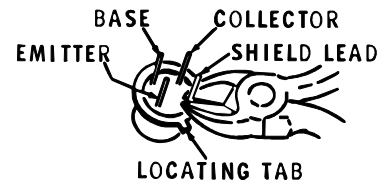

- () .68 μ F Tantalum capacitor. **NOTE:** Position the positive (+) lead or color dot as shown.

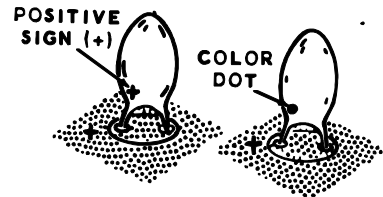

- () .1 μ F Mylar.
- () 2N3393 transistor (#417-118) at Q18.
- () .1 μ F Mylar.

- () 250 μ F electrolytic. Note position of positive lead.
- () 250 μ F electrolytic. Note position of positive lead.
- () 2N3393 transistor (#417-118) at Q21.

- () Solder the leads to the foil and cut off the excess lead lengths.

Set the amplifier circuit board aside. It will be used later.

PROCEED TO PICTORIAL 3.

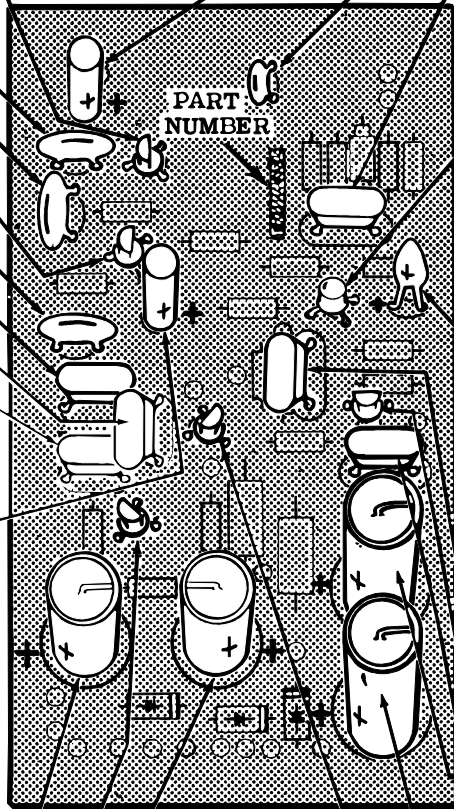

PICTORIAL 2

The steps performed in this Pictorial are in this area of the circuit board.

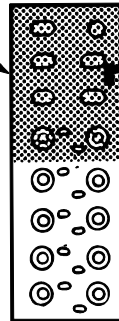

PART NUMBER

START



() Position the oscillator circuit board (#85-193-2) lettered side up as shown in the following Pictorials.

NOTE: Do not solder the leads until directed to do so in a step.

- () 1500 Ω (brown-green-red).
- () 220 Ω (red-red-brown).
- () 8200 Ω (gray-red-red).
- () 47 kΩ (yellow-violet-orange).
- () 100 Ω (brown-black-brown).
- () 1500 Ω (brown-green-red).
- () 220 Ω (red-red-brown).
- () 8200 Ω (gray-red-red).
- () 47 kΩ (yellow-violet-orange).
- () Solder the leads to the foil and cut off the excess lead lengths.
- () 100 Ω (brown-black-brown).
- () 1500 Ω (brown-green-red).
- () 220 Ω (red-red-brown).
- () 47 kΩ (yellow-violet-orange).
- () 100 Ω (brown-black-brown).
- () 56 kΩ (green-blue-orange).
- () 8200 Ω (gray-red-red).
- () 4700 Ω (yellow-violet-red).
- () 220 Ω (red-red-brown).
- () Solder the leads to the foil and cut off the excess lead lengths.

CONTINUE

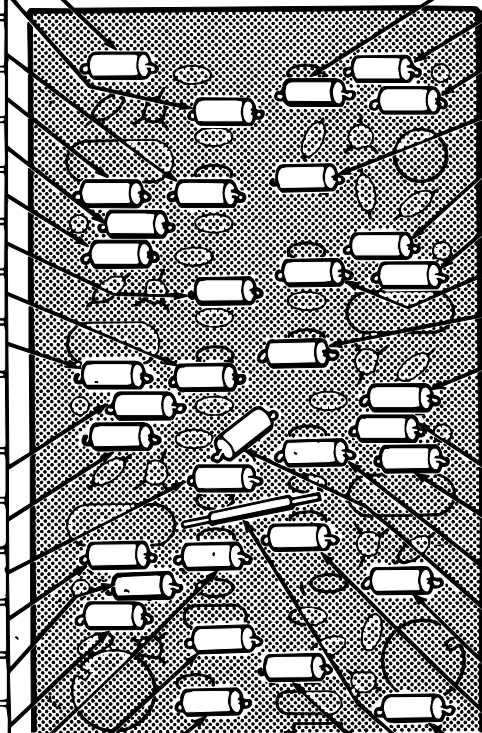

- () 8200 Ω (gray-red-red).
- () 100 Ω (brown-black-brown).
- () 15 kΩ (brown-green-orange).
- () 1500 Ω (brown-green-red).
- () 100 Ω (brown-black-brown).
- () 47 kΩ (yellow-violet-orange).
- () 8200 Ω (gray-red-red).
- () 220 Ω (red-red-brown).
- () 1500 Ω (brown-green-red).
- () Solder the leads to the foil and cut off the excess lead lengths.
- () 100 Ω (brown-black-brown).
- () 47 kΩ (yellow-violet-orange).
- () 8200 Ω (gray-red-red).
- () 1000 Ω (brown-black-red).
- () 1000 Ω (brown-black-red).
- () 220 Ω (red-red-brown).
- () 56 kΩ (green-blue-orange).
- () 1" white wire.
- () 220 Ω (red-red-brown).
- () Solder the leads to the foil and cut off the excess lead lengths.

PICTORIAL 3

PROCEED TO PICTORIAL 4.

START

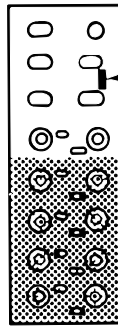

PART NUMBER

The steps performed in this Pictorial are in this area of the circuit board.

CONTINUE



- NOTE: Do not solder the leads until directed to do so in a step.
- () 100 Ω (brown-black-brown).
 - () 4700 Ω (yellow-violet-red).
 - () 56 kΩ (green-blue-orange).
 - () 220 Ω (red-red-brown).
 - () 100 Ω (brown-black-brown).
 - () 56 kΩ (green-blue-orange).
 - () 4700 Ω (yellow-violet-red).
 - () 220 Ω (red-red-brown).
 - () 100 Ω (brown-black-brown).
 - () Solder the leads to the foil and cut off the excess lead lengths.
 - () 56 kΩ (green-blue-orange).
 - () 4700 Ω (yellow-violet-red).
 - () 220 Ω (red-red-brown).
 - () 100 Ω (brown-black-brown).
 - () 56 kΩ (green-blue-orange).
 - () 4700 Ω (yellow-violet-red).
 - () 220 Ω (red-red-brown).
 - () 100 Ω (brown-black-brown).
 - () 1-1/4" white wire.
 - () Solder the leads to the foil and cut off the excess lead lengths.

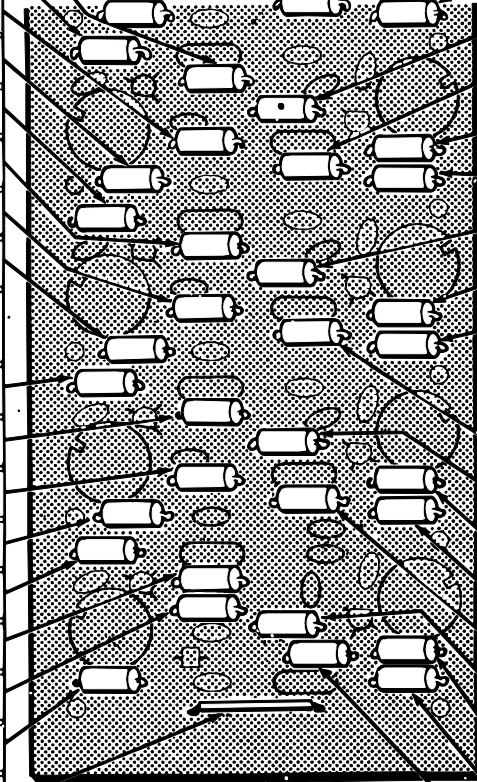

- () 4700 Ω (yellow-violet-red).
- () 100 Ω (brown-black-brown).
- () 220 Ω (red-red-brown).
- () 4700 Ω (yellow-violet-red).
- () 56 kΩ (green-blue-orange).
- () 100 Ω (brown-black-brown).
- () 220 Ω (red-red-brown).
- () 56 kΩ (green-blue-orange).
- () 100 Ω (brown-black-brown).
- () Solder the leads to the foil and cut off the excess lead lengths.
- () 4700 Ω (yellow-violet-red).
- () 220 Ω (red-red-brown).
- () 56 kΩ (green-blue-orange).
- () 100 Ω (brown-black-brown).
- () 4700 Ω (yellow-violet-red).
- () 150 Ω (brown-green-brown).
- () 22 kΩ (red-red-orange).
- () 100 Ω (brown-black-brown).
- () 6800 Ω (blue-gray-red).
- () Solder the leads to the foil and cut off the excess lead lengths.

PICTORIAL 4

PROCEED TO PICTORIAL 5.

The steps performed in this Pictorial are in this area of the circuit board.

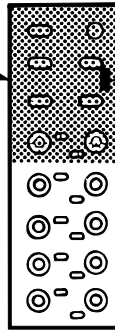

PART NUMBER

START



CONTINUE



NOTE: Do not solder the leads until directed to do so in a step.

- () 18 pF disc.
- () .01 μ F disc.
- () 85 pF disc.
- () 270 pF disc.
- () .01 μ F disc.
- () 18 pF disc.
- () 24 pF disc.
- () .01 μ F disc.
- () Solder the leads to the foil and cut off the excess lead lengths.
- () 270 pF disc.
- () 85 pF disc.
- () .01 μ F disc.
- () 18 pF disc.
- () .01 μ F disc.
- () 33 pF disc.
- () 270 pF disc.
- () .01 μ F disc.
- () 10 pF disc.
- () Solder the leads to the foil and cut off the excess lead lengths.

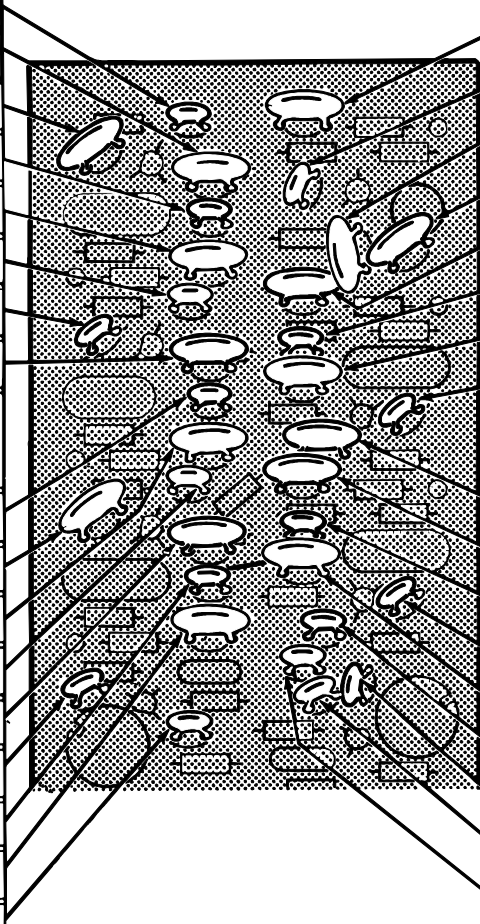

- () .01 μ F disc.
- () 500 pF disc.
- () .003 μ F disc.
- () .003 μ F disc.
- () .01 μ F disc.
- () 470 pF disc.
- () .01 μ F disc.
- () 10 pF disc.
- () Solder the leads to the foil and cut off the excess lead lengths.
- () 56 pF disc.
- () .01 μ F disc.
- () 100 pF disc.
- () 85 pF disc.
- () .01 μ F disc.
- () 10 pF disc.
- () 33 pF disc.
- () 10 pF disc.
- () .001 μ F disc.
- () Solder the leads to the foil and cut off the excess lead lengths.

PROCEED TO PICTORIAL 6.

PICTORIAL 5

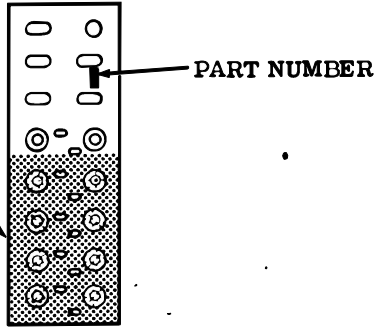

The steps performed in this Pictorial are in this area of the circuit board.

START
↓

NOTE: Do not solder the leads until directed to do so in a step.

- () .001 μ F disc.
- () 33 pF disc.
- () 10 pF disc.
- () .001 μ F disc.
- () 10 pF disc.
- () 33 pF disc.
- () .001 μ F disc.
- () Solder the leads to the foil and cut off the excess lead lengths.
- () 24 pF disc.
- () 10 pF disc.
- () .001 μ F disc.
- () 47 pF disc.
- () 18 pF disc.
- () 1 pF phenolic.
- () .001 μ F disc.
- () Solder the leads to the foil and cut off the excess lead lengths.

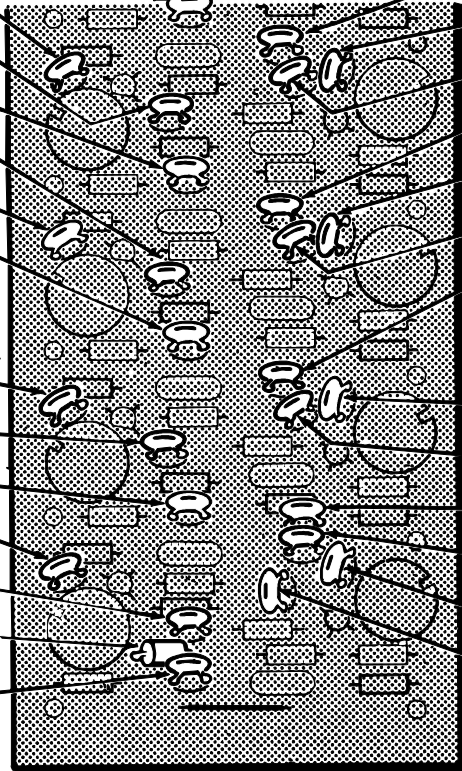

CONTINUE
↓

- () .001 μ F disc.
- () 33 pF disc.
- () 10 pF disc.
- () .001 μ F disc.
- () 33 pF disc.
- () 10 pF disc.
- () .001 μ F disc.
- () Solder the leads to the foil and cut off the excess lead lengths.
- () 24 pF disc.
- () 10 pF disc.
- () 24 pF disc.
- () .001 μ F disc.
- () 24 pF disc.
- () 10 pF disc.
- () Solder the leads to the foil and cut off the excess lead lengths.

PROCEED TO PICTORIAL 7.

PICTORIAL 6

FOR GOOD SOLDERED CONNECTIONS, YOU MUST KEEP THE SOLDERING IRON TIP CLEAN... WIPE IT OFTEN WITH A DAMP SPONGE OR CLOTH.

CONTINUE

START

NOTE: Transistors may come in either of the physical shapes shown below. First identify the transistor shape by the illustration, and note the difference. Orient the leads to the holes, and insert leads C, B, and E into the corresponding C, B, and E holes in the circuit board. Place the transistor 1/4" above the circuit board. Solder the leads of each transistor as it is installed, then cut off the excess lead lengths.

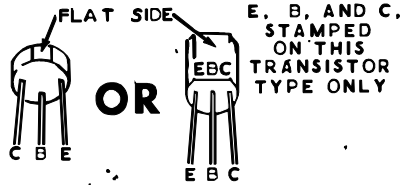

- 2N3692 transistor (#417-108) at Q11.
- 2N3692 transistor at Q9.
- 2N3692 transistor at Q7.
- 2N3692 transistor at Q5.
- 2N3692 transistor at Q3.
- 2N3692 transistor at Q1.

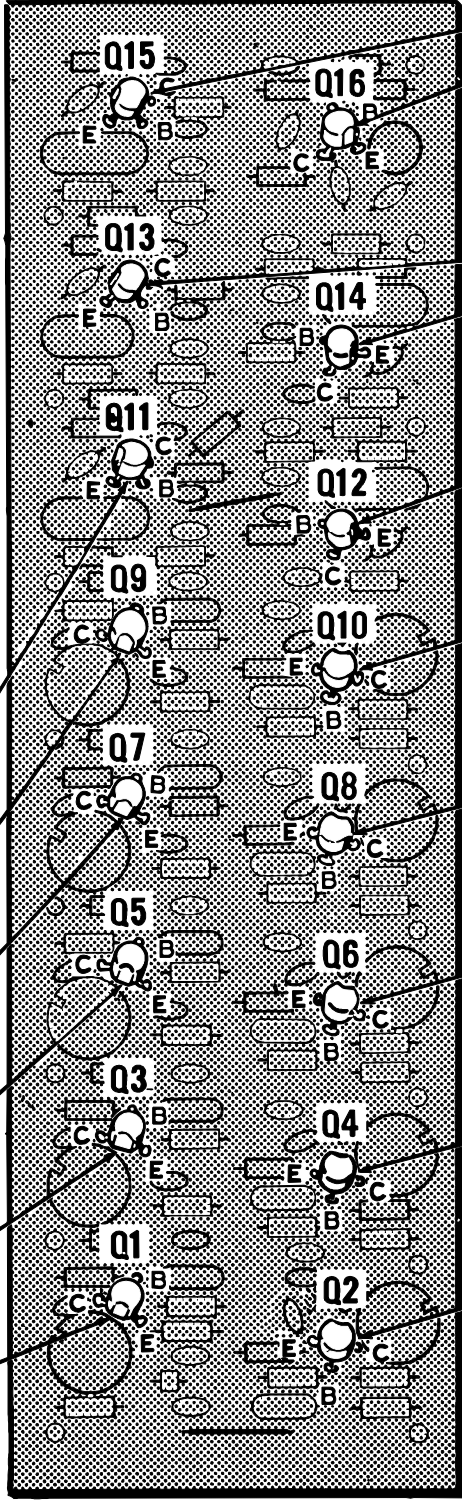

- 2N3692 transistor at Q15.
 - 2N3692 transistor at Q16.
 - 2N3692 transistor at Q13.
 - 2N3692 transistor at Q14.
 - 2N3692 transistor at Q12.
 - 2N3692 transistor at Q10.
 - 2N3692 transistor at Q8.
 - 2N3692 transistor at Q6.
 - 2N3692 transistor at Q4.
 - Position the 40245 transistor (#417-133) as shown and cut off the "S" lead. Then insert the E, B, and C leads in their proper holes in the circuit board and solder the leads to the foil.
-

PICTORIAL 7

PROCEED TO PICTORIAL 8.

START



NOTE: Solder the leads as each part is installed. Do not cut off the excess lead length unless directed to do so in a step. Do not bend the pins on the large crystals.

() 3,080 MHz large crystal (#404-332). Do not bend leads.

NOTE: The crystal to be installed in the next step may be marked 3,579 MHz or 3579,545 kHz.

() 3,579 MHz large crystal (#404-238) at location marked 3,58. Cut off the excess lead length.

() 4,080 MHz large crystal (#404-333). Do not bend leads.

() 39,750 MHz small crystal (#404-334). Cut off the excess lead lengths.

NOTE: When you install the oscillator coils, be sure the notch in the coil is positioned as shown on the Pictorial. Do not cut off any of the coil leads.

() Oscillator coil #40-479 (red).

() 42,170 MHz small crystal (#404-336). Cut off the excess lead lengths.

() Oscillator coil #40-479 (red).

() 42,750 MHz small crystal (#404-344). Cut off the excess lead lengths.

() Oscillator coil #40-479 (red).

() 45,750 MHz small crystal (#404-339). Cut off the excess lead lengths.

() Oscillator coil #40-479 (red).

() 67,250 MHz small crystal (#404-341). Cut off the excess lead lengths.

() Oscillator coil #40-478 (brown).

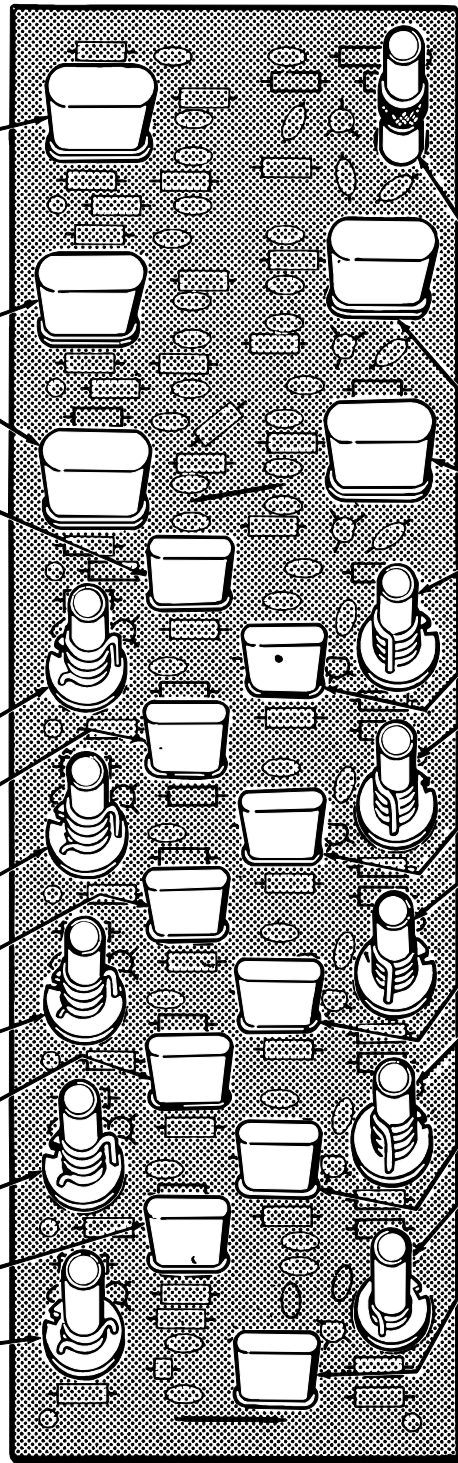

CONTINUE



NOTE: Do not bend the pins on the large crystals.

() Oscillator coil #40-820.

NOTE: The crystal to be installed in the next step may be marked 4.5 MHz or 4500 kHz.

() 4.5 MHz large crystal (#404-4).

() 10,7 MHz large crystal (#404-39). Do not bend leads.

() Oscillator coil #40-479 (red).

() 41,250 MHz small crystal (#404-335). Cut off the excess lead lengths.

() Oscillator coil #40-479 (red).

() 42,500 MHz small crystal (#404-337). Cut off the excess lead lengths.

() Oscillator coil #40-479 (red).

() 45,000 MHz small crystal (#404-338). Cut off the excess lead lengths.

() Oscillator coil #40-479 (red).

() 47,250 MHz small crystal (#404-340). Cut off the excess lead lengths.

() Oscillator coil #40-478 (brown).

() 96,625 MHz small crystal (#404-342). Cut off the excess lead lengths.

() Be sure all connections are properly soldered and that there are no solder bridges between the foils.

Set the oscillator circuit board aside. It will be used later.

PROCEED TO PICTORIAL 9.

PICTORIAL 8

START

() Position the sweep circuit board (#85-233-1) as shown in the Pictorial.

() 2N3393 transistor (#417-118) at Q27. Refer to Detail 9A.

() .6800 Ω (blue-gray-red).

NOTE: In the next two steps, bend one lead of each resistor as shown and mount the resistors in an upright position on the circuit board.

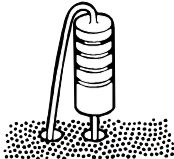

() 22 kΩ (red-red-orange).

() 47 kΩ (yellow-violet-orange).

() 220 Ω (red-red-brown).

() 2N3692 transistor (#417-108) at Q26. Refer to Detail 9B.

() 470 Ω (yellow-violet-brown).

() 2N3692 transistor (#417-108) at Q25. Refer to Detail 9B.

() Ceramic trimmer (#31-36). Solder the lugs to the foil. **NOTE:** Do not bend the lugs.

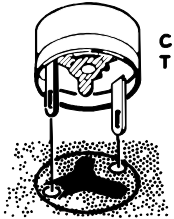

CERAMIC TRIMMER

() Solder the leads to the foil and cut off the excess lead lengths.

Insert the E, C, and B leads of the transistor into the corresponding E, C, and B holes in the circuit board. Position the transistor 1/4" above the circuit board.

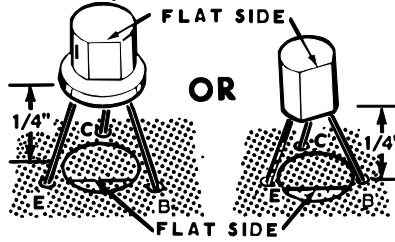

Detail 9A

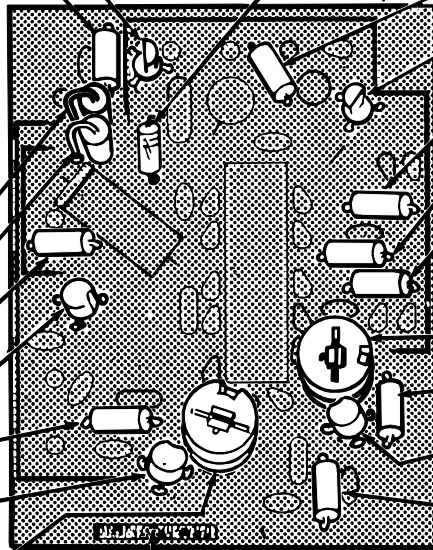

PART NUMBER

Insert the E, C, and B leads of the transistor into the corresponding E, C, and B holes in the circuit board. Position the transistor 1/4" above the circuit board.

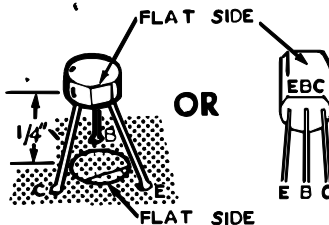

Detail 9B

PICTORIAL 9

CONTINUE



() Crystal diode (#56-26). Be sure you position the cathode end as shown on the circuit board.

NOTE: DIODES MAY BE SUPPLIED IN ANY OF THE FOLLOWING SHAPES. THE CATHODE END OF THE DIODE IS MARKED WITH A BAND OR BANDS. ALWAYS POSITION THIS END AS SHOWN IN THE PICTORIAL.



BAND OR BANDS

() 22 kΩ (red-red-orange).

() 2N3416 transistor (#417-94) at Q23. Refer to Detail 9A.

() 75 Ω (violet-green-black).

() 680 Ω (blue-gray-brown).

() 75 Ω (violet-green-black).

() Solder the leads to the foil and cut off the excess lead lengths.

() Ceramic trimmer.

() 22 kΩ (red-red-orange).

() 2N3692 transistor (#417-108) at Q24. Refer to Detail 9B.

() 270 Ω (red-violet-brown).

() Solder the leads to the foil and cut off the excess lead lengths.

PROCEED TO PICTORIAL 10.



START



NOTE: Do not solder the leads until directed to do so in a step. When you mount an electrolytic capacitor, be sure you insert the positive (+) lead in the positive (+) hole in the circuit board.

- () 25 μ F electrolytic. Bend the negative (-) lead as shown, then mount the capacitor upright on the circuit board.

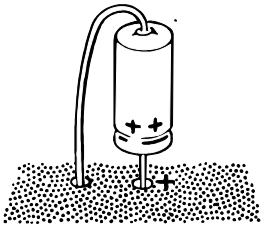

- () .01 μ F disc.

- () .1 μ F Mylar.

- () 3300 pF (#29-8). Position the colored end as shown.

NOTE: In the next two steps, cut each wire to the proper length and remove 1/4" of insulation from each end. Solder each wire as it is installed.

- () 1-7/8" yellow wire between holes U and U.

- () 4-1/4" yellow wire between holes P and P.

- () 470 pF disc.

- () .005 μ F disc.

- () 680 pF resin.

- () 115 pF resin.

- () 200 pF disc.

- () Solder the leads to the foil and cut off the excess lead lengths.

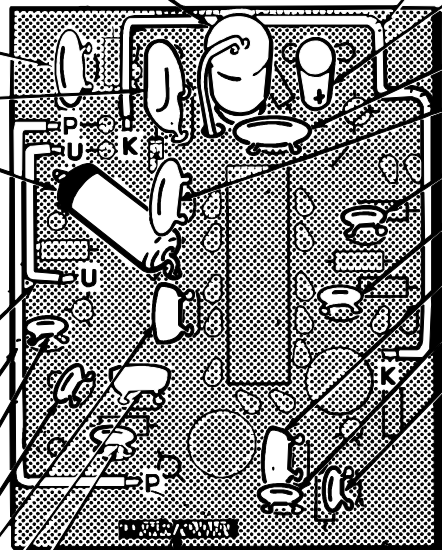

PART NUMBER

CONTINUE



- () 6" yellow wire between holes K and K. Solder both ends of this wire.

- () 10 μ F electrolytic. Position the positive (+) lead as shown.

- () .01 μ F disc.

- () .01 μ F disc.

- () 18 pF disc.

- () .003 μ F disc.

- () 130 pF resin.

- () .005 μ F disc.

- () 200 pF disc.

- () Solder the leads to the foil and cut off the excess lead lengths.

PROCEED TO PAGE 20.

PICTORIAL 10

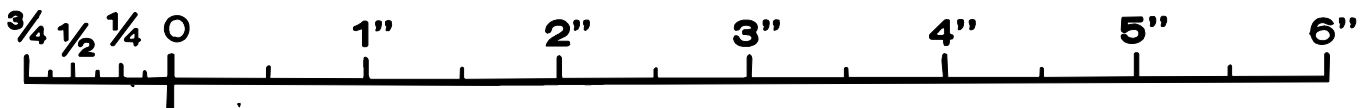

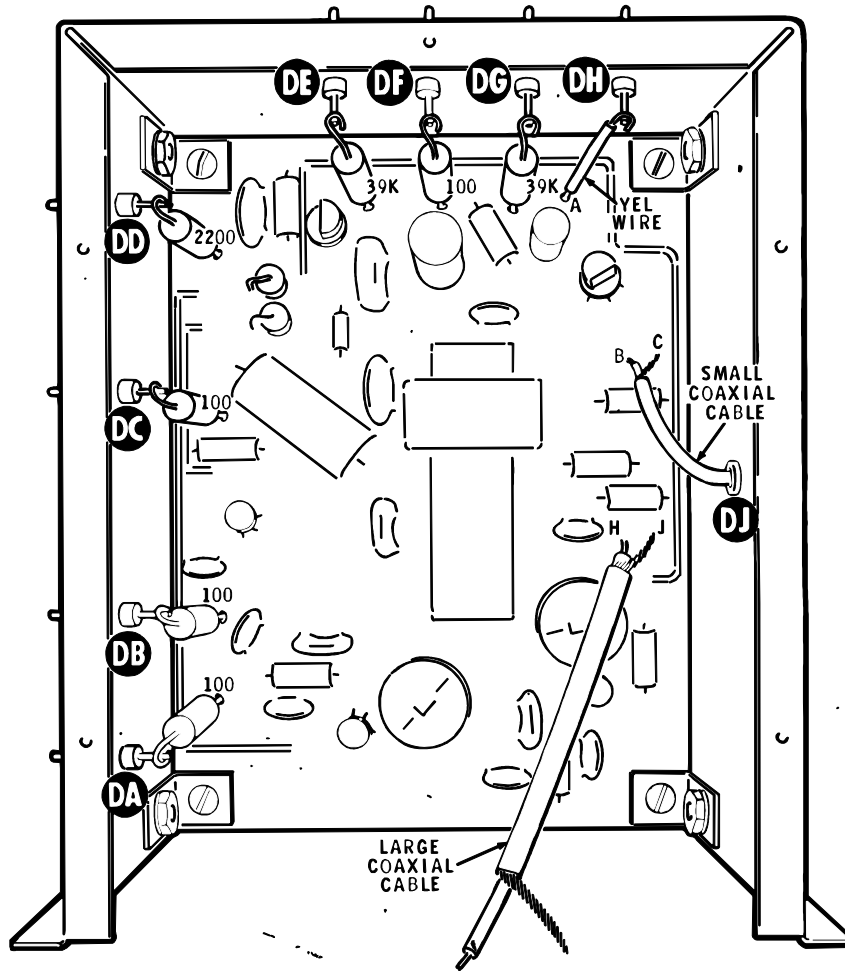

PICTORIAL 12



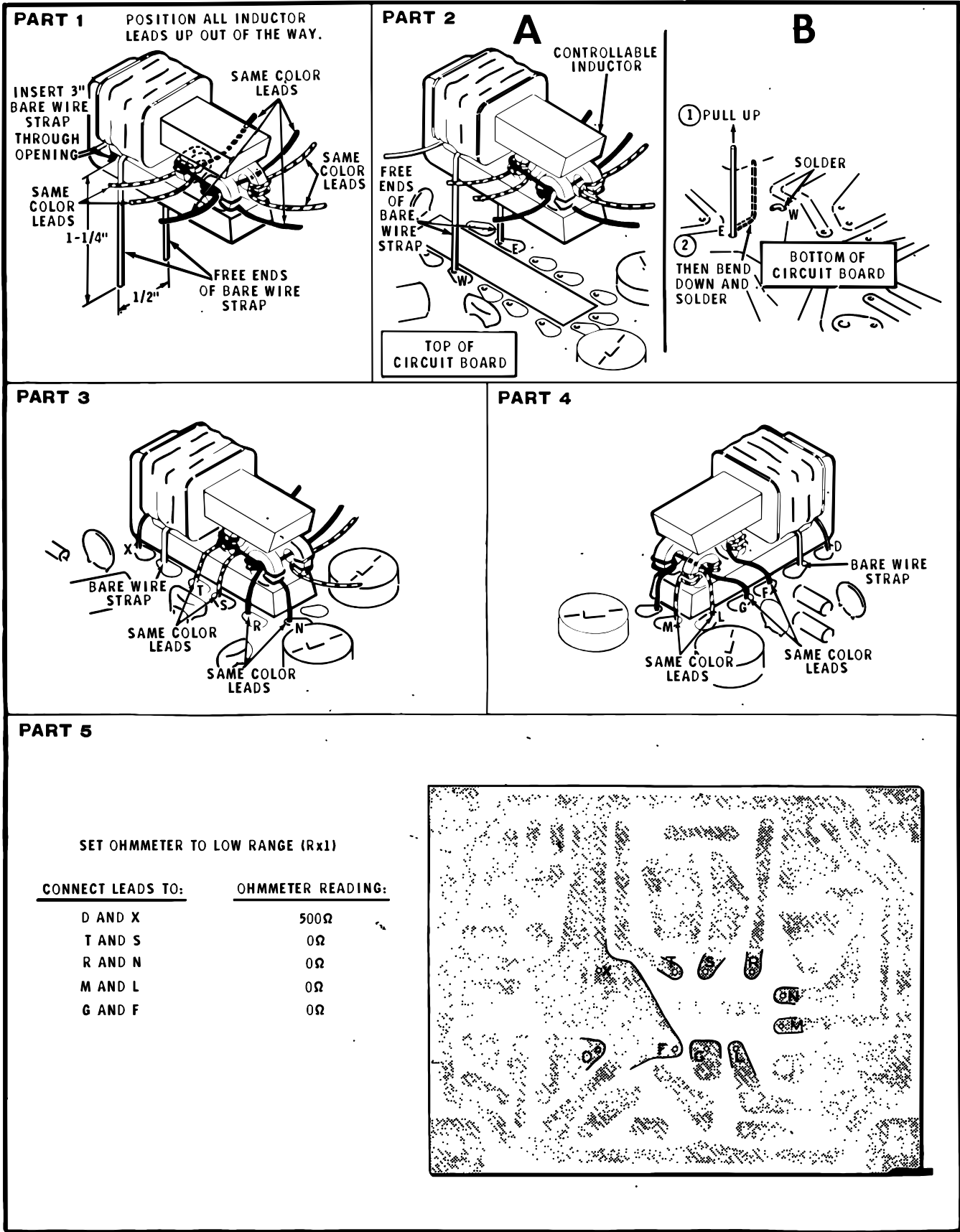

PICTORIAL 11

Refer to Pictorial 11 (fold-out from this page) for the following steps.

NOTE: Be sure you do not drop the controllable inductor and damage its powdered iron core.

- (.) Remove the insulation from a 3" yellow wire.
- () Refer to Detail 11A and form the 3" bare wire as shown. It will be used as a hold-down strap.

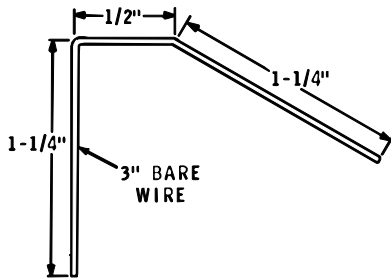

Detail 11A

- () Insert the angled end of the wire through the opening between the large coil and the inductor core. Then bend the angled end down so the wire is shaped in an inverted U. See Part 1 of Pictorial 11.
- () Refer to Part 2A of Pictorial 11 and carefully bend the ten leads of the inductor up out of the way and insert the ends of the wire U through holes W and E in the sweep circuit board. Line up the inductor core with the outline on the circuit board.

CAUTION: Hold the inductor in place while you perform the following steps.

- () Turn the circuit board over. Then referring to Part 2B of Pictorial 11, bend over the end of the wire coming from hole W and solder it to the foil. Cut off the excess length of this wire.
- () Again refer to Part 2B of the Pictorial and use long-nose pliers to pull up on the wire coming from hole E; at the same time, bend it over as shown.
- () Now solder this wire to the foil at E. Do not cut off the excess wire until directed to do so.
- () Refer to Part 3 of the Pictorial and, using small long-nose pliers, carefully insert the leads coming from the left side of the inductor into the indicated holes in the circuit board.
- () Refer to Part 4 of the Pictorial and carefully insert the leads coming from the right side of the inductor into the indicated holes in the circuit board.
- () Turn the circuit board over and lightly pull each lead through its hole as far as it will go.
- () Now solder each lead to the foil and cut off the excess lead lengths.
- () Be sure the inductor is firmly mounted on the circuit board. To tighten the inductor, refer to Part 2B of Pictorial 11 and melt the solder at E. At the same time, pull slightly on the wire coming from this hole; then resolder the wire and cut off the excess length.
- () Refer to Part 5 of the Pictorial and, using an ohmmeter set to the low ohms position (R x 1), check the resistance between the points indicated in the chart. The reading should be as shown.

SWEEP SHIELD

Refer to Pictorial 12 for the following steps.

NOTE: When hardware is called for, only the screw size is given. For instance, if 4-40 x 1/4" hardware is called for, it means that a 4-40 x 1/4" screw, one or more #4 lockwashers, and a 4-40 nut should be used for each mounting hole. The Detail referred to in the step shows the proper position and number of lockwashers.

The Heath Company has provided a plastic nut starter with this kit. Use this nut starter to pick up and start nuts on screws. Refer to Page 3 of the Kit Builders Guide for further information.

- () Refer to Detail 12A and mount angle brackets on the sweep circuit board at the four locations shown in the Pictorial. Use 4-40 x 1/4" hardware as shown in the Detail.

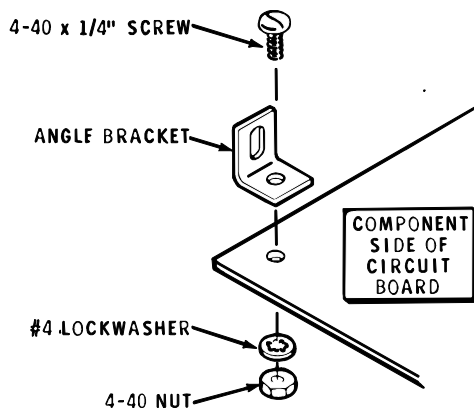

Detail 12A

NOTE: Be sure you use the 9-1/2' length of the large (75 Ω) coaxial cable in the next step.

- () Refer to Detail 12B and prepare a 2-3/4" length of large coaxial cable.

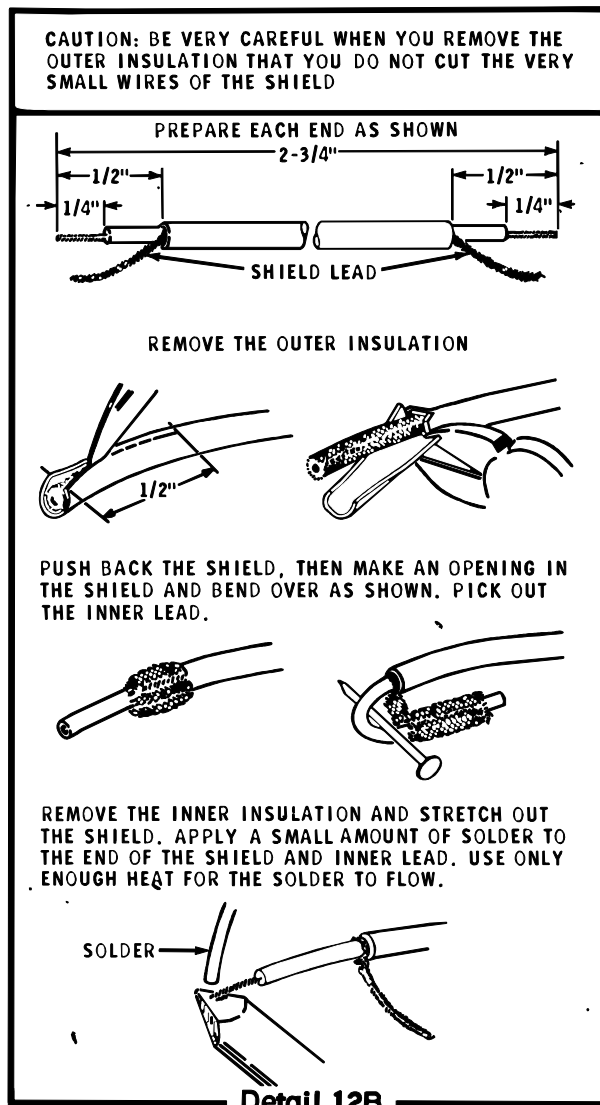

CAUTION: When you perform the next step, be sure you do not damage the insulation on the yellow wire as you solder the shield lead in hole J.

- () At one end of the cable, insert the inner lead into hole H and the shield lead into hole J. Solder the leads to the foil and cut off the excess lead lengths. The free end will be connected later.

Lay the sweep circuit board aside and perform the following steps.

Refer to Detail 12C for the following steps.

- () Locate the sweep shield (#206-383) and position it as shown in Pictorial 12.
- () Refer to Detail 12C and install nylon feedthrough in holes DA, DB, DC, DD, DE, DF, DG, and DH. Install each feedthrough from the outside of the shield and press the tapered end firmly into its hole. Then squeeze the tapered end slightly flat.
- () Install a rubber grommet (#75-53) in hole DJ.

NOTE: Do not use the 6-32 x 1/4" black screws or phillips head screws until directed to do so in a step.

- () Refer to Detail 12D and insert the sweep circuit board into the open end of the sweep shield; then secure the circuit board to the shield with 6-32 x 1/4" hardware at the four locations shown.

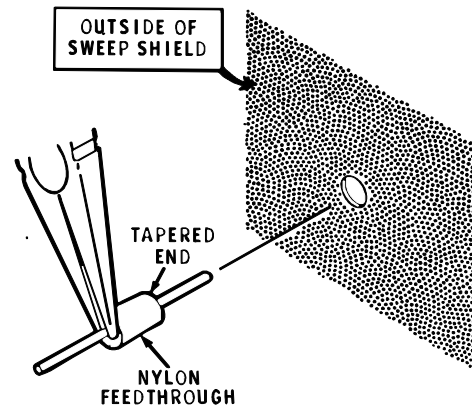

Detail 12C

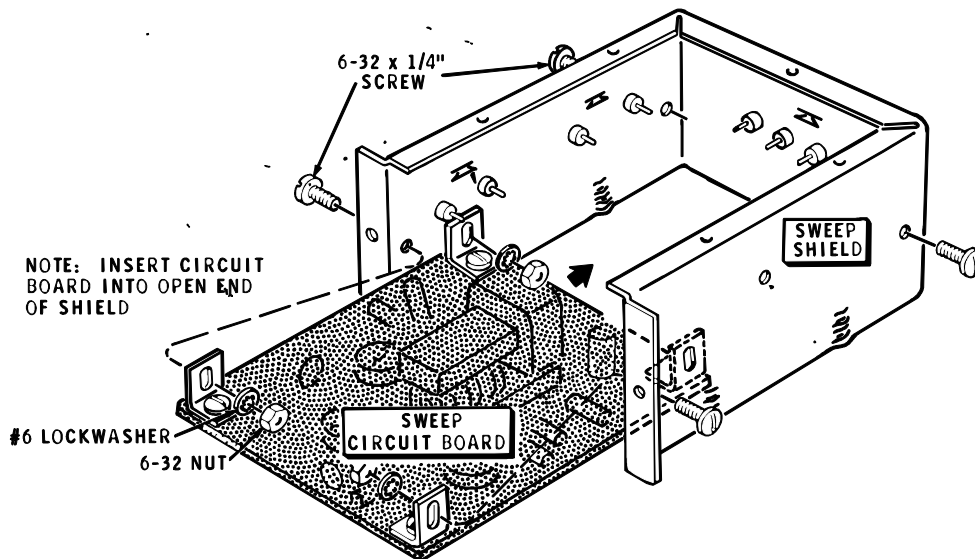

Detail 12D

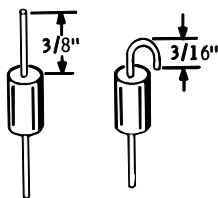

Detail 12E

Refer to Detail 12E and Pictorial 12 (fold-out from Page 20) for the following steps.

NOTE: Insert the straight lead of each resistor in the proper hole in the circuit board and solder the looped lead to the pin of the specified feedthrough.

- () Refer to Detail 12E and prepare one lead on each of four 100 Ω (brown-black-brown) resistors as shown.
- () Insert the straight lead of one of these resistors in the circuit board hole marked 100 (NS) and place the looped lead over the pin of feedthrough DA (S-1).
- ✓ In a like manner, install the remaining three prepared resistors between the circuit board holes marked 100 (NS) and feedthrough DB (S-1), DC (S-1), and DF (S-1).
- () Refer to Detail 12E and prepare two 39 k Ω (orange-white-orange) resistors.
- () Install these two prepared resistors between the circuit board holes marked 39 k (NS) and feedthroughs DE (S-1) and DG (S-1).
- () Again refer to Detail 12E and prepare a 2200 Ω (red-red-red) resistor.
- ✓ Install this prepared resistor between the circuit board hole marked 2200 (NS) and feedthrough DD (S-1).
- () Remove 1/4" of insulation from each end of a 1" yellow wire.
- ✓ Wrap one end of this wire around the pin of feedthrough DH (S-1), and insert the other end of the wire in circuit board hole A (NS).

CAUTION: BE VERY CAREFUL WHEN YOU REMOVE THE OUTER INSULATION THAT YOU DO NOT CUT THE VERY SMALL WIRES OF THE SHIELD LEAD.

PREPARE EACH END AS SHOWN

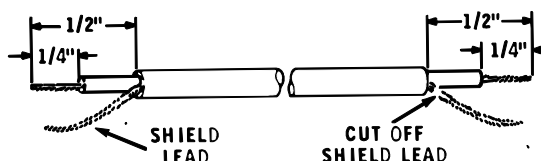

PEEL OFF THE FOIL AND STRAIGHTEN OUT THE SMALL WIRES OF THE SHIELD LEAD.



REMOVE THE INNER INSULATION AND TWIST TOGETHER THE SMALL WIRES OF THE SHIELD LEAD. APPLY A SMALL AMOUNT OF SOLDER TO THE END OF THE SHIELD LEAD AND THE INNER LEAD.

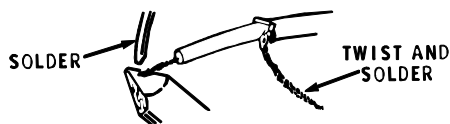

Detail 12F

- ✓ Turn the sweep assembly over; then solder the free ends of the seven resistors and the yellow wire to the circuit board foil and cut off the excess lead lengths.
- () Refer to Detail 12F and prepare a 10-1/2" small coaxial cable.

CAUTION: In the next step, be sure you do not damage the insulation on the yellow wire when you solder the shield lead into hole C.

- () At the end of the cable with the shield lead, insert the inner lead in circuit board hole B and the shield lead in hole C. Solder the leads to the foil and cut off the excess lead lengths.
- () Insert the other end of the coaxial cable through grommet DJ for connection later.



Refer to Pictorial 13 for the following steps.

- () Position the sweep assembly as shown in the Pictorial.

Connect disc capacitors from the feedthroughs to the solder tabs on the sweep shield. Wrap the capacitor lead around the feedthrough pin as close to the nylon insulation as possible. NOTE: Do not use the .005 μF 1.4 kV disc capacitors.

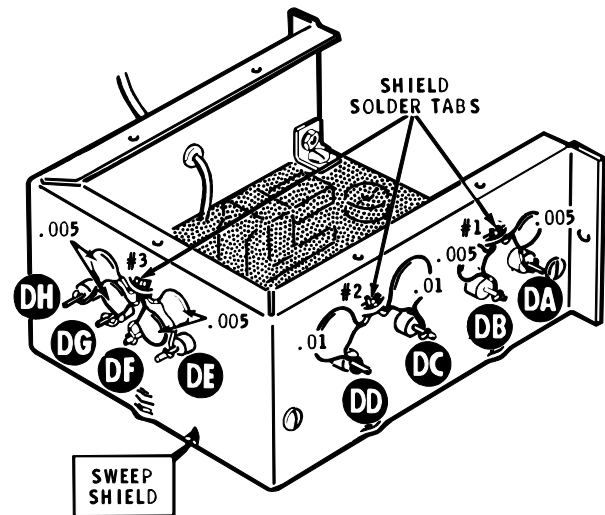

PICTORIAL 13

Disc Capacitor:	From:	To Shield Solder Tab:
() .005 μF	DA (NS)	#1 (NS)
() .005 μF	DB (NS)	#1 (S-2)
() .01 μF	DC (NS)	#2 (NS)
() .01 μF	DD (NS)	#2 (S-2)
() .005 μF	DE (NS)	#3 (NS)
() .005 μF	DF (NS)	#3 (NS)
() .005 μF	DG (NS)	#3 (NS)
() .005 μF	DH (NS)	#3 (S-4)

CHASSIS

Refer to Pictorial 14 for the following steps.

NOTE: When mounting the circuit boards, do not tighten the hardware until you are sure the holes in the circuit boards line up with the holes in the chassis.

- () Position the chassis as shown in the Pictorial.
- () Mount the amplifier (small) circuit board (#85-192-2) on the chassis so the four upright capacitors are nearest the center of the chassis. Use a #8 long lug on the bottom of the chassis at CN. Secure the circuit board with 4-40 x 1/4" hardware.

- () Mount the oscillator circuit board (#85-193-3) on the chassis with 4-40 x 1/4" hardware in the unlabeled holes.
- () Mount a 3-lug terminal strip (#431-3) at CA with 4-40 x 1/4" hardware as shown.
- () Mount a no-lug terminal strip on the bottom of the chassis at CB. Use 4-40 x 1/4" hardware.
- () Mount #8 long lugs on the bottom of the chassis at CN, CD, and CE with 4-40 x 1/4" hardware. Position each lug pointing away from the circuit board.
- () Mount a #6 solder lug and a #8 long lug at CC with 4-40 x 1/4" hardware. Point the #6 lug toward the side and the #8 lug away from the circuit board.



NOTE: The sweep assembly will be secured to the chassis with only two #6 sheet metal screws at this time. Be sure you insert these sheet metal screws in the two indicated holes in the chassis and the sweep shield.

from the bottom of the chassis, secure the sweep assembly with #6 x 3/8" sheet metal screws at locations CK and CL.

() Place the sweep assembly on the top of the chassis as shown in the Pictorial. Then,

(✓) Lay the chassis aside. It will be called for later.

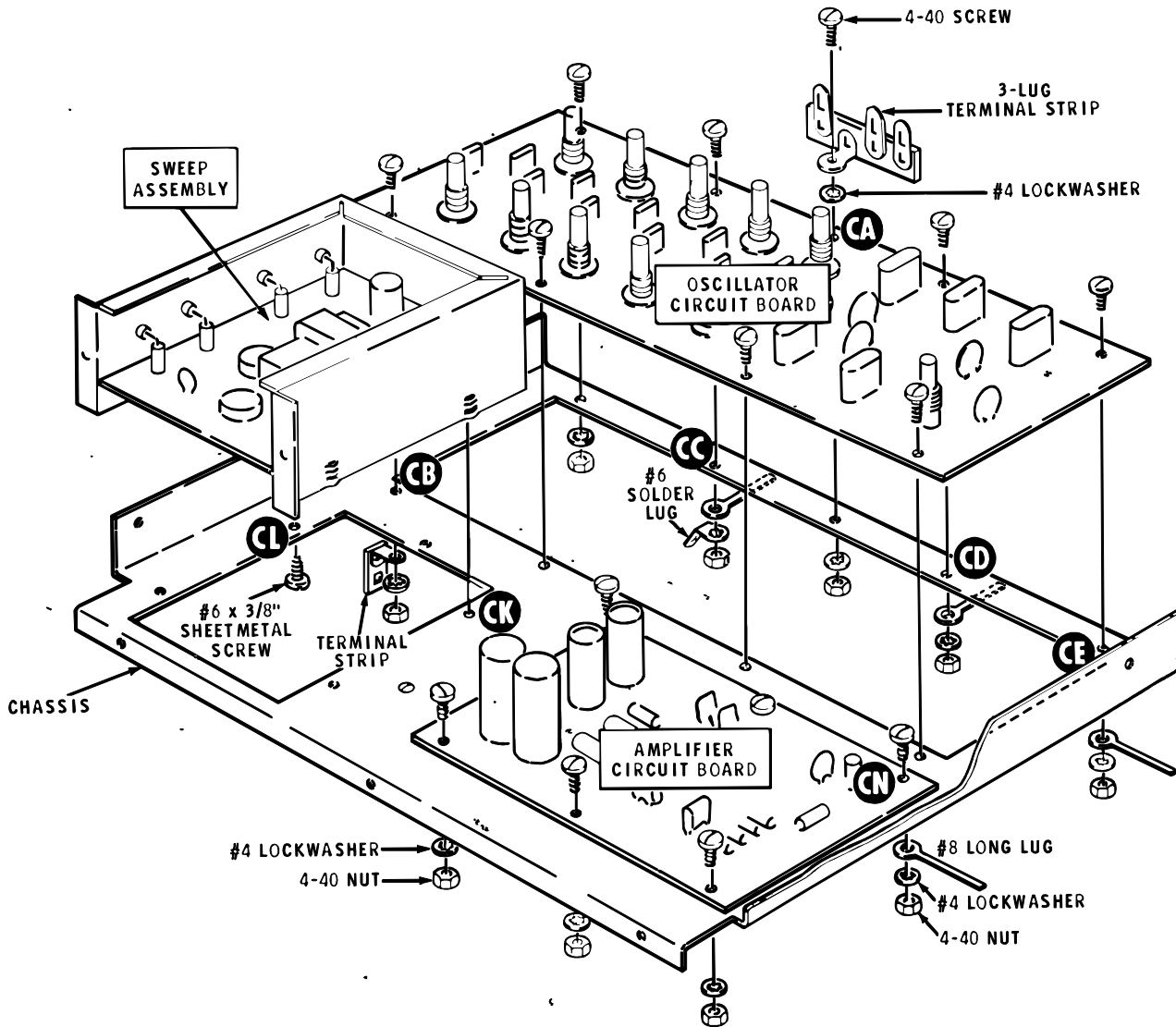

PICTORIAL 14

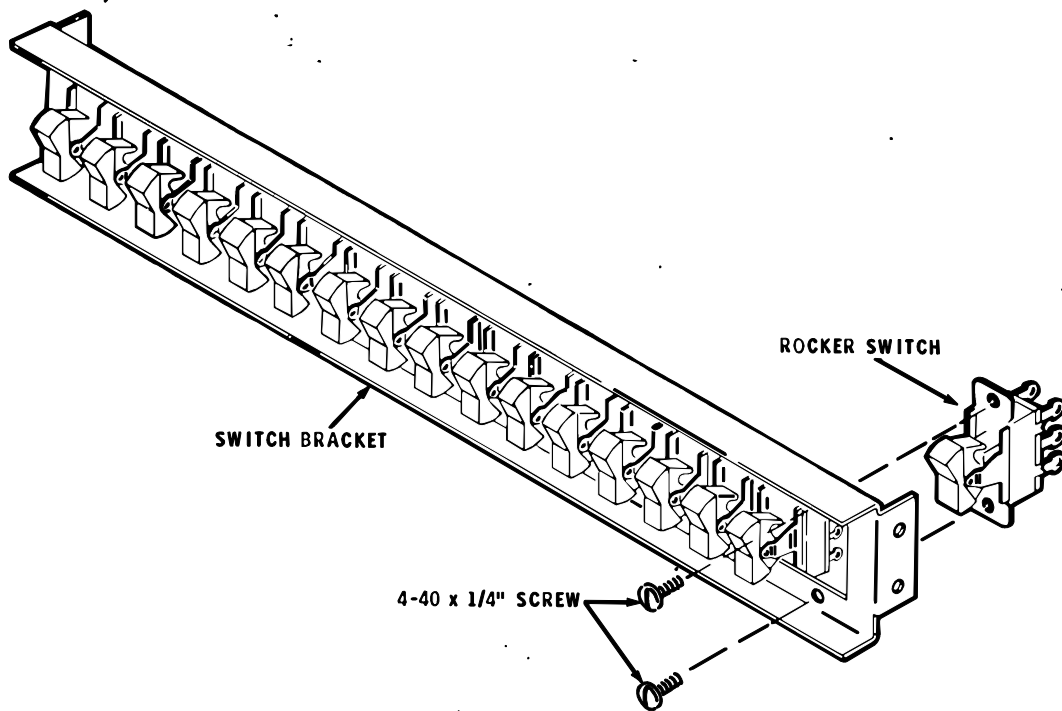

PICTORIAL 15

FRONT-PANEL

NOTE: The plastic nut starter can be used to hold the 4-40 screws while they are started into the rocker switch frame.

- () Refer to Pictorial 15 and mount 17 rocker switches to the switch bracket (#204-811) with 4-40 screws. Be sure you mount the switches on the proper side of the switch bracket.
- () Lay the switch assembly aside until it is called for later.

Refer to Pictorial 16 for the following steps.

- () Mount binding post bases at AF, AG, AH, AT, and AU. Refer to Detail 16A and use two insulator bushings, a #6 solder lug and two 6-32 nuts for each base. Position the holes through each base horizontally and each solder lug as shown in Pictorial 16.

- () Turn red binding post caps (#100-16-18) onto binding post bases AF, AG, and AU and black binding post caps (#100-16-2) onto binding post bases AH and AT.

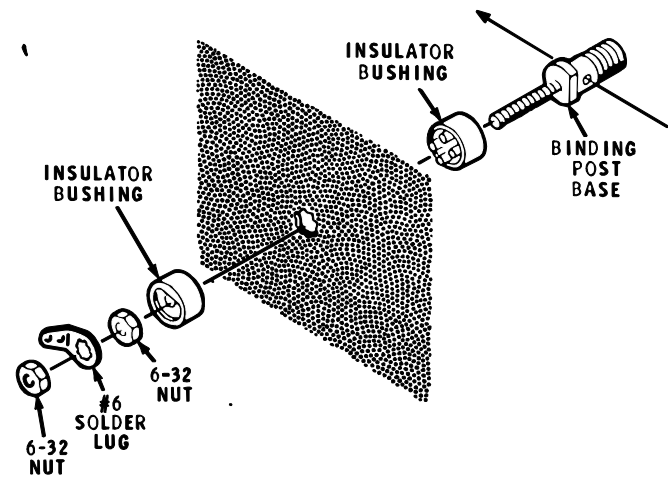

Detail 16A

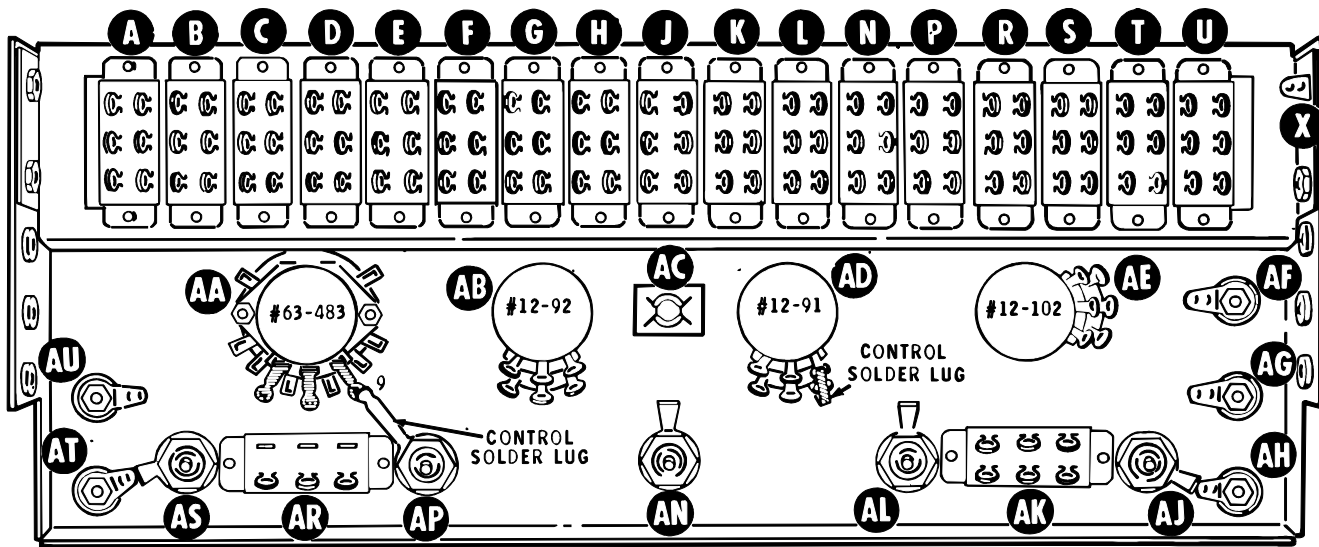

PICTORIAL 16

CAUTION: In the following step, the screwdriver head should be larger than the opening in the end of the binding post base, but small enough to go through the hole in the binding post cap.

() Refer to Detail 16B and tap the handle of a phillips head screwdriver with a hammer

to enlarge the open end of each binding post so the caps cannot be removed.

() Refer to Detail 16C and mount a wafer switch with control (#63-483) at AA. Position the switch so the "open" area of the wafer is upward as shown in the Pictorial.

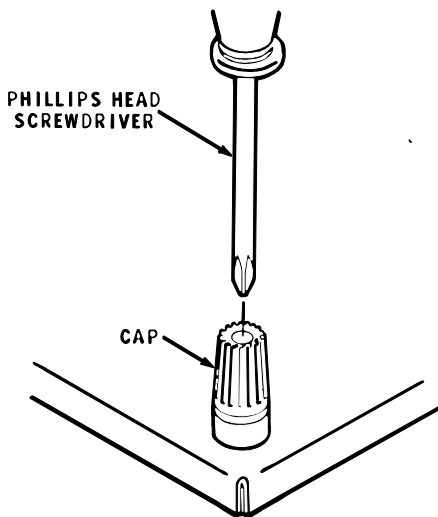

Detail 16B

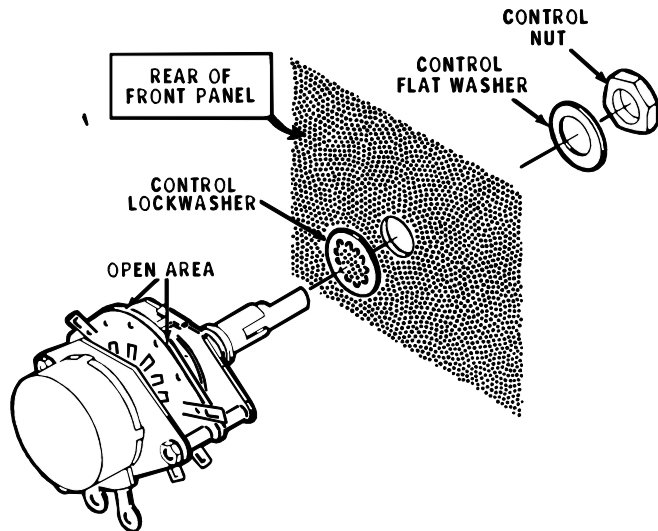

Detail 16C

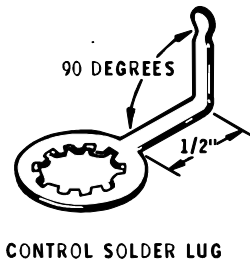

CONTROL SOLDER LUG

Detail 16D

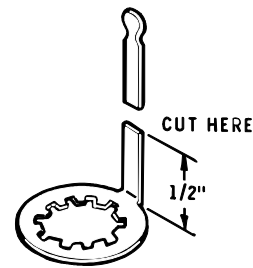

CONTROL SOLDER LUG

Detail 16F

- () Refer to Detail 16D and prepare a control solder lug as shown.
- () Mount a 10 k Ω /1 M Ω dual concentric control (#12-91) at AD. Use the prepared control solder lug, a control flat washer, and control nut. Position the bent portion of the solder lug in line with lugs 3 and 6 of the control and tighten the nut. See Detail 16E.

- () Refer to Detail 16F and prepare five control solder lugs as shown.
- () Refer to Detail 16G and mount coaxial connectors (#432-59) at AS, AN, AL, and AJ. Use one of the prepared solder lugs in place of the lockwashers supplied with the connectors. Position each solder lug as shown in the Pictorial. The remaining prepared solder lug will be used later.
- () Mount a coaxial connector at AP. Use a regular control solder lug in place of the lockwasher supplied with the connector. Form and position the control solder lug so its end is against lug 9 of control AA; then tighten the nut.

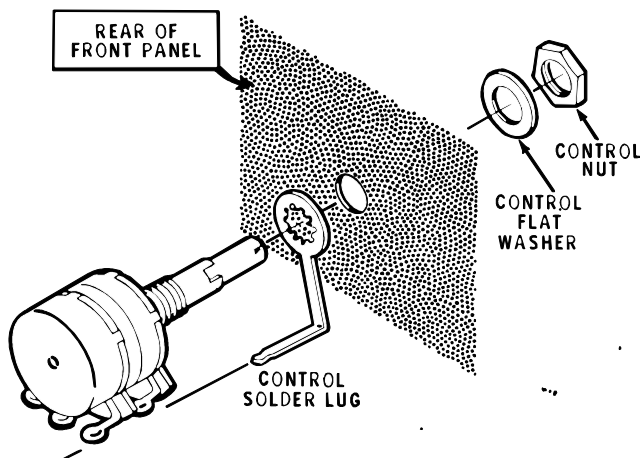

Detail 16E

- () Mount a 10 k Ω /5 k Ω dual control (#12-92) at AB. Use a control lockwasher, flat washer, and nut. Position the control as shown in the Pictorial.
- () In a similar manner, mount a 20 k Ω /20 k Ω dual control (#12-102) at AE. Position the control lugs as shown in the Pictorial.

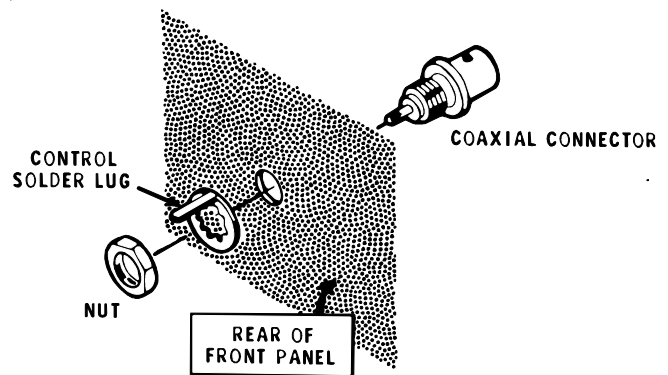

Detail 16G

- () Refer to Detail 16H and mount a red lens at AC with a speednut (#252-9). Position the slot as shown and press the speednut firmly against the front panel.

NOTE: In the next step, be sure the wide area of the bracket is positioned as shown in the Detail when you mount the switch assembly to the front panel. Do not use the 6-32 x 1/4" phillips screws until directed to do so in a step.

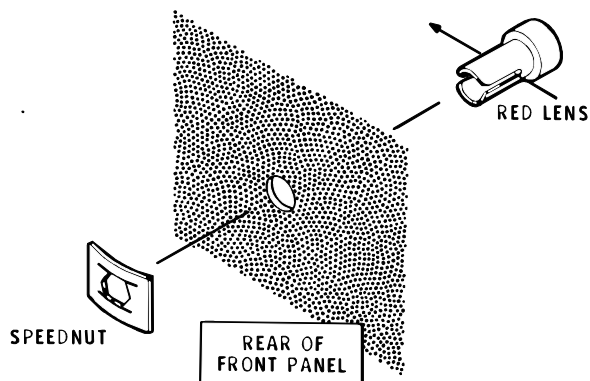

Detail 16H

- () Refer to Detail 16J (fold-out from this page) and mount the switch assembly to the front panel. Use 6-32 x 1/4" hardware with a #6 solder lug instead of a lockwasher at location X.

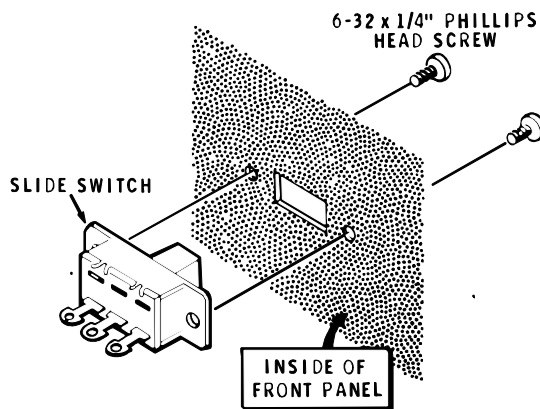

Detail 16K

NOTE: Each rocker switch must operate freely after the switch assembly is secured. If any switch binds, mark it and remove the switch assembly. Loosen the two switch mounting screws and reposition the switch slightly; then tighten the mounting screws and remount the switch assembly.

- () Refer to Detail 16K and mount an SPDT slide switch (#60-4) at AR with 6-32 x 1/4" phillips head screws. Position the switch as shown and do not overtighten the screws.

- () In a similar manner, mount a DPDT slide switch (#60-2) at AK.

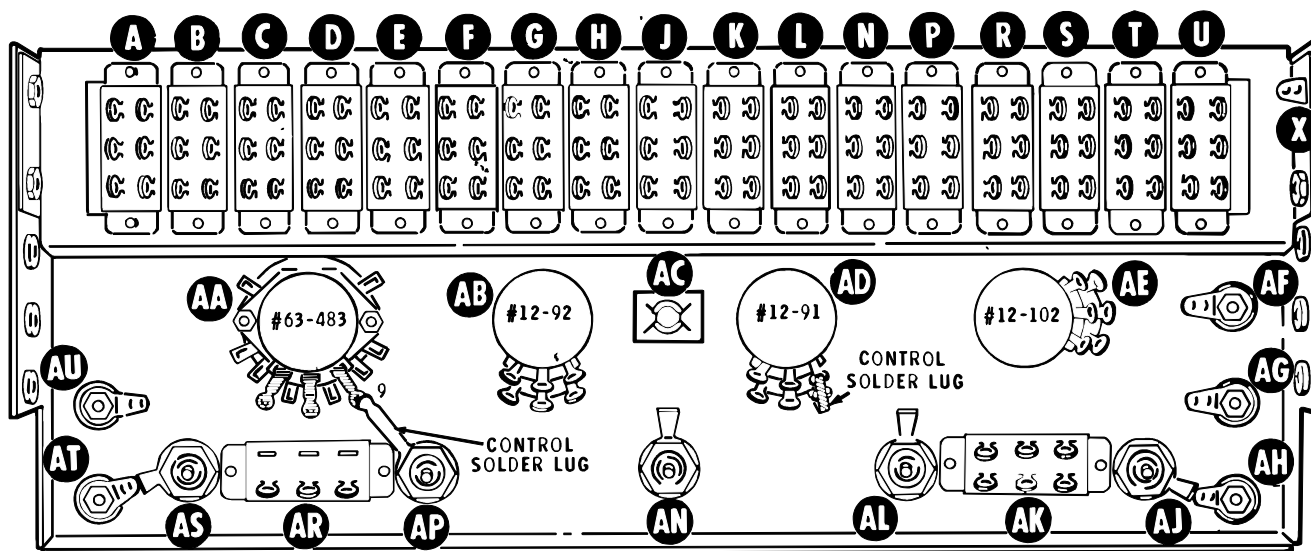
 PICTORIAL 16
(Repeat)

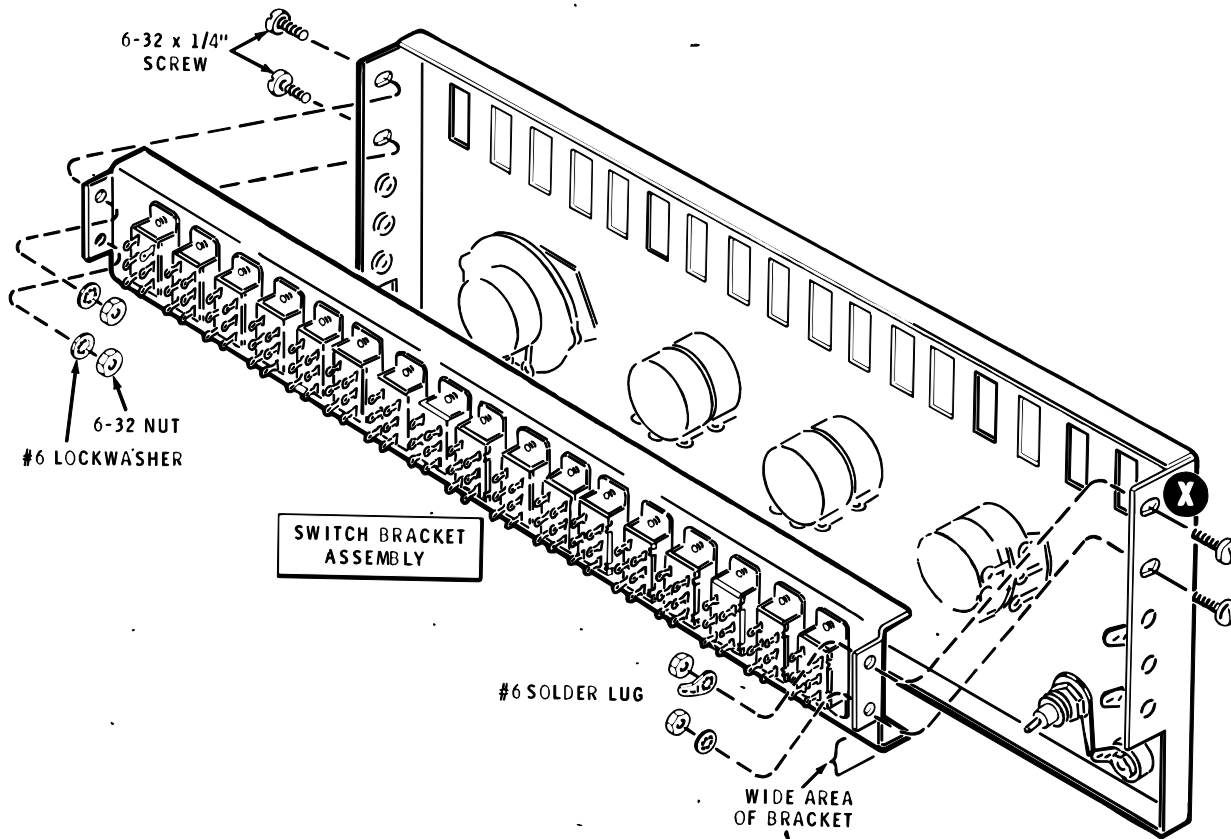

Detail 16J



Initial Wiring - Front Panel

Refer to Detail 17A for the following steps.

- () Locate the 8-wire cable and cut it to 15-1/2".
- () Prepare the 8-wire cable according to the dimensions indicated in the Detail. Cut off the black and the yellow wires at each end of the outer insulation because these cable wires will not be used. Remove 1/4" of insulation from each end of the remaining leads.

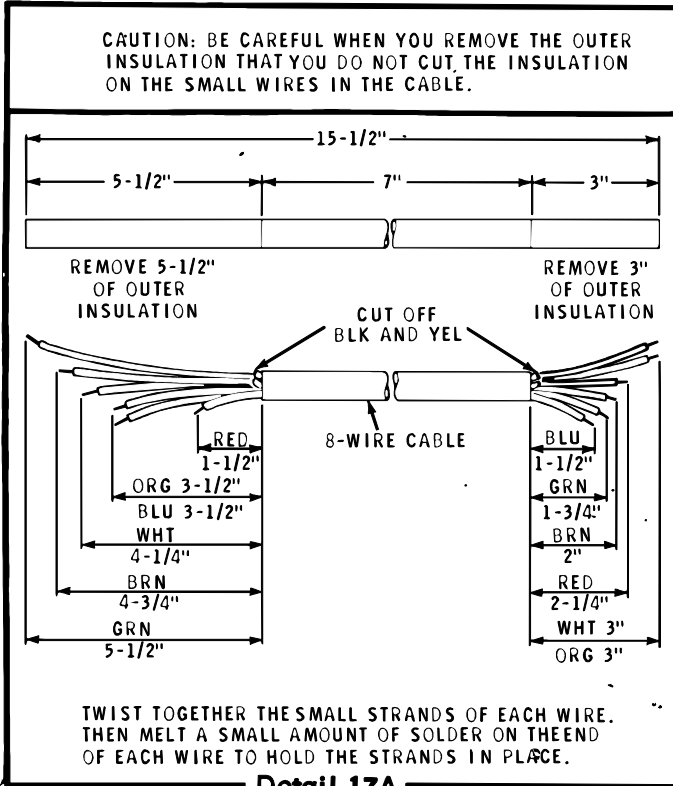

Refer to Detail 17B and at the end of the prepared cable with the short green wire, connect the wires as follows:

- () Brown to lug 3 of switch AA (S-1).
- () Green to lug 4 of switch AA (S-1).
- () Blue to lug 5 of switch AA (S-1).
- () Red to lug 1 of switch AB (NS).
- () Orange to lug 2 of control AB (S-1).
- () White to lug 5 of control AB (S-1).

Position this cable down against the panel between the switches.

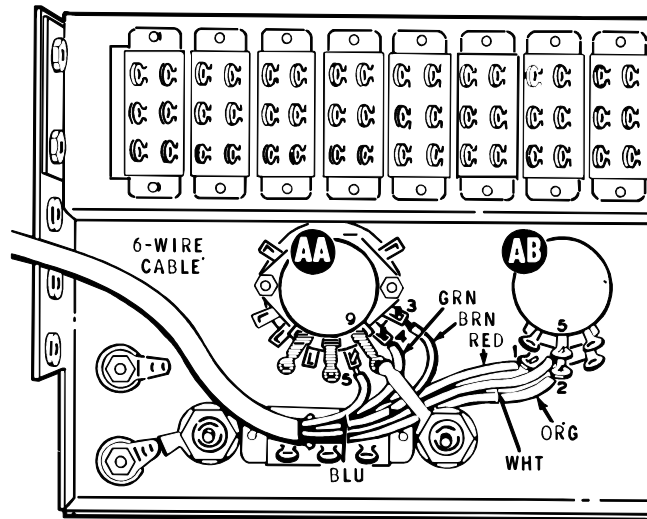

Detail 17B

The wires at the other end of the cable will be connected later.

Refer to Pictorial 17 for the following steps.

- (✓) Solder lug 9 of control AA to the control solder lug coming from AP (S-1).
- (✓) Connect a 2-1/2" red wire from lug 2 of switch AA (S-1) to lug 1 of control AB (S-2).
- (✓) Connect a 4" yellow wire from lug 7 of switch AA (NS) to lug 4 of control AB (S-1).
- (✓) Connect a 2200 Ω (red-red-red) resistor from lug 1 (S-1) to lug 7 (S-2) of switch AA.
- (✓) Connect one lead of a 6800 Ω (blue-gray-red) resistor to lug 6 of switch AA (S-1).
- (✓) Connect the other lead of the resistor to the solder lug at AT (NS). Position the resistor away from lugs of switch AR.
- (✓) Connect one lead of a .1 μ F Mylar capacitor to AU (NS). Wrap the other lead of the capacitor around the solder lug AT (NS) and the control solder lug at AS (NS).
- (✓) Connect one lead of a 68 k Ω (blue-gray-orange) resistor to AU (NS). Wrap the other lead of the resistor around the solder lug at AT and the control solder lug at AS (S-4). NOTE: Be sure both leads and both solder lugs are soldered together.

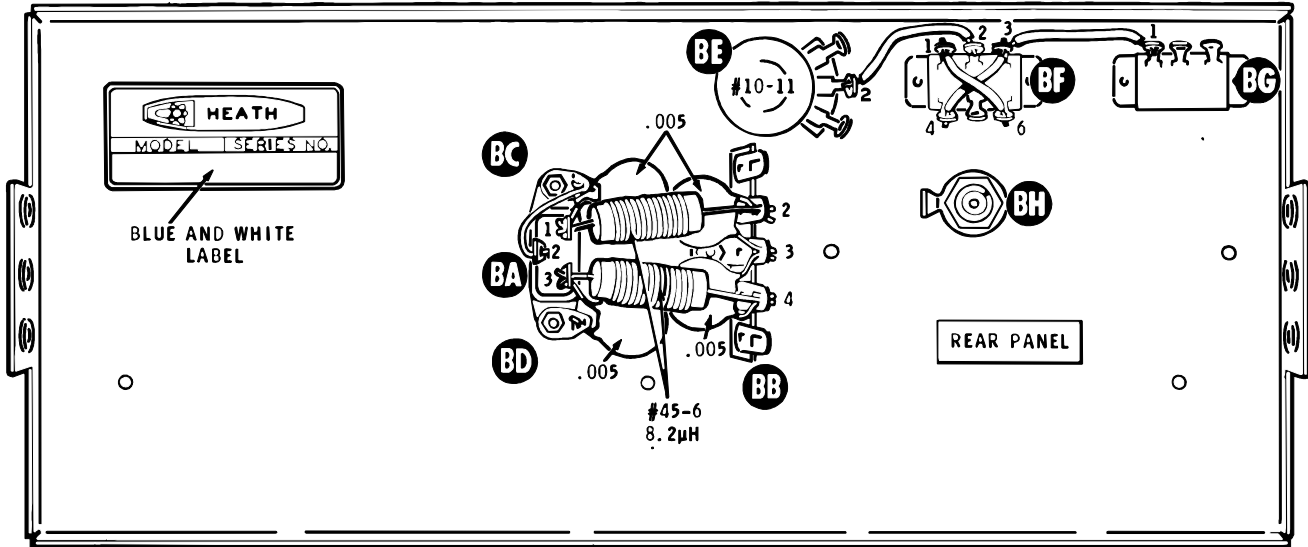

PICTORIAL 18

(✓) Connect one lead of a .01 μ F disc capacitor to lug 10 of control AA (S-1). Connect the other lead of the capacitor to the center lug of connector AP (S-1). Position capacitor leads away from lugs of switch AR.

NOTE: Where a wire passes through a connection and then goes to another point, as in the next step, it will count as two wires in the solder instructions (S-2), one entering and one leaving the connection.

(✓) Connect one lead of a 1000 Ω (brown-black-red) resistor to lug 3 of control AB (S-1). Wrap the other lead of the resistor around the solder lug at AN (S-2) and connect it to lug 6 of control AB (S-1).

(✓) Use a small amount of solder and solder lug 3 (S-1) and lug 6 (S-1) of control AD to the control solder lug at control AD.

(✓) Connect one lead of a .005 μ F disc capacitor to lug 2 of control AD (NS). Wrap the other lead around the control solder lug between lug 3 and lug 6 of control AD (S-1).

(✓) Remove the insulation from a 1-1/2" yellow wire.

(✓) Connect the 1-1/2" bare wire from lug 4 of control AD (S-1) to the center lug of connector AN (S-1).

() Remove 3/4" insulation from one end of a 3" red and a 6" black wire.

(✓) Pass the bare end of the black wire through lug 1 (S-2) and connect it to lug 4 (S-1) of control AE.

(✓) Connect the other end of the black wire to solder lug AH (NS).

(✓) Pass the bare end of the red wire through lug 3 (S-2) and connect it to lug 6 (S-1) of control AE.

(✓) Connect the other end of the red wire to lug 2 of switch AK (S-1).

(✓) Connect a 2-1/2" black wire from solder lug AH (NS) to lug 5 of switch AK (S-1).

(✓) Connect a 1" black wire from lug 3 (NS) to lug 4 (S-1) of switch AK.

() Connect a 1" red wire from lug 1 (S-1) to lug 6 (NS) of switch AK.

(✓) Connect one lead of a 220 Ω (red-red-brown) resistor to lug 2 of control AE (S-1). Connect the other lead of this resistor to solder lug AG (S-1).

(✓) Connect one lead of a 220 Ω (red-red-brown) resistor to lug 5 of control AE (S-1). Connect the other lead of this resistor to solder lug AF (S-1).

(✓) Connect one lead of a 100 Ω (brown-black-brown) resistor to the center lug of connector AJ (NS). Wrap the other lead around the solder lug at AJ and through solder lug AH (NS).

(✓) Remove all of the insulation from a 10-1/2" length of black wire.

(✓) Insert this bare wire through lugs 2 (NS) and 5 (NS) of rocker switches A through T, and through lug 2 (NS) of rocker switch U.

NOTE: Where a wire passes through a connection and then goes to another point, as in the next step, it will count as two wires in the solder instructions (S-2), one entering and one leaving the connection.

(✓) Now solder lug 2 (S-2) and lug 5 (S-2) on each rocker switch A through T. Do not solder lug 2 of rocker switch U. NOTE: Cut off the excess lead length of switch A.

(✓) Connect a 220 Ω (red-red-brown) resistor from lug 4 (NS) to lug 5 (S-1) of rocker switch U.

() Connect a 10 k Ω (brown-black-orange) resistor from lug 2 of switch U (S-2) to solder lug X (S-1).

() Prepare a 20" length of each of the following hookup wires:

- Red
- White
- Black

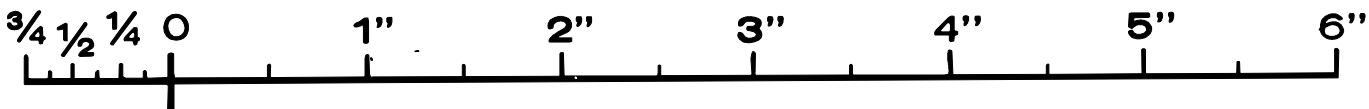

- () Refer to Detail 17C and twist these three together.



Detail 17C

Refer to Detail 17D (fold-out from Page 30) for the following steps.

- () Connect the white wire to lug 3 of switch AR (NS).
- () Connect the black wire to lug 2 of switch AR (NS).
- () Connect the red wire to lug 1 of switch AR (S-1).
- () Prepare a 9-1/2" black and a 9-1/2" white hookup wire and twist them together.
- () At one end of the twisted pair, connect the black wire to lug 2 of switch AR (S-2).
- () At the same end of the twisted pair, connect the white wire to lug 3 of switch AR (S-2).
- () Again refer to Detail 17C and twist together a 13-1/2" black wire and 13-1/2" red wire.
- () At one end of this twisted pair, connect the black wire to lug 3 (S-2) and the red wire to lug 6 (S-2) of switch AK.
- () The other ends of the twisted wires will be connected later.

Lay the front panel aside until it is called for later.

REAR PANEL

Assembly

Refer to Pictorial 18 (fold-out from Page 30) for the following steps. Position all parts as shown in the Pictorial.

- () Locate the rear panel and position it as shown.
- () Refer to Detail 18A and mount an AC connector (#432-76) at BA with #6 solder lugs and 6-32 x 1/4" hardware. Position the lugs as shown.

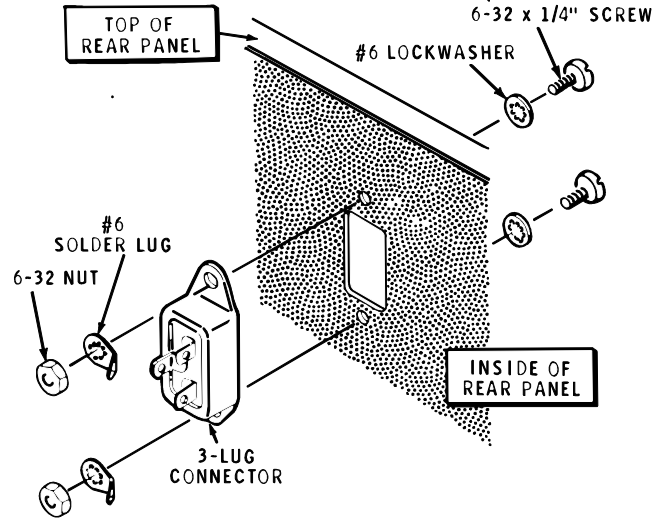

Detail 18A

- () Refer to Detail 18B and mount a 5-lug terminal strip (#431-11) at BB with 6-32 x 1/4" hardware.

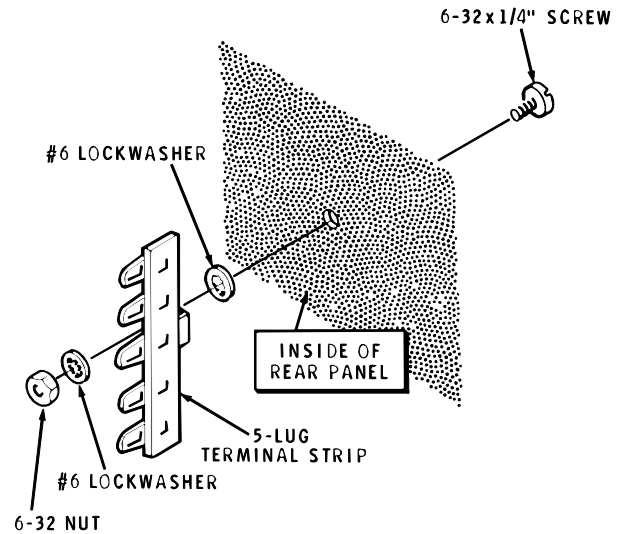

Detail 18B

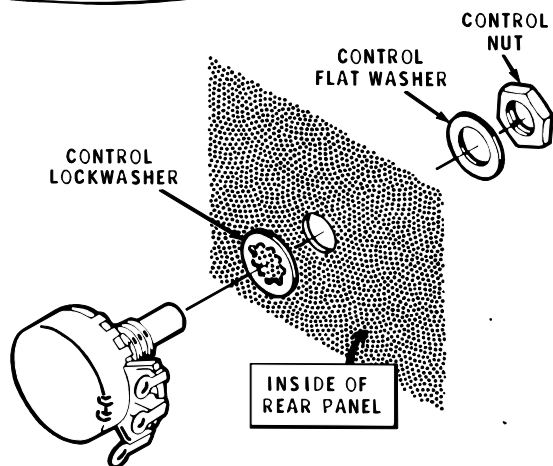

Detail 18C

- () Refer to Detail 18C and mount a 50 k Ω control (#10-11) at BE. Use a control lockwasher, flat washer, and nut.
- () Refer to Detail 18D and mount a DPDT slide switch (#60-2) at BF with 6-32 x 1/4" hardware. Do not overtighten the screws.
- () In a similar manner, mount an SPDT slide switch (#60-4) at BG. Position the switch lugs as shown in the Pictorial.

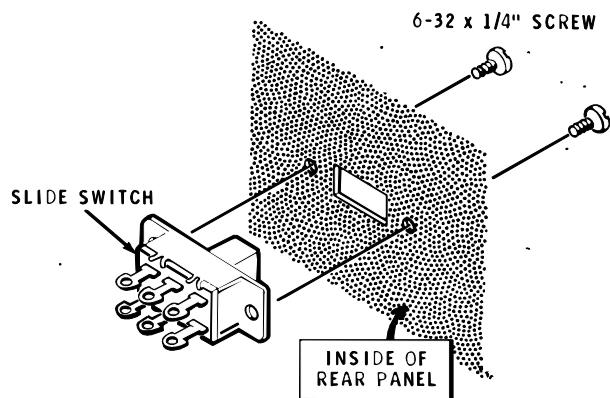

Detail 18D

- () Mount a coaxial connector (#432-59) at BH. Use a previously prepared control solder lug in place of the lockwasher supplied with the connector. Position the solder lug as shown in the Pictorial.
- () Remove the backing paper from the blue and white label. Then press the label onto the inside of the rear panel as shown in Pictorial 18.

NOTE: Be sure you refer to the numbers on this label in any correspondence you may have with the Heath Company regarding this kit. You will then receive complete and up-to-date information in return.

Wiring

NOTE: In the following steps, be sure the leads of the chokes and capacitors do not touch the metal frame of connector BA.

- () Connect a 2" bare wire from lug 2 of connector BA (S-1) to solder lug BC (NS).
- () Connect a .005 μ F 1.4 kV disc capacitor from solder lug BC (S-2) to lug 1 of connector BA (NS).
- () Connect a .005 μ F 1.4 kV disc capacitor from solder lug BD (S-1) to lug 3 of connector BA (NS). Position this capacitor as shown.
- () Connect a .005 μ F 1.4 kV disc capacitor between lug 4 (NS) and lug 3 (NS) of terminal strip BB.
- () Connect a .005 μ F 1.4 kV disc capacitor between lug 2 (NS) and lug 3 (S-2) of terminal strip BB.
- () Connect an 8.2 μ H choke (#45-6) from lug 3 of connector BA (S-2) to lug 4 of terminal strip BB (NS).
- () Connect an 8.2 μ H choke (#45-6) from lug 1 of connector BA (S-2) to lug 2 of terminal strip BB (NS).
- () Connect a 1-1/4" yellow wire between lug 4 (NS) and lug 3 (NS) of switch BF. Press this wire down against the switch and away from the two center lugs of the switch.
- () In a like manner, connect a 1-1/4" yellow wire between lug 1 (NS) and lug 6 (S-1) of switch BF.
- () Connect one end of a 2-1/2" yellow wire to lug 2 of control BE (S-1). Connect the other end of this wire to lug 2 of switch BF (S-1).
- () Connect a 2-1/2" yellow wire from lug 3 of switch BF (S-2) to lug 1 of switch BG (S-1).





CHASSIS FINAL ASSEMBLY

Refer to Pictorial 19 for the following steps.

- () Mount the rear panel assembly to the chassis with 6-32 x 1/4" hardware at the three locations in the rear panel. NOTE: Be sure to use two lockwashers at each location, one under the screw and one under the nut.
- () Secure the rear panel to the sweep shield with #6 sheet metal screws and #6 lockwashers.

NOTE: When you mount the siderails, the narrow spaced holes in each siderail must be toward the rear panel. Do not tighten the hardware until directed to do so in a step.

- () Mount a siderail on the right end of the chassis and the rear panel with a 6-32 x 7/16" spacer stud and 6-32 x 1/4" hardware at the four locations shown toward the rear of the chassis.
- () Mount a 7-lug terminal strip (#431-35) on the inside of the chassis. Use 6-32 x 1/2" hardware at CF and CH.

- () Now tighten all of the hardware that secures the siderail to the rear panel and the chassis.
- () In a similar manner, mount the remaining siderail on the left end of the chassis. Use a 6-32 x 7/16" spacer stud and 6-32 x 1/4" hardware at the five locations shown.
- () Install a 6-32 x 1/2" screw, a #6 lockwasher and a 6-32 nut at location CJ.
- () Now tighten all of the hardware that secures this siderail to the rear panel and the chassis.

Refer to Pictorial 20 for the following steps.

- () Place the bezel over the front panel; then position the panel and bezel between the free ends of the siderails on the chassis.
- () Secure the panel and bezel to each siderail with one 6-32 x 7/16" spacer stud and 6-32 x 1/2" hardware at each end of the panel. Be sure the bezel is positioned firmly against the front panel.



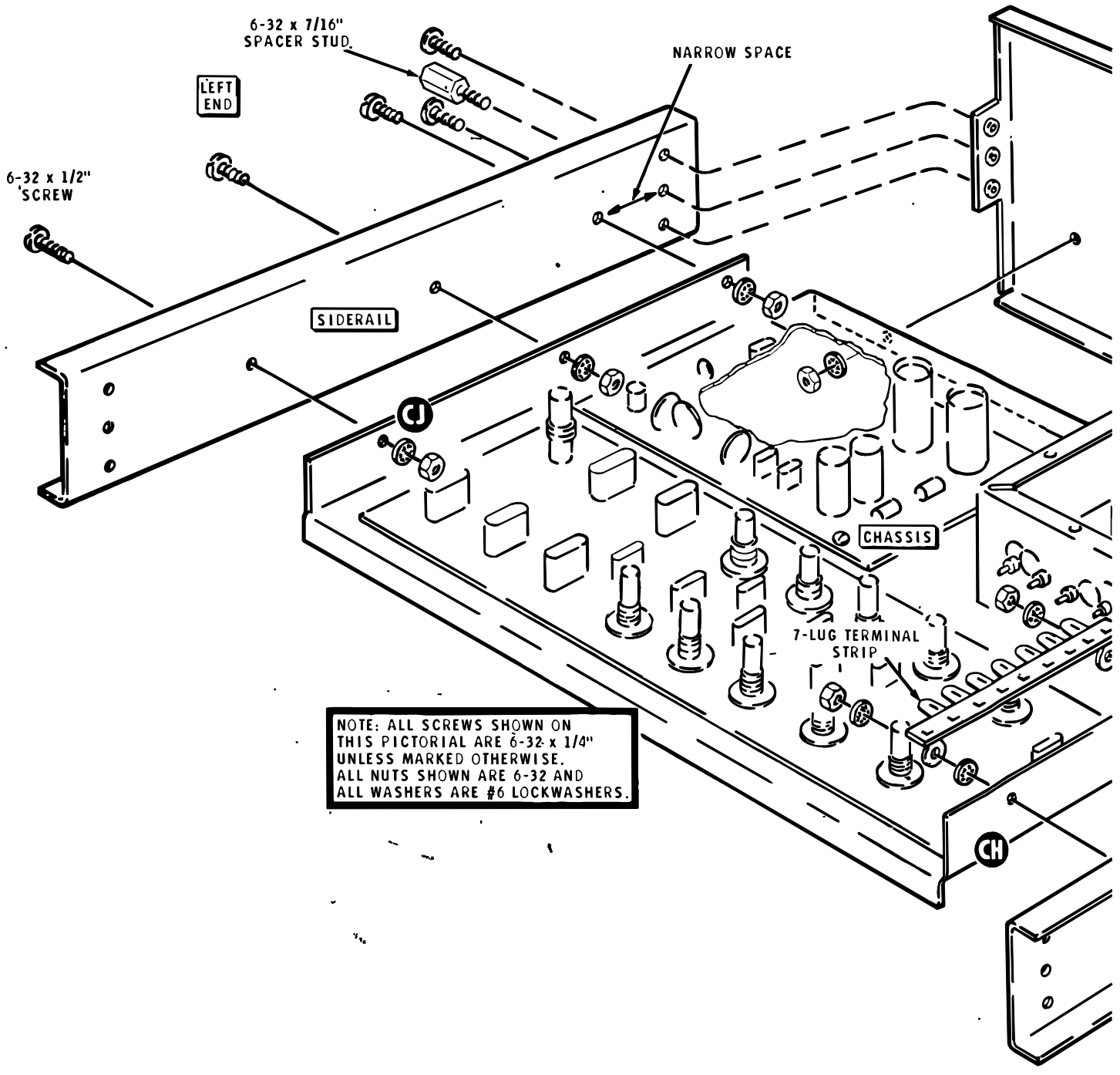

PICTORIAL 19

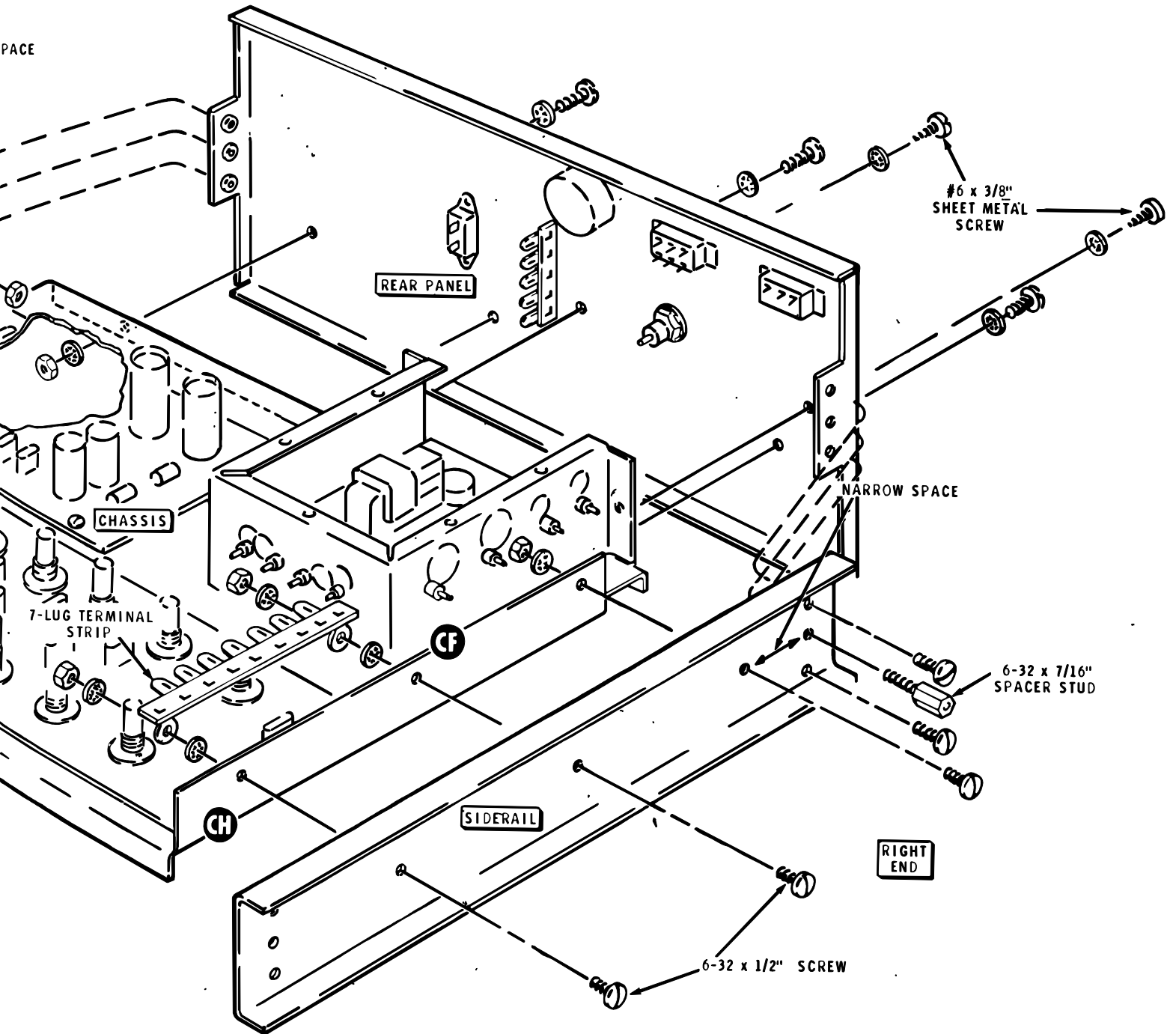

PICTORIAL 19

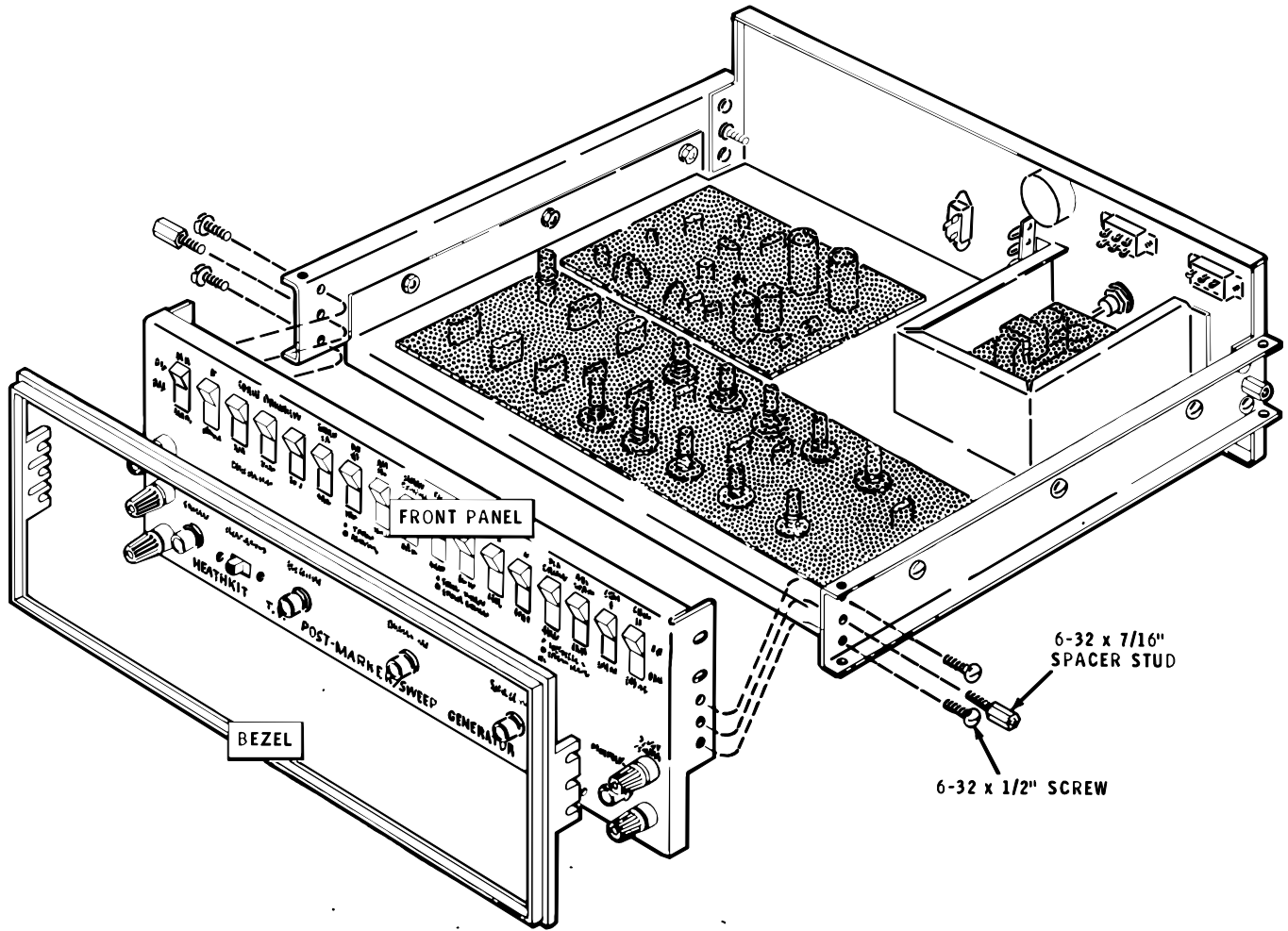

PICTORIAL 20

INSTALLING KNOBS

NOTE: The front panel knobs for this kit use bushings that must be pressed into the knobs before they are mounted on the shafts of the controls.

Refer to Pictorial 21 for the following steps.

In the following steps, the pointer on each knob will be lined up with a specific mark on the front panel. Whenever you remove any knob, be sure you replace it on the control shaft from which it was removed.

CAUTION: Look very carefully at each concentric bushing (#455-52) before you perform the following steps. Note that the bushing has a round hole at one end and a "keyed hole" at the other end. Be sure you place the bushing on the outer shafts of the controls so the round hole is toward the panel.

- () Refer to Part 1 of Detail 21A and place a concentric bushing (round hole toward the panel) on the outer shafts of the controls at AA, AB, AD and AE. Then turn all three control shafts to their full counterclockwise positions.
- () Line up the pointer of a concentric knob (#462-247) with the OFF mark on the panel at location AA. Then press the knob part way onto the bushing.
- () Now carefully remove both the bushing and the knob. Do not allow the knob to come off of the bushing.
- () Refer to Part 2 of Detail 21A and place the knob and bushing on a table or other firm surface. Use a nut driver or a large screwdriver and drive the bushing into the knob. Place a soft cloth under the knob to prevent it from being marred.

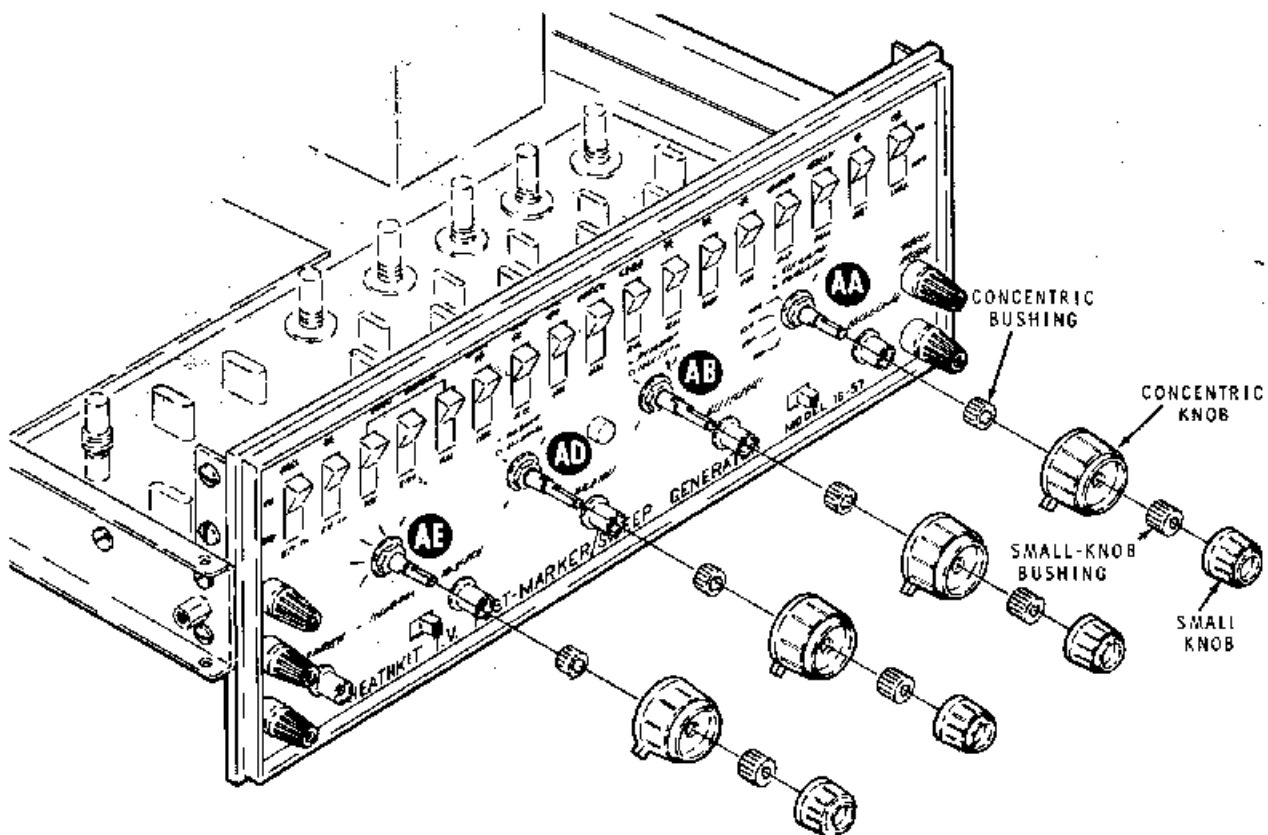

PICTORIAL 21

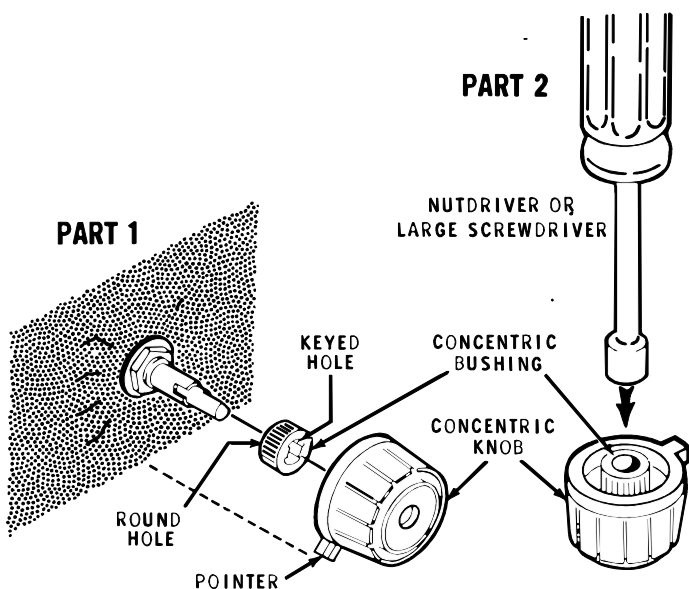

Detail 21A

- () Line up the pointer mark of a small knob (#462-276) with the full counterclockwise mark on the panel at AA. Then press the knob part way onto the bushing.
- () Now carefully remove both the bushing and the knob. Do not allow the knob to come off of the bushing.
- () Refer to Part 2 of Detail 21B and place the knob and bushing on a table or other firm surface. Use a nut driver and drive the bushing into the knob as far as it will go.

- () Repeat the above four steps and drive a concentric bushing into each of the three remaining concentric knobs. The pointers of the knobs should line up with the mark at the 7 o'clock position on the panel when the knobs are turned to their full counterclockwise position.

In the following steps, the pointer mark on each small knob should be lined up with the full counterclockwise mark on the panel (locations AA, AB, AD and AE). Whenever you remove one of these knobs, be sure you replace it at the location from which it was removed.

- () Refer to Part 1 of Detail 21B and push a small-knob bushing (#455-51) onto each of the small control shafts at AA, AB, AD and AE. The slotted opening should be positioned away from the front panel. Then turn the control shafts to their full counterclockwise positions.

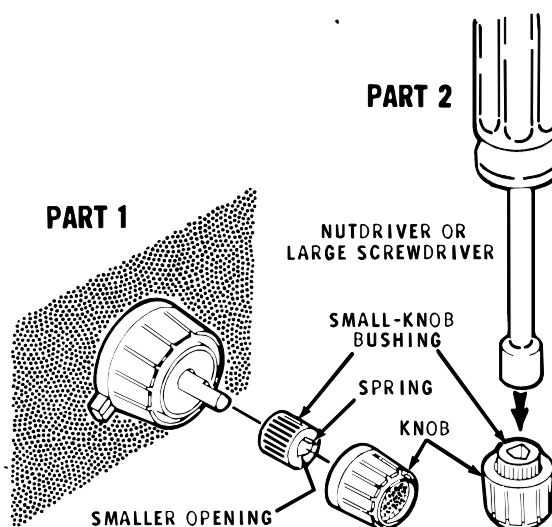

Detail 21B

- () Repeat the above three steps and drive small-knob bushings into the remaining small knobs. The pointer mark of each small knob must line up with the specified mark on the panel.
- () Mount the small black knob on the shaft of the Phase Adjust control on the rear panel.

CHASSIS WIRING

CHASSIS BOTTOM

NOTE: Whenever possible, position the insulated wires and cables down against the chassis. Form and position each wire or cable to make the kit as neat as possible when it is completed.

Refer to Pictorial 22 for the following steps.

- () Solder the oscillator circuit board to the chassis at the two locations indicated.
- () Solder the amplifier circuit board to the chassis at the four locations indicated.
- () Refer to Detail 22A and prepare the following lengths of small coaxial cable.

17-1/2"	19-1/2"
12"	8-1/2"
12"	17-1/2"
8-1/2"	16-1/2"

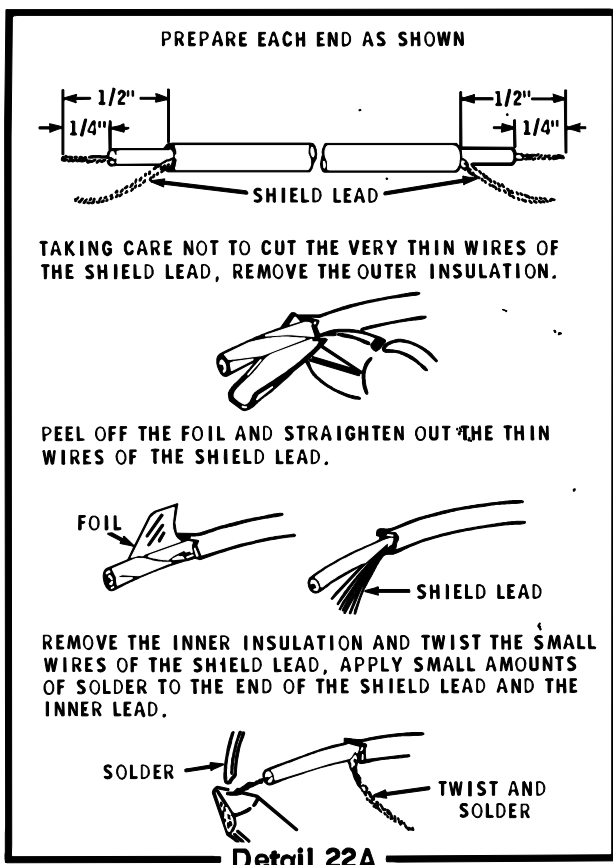

NOTE: After you have connected a coaxial cable in the following steps, be sure the shield lead does not touch any adjacent lug or connection.

- (✓) At one end of a 17-1/2" coaxial cable, connect the inner lead to lug 1 of control AD (S-1). Wrap the shield lead around the control solder lug at lug 3 of control AD (NS).
- (✓) At one end of a 12" coaxial cable, connect the inner lead to lug 2 of control AD (S-2). Wrap the shield lead around the control solder lug at lug 3 of control AD (S-2).
- (✓) At one end of a 12" coaxial cable, connect the inner lead to lug 5 of control AD (S-1). Wrap the shield lead around the control solder lug at lug 6 of control AD (S-1).
- (✓) Route the free ends of these three coaxial cables toward the top of the chassis. They will be connected later.
- (✓) At one end of an 8-1/2" coaxial cable, connect the inner lead to lug 1 (S-2) and the shield lead to lug 2 of connector AJ. Now solder the four leads and two solder lugs together.
- (✓) At the free end of this cable, connect the inner lead to hole FF (S-1) and the shield lead to hole EE (S-1) in the amplifier circuit board.
- (✓) At one end of a 19-1/2" coaxial cable, connect the inner lead to lug 1 (S-1) and the shield lead to lug 2 (S-1) of connector AL. The free end of this cable, will be connected later.
- () At one end of an 8-1/2" coaxial cable, connect the inner lead to lug 11 of control AA (S-1). Wrap the shield lead around the control solder lug connected to lug 9 of control AA (S-1).
- (✓) At the free end of this cable, connect the inner lead to hole A (S-1) and the shield lead to hole B (S-1) in the oscillator circuit board.

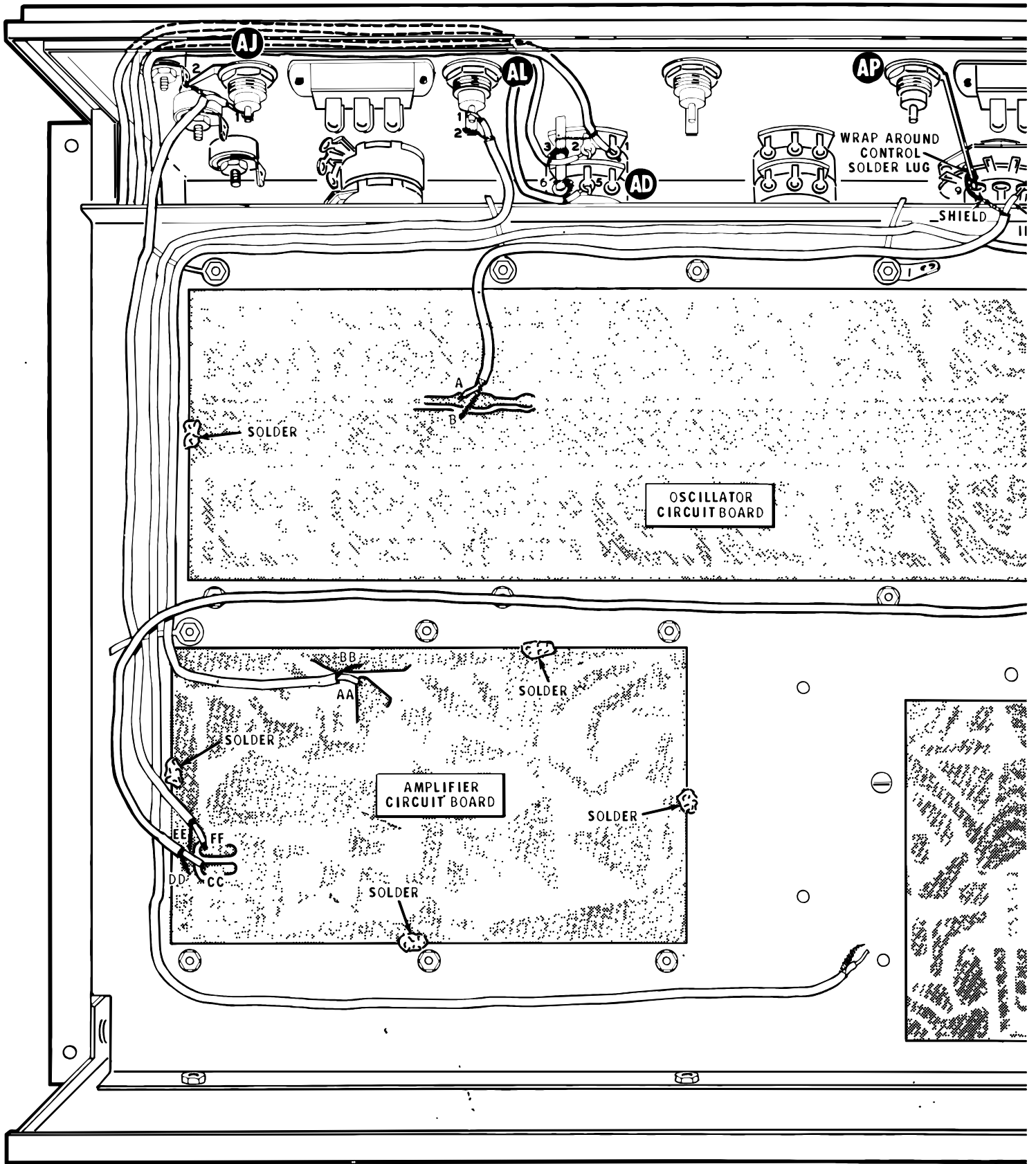

PICTORIAL 22



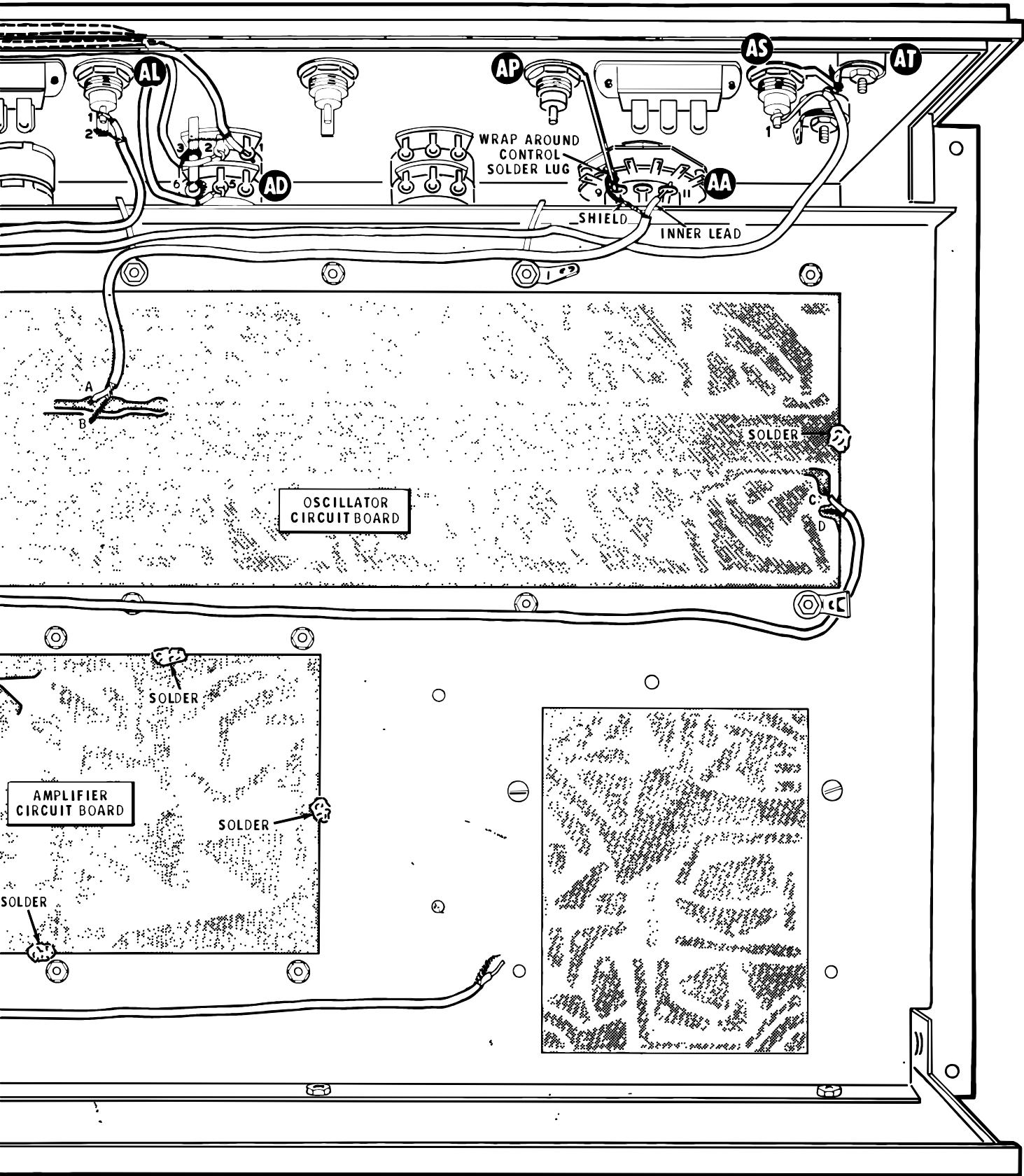

PICTORIAL 22



- (✓) At one end of a 17-1/2" coaxial cable, connect the inner lead to lug 1 of connector AS (S-1). Wrap the shield lead around the control solder lug at AS (S-1).
- (✓) At the free end of this cable, connect the inner lead to hole AA (S-1) and the shield lead to hole BB (S-1) in the amplifier circuit board.
- () At one end of a 16-1/2" coaxial cable, connect the inner lead to hole C (S-1) and the shield lead to hole D (S-1) in the oscillator circuit board.
- () At the free end of this cable, connect the inner lead to hole CC (S-1) and the shield lead to hole DD (S-1) in the amplifier circuit board.
- (✓) Position the coaxial cables as shown in the Pictorial and secure them to the chassis with the #8 long lugs at the four locations shown.

This completes the wiring on the bottom of the chassis, except for the diode modulator which will be wired later.

CHASSIS TOP

Refer to Pictorial 23 (fold-out from this page) for the following steps.

- () Locate the free end of the long 17-1/2" coaxial cable coming from lugs 1 and 3 of front panel control AD.
- (✓) Connect the inner lead of this coaxial cable to hole M (S-1) and the shield lead to hole N (S-1) in the amplifier circuit board.
- (✓) Locate the free end of the coaxial cable coming from lugs 2 and 3 of control AD.
- () Connect the inner lead of this coaxial cable to hole T (S-1) and the shield lead to hole U (S-1) in the amplifier circuit board.

- (✓) Connect the inner lead of the remaining coaxial cable coming from lugs 5 and 6 of control AD to hole Y (S-1) and the shield lead to hole X (S-1) in the amplifier circuit board.

- () Loosely twist together the green, brown, and blue wires of the 6-wire cable coming from front panel control AA. Then position the 6-wire cable down underneath terminal strip CG.

- (✓) Connect the red wire of the 6-wire cable to lug 7 of terminal strip CG (NS).

Connect the remaining wires of the 6-wire cable to the feedthroughs on the sweep shield as follows:

<u>WIRE COLOR</u>	<u>CONNECT TO</u>
(✓) Orange	Feedthrough DF (S-2).
(✓) White	Feedthrough DG (S-2).
(✓) Green	Feedthrough DA (S-2).
(✓) Brown	Feedthrough DB (S-2).
(✓) Blue	Feedthrough DC (S-2).

- (✓) Connect a 1-3/4" red wire from lug 7 of terminal strip CG (NS) to feedthrough DD (S-2).

- (✓) Connect a 5" red wire from lug 6 of terminal strip CG (NS) to feedthrough DH (S-2).

- (✓) Connect an 11" red wire from lug 5 of terminal strip CG (NS) to hole L in the amplifier circuit board (S-1).

- () Locate the coaxial cable coming from grommet DJ in the sweep shield. Connect the inner lead of this cable to hole V in the amplifier circuit board (S-1). NOTE: Be sure the cut-off shield of this coaxial cable does not touch any other lead or connection. Hole W in the amplifier circuit board will not be used.



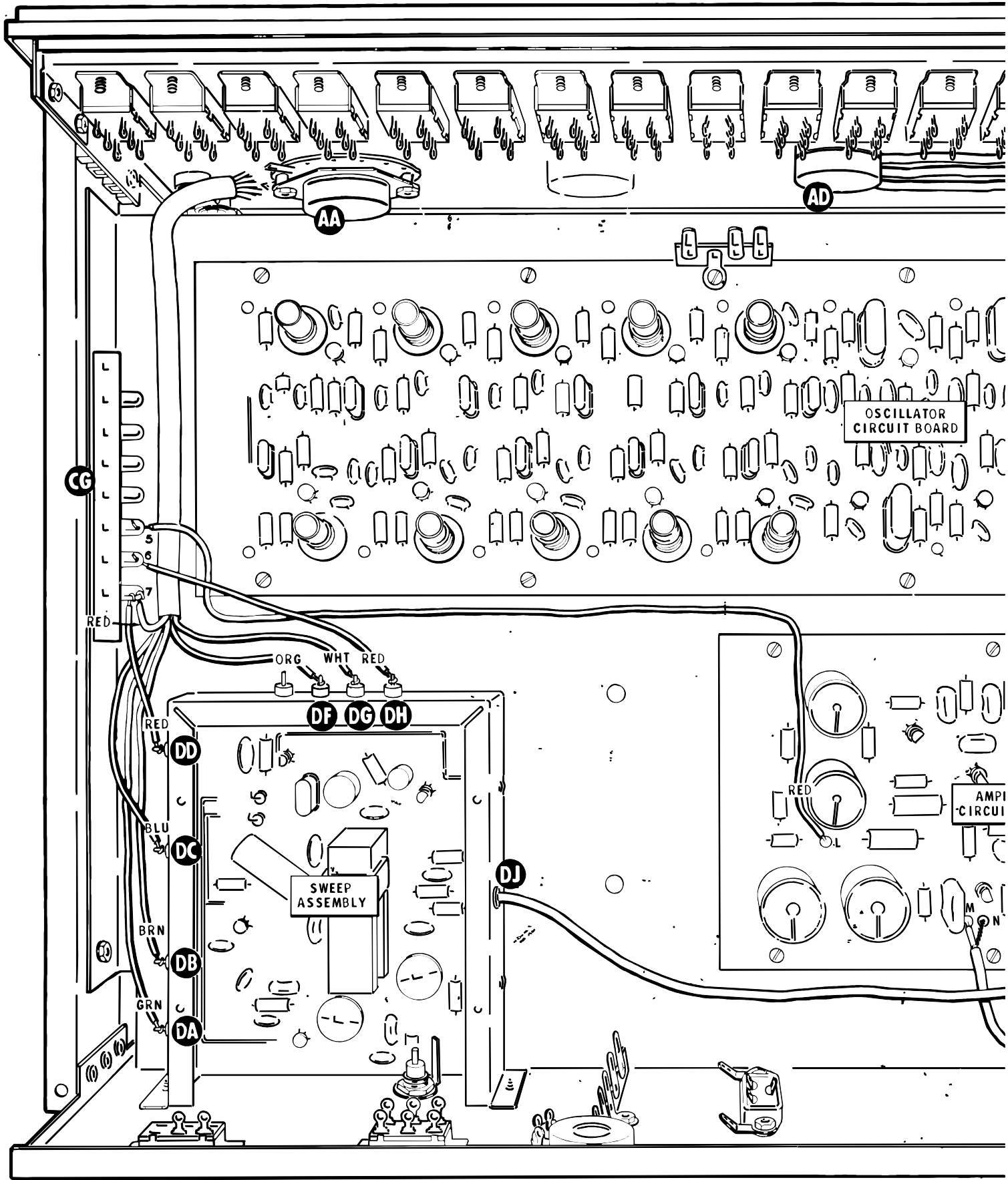

PICTORIAL 23

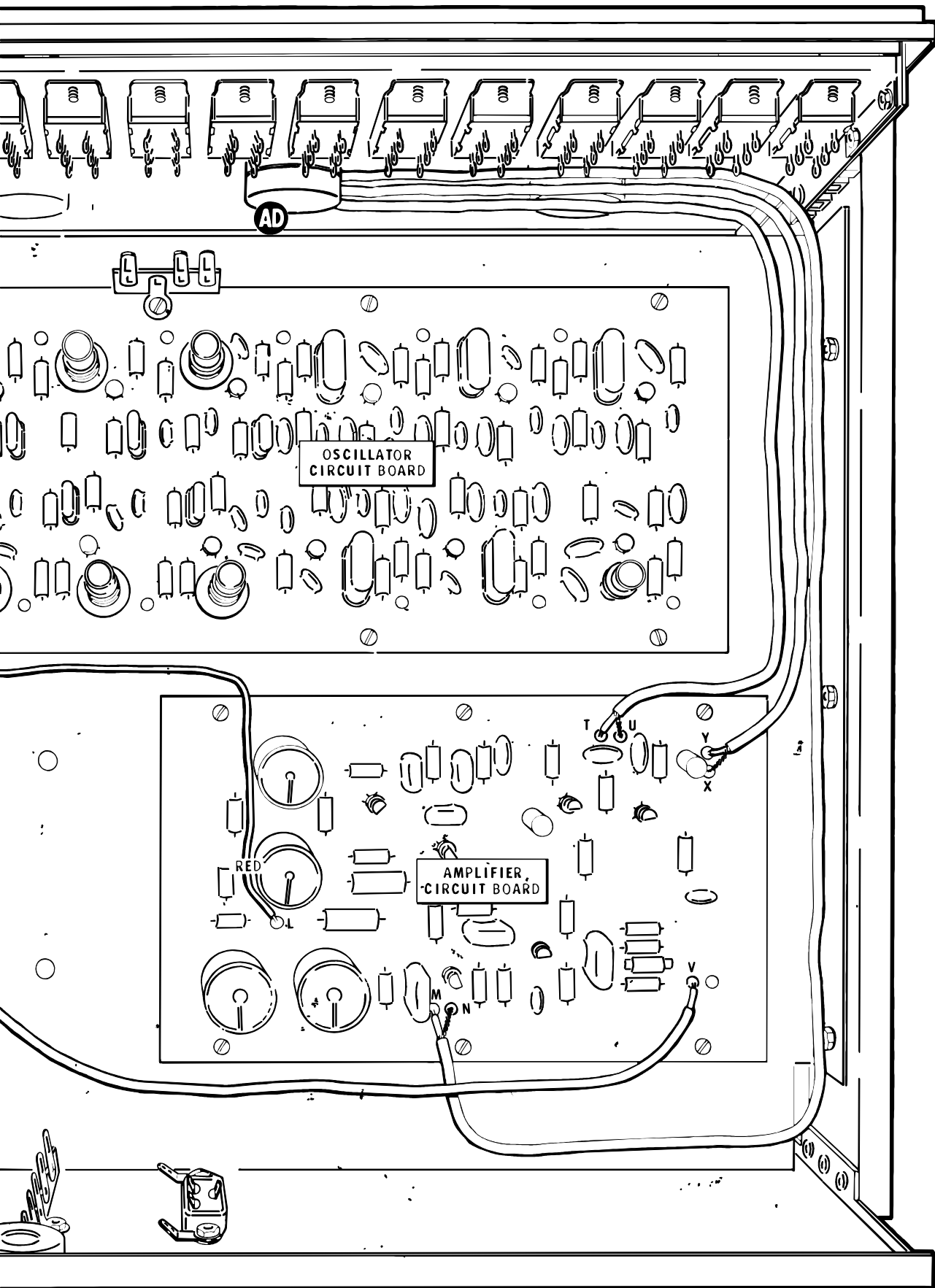

CTORIAL 23





Refer to Pictorial 24 for the following steps.

(✓) Connect a 27 k Ω (red-violet-orange) resistor from lug 1 (NS) to lug 2 (NS) of terminal strip CA.

() Locate the free end of the red, black, and white twisted wires from switch AR.

() Connect these wires to terminal strip BB on the rear panel as follows:

() Black to lug 5 (NS).

() Red to lug 4 (S-3).

(✓) White to lug 2 (NS).

(✓) Now position this 3-wire cable so it is tight against the front of the sweep-assembly chassis and the left end of the main chassis under the terminal strip CG. Keep the cable down against the chassis and away from the oscillator circuit board.

() Locate the free end of the twisted pair from switch AR and connect the ends to terminal strip CA as follows:

(✓) Black to lug 3 (NS).

(✓) White to lug 2 (S-2).

() Locate the free end of the twisted pair from switch AK.

() Connect this end of the red and black twisted pair to the holes in the amplifier circuit board as follows:

(✓) Red to hole K (S-1).

(✓) Black to hole J (S-1).

(✓) Position the twisted cables as shown in the Pictorial.

(✓) Remove and save a 2-1/2" length of insulation from a piece of red hookup wire. Cut the insulation into two 1-1/4" lengths.

() Locate the neon lamp (#412-15) and place 1-1/4" lengths of red insulation on both leads. Then insert the neon lamp into the red lens at AC.

(✓) Connect one insulated lead of the neon lamp to lug 3 (S-2) and the other insulated lead to lug 1 (S-2) of terminal strip CA.

() Prepare the following lengths of hookup wire:

11-1/2" white	13" blue
11" yellow	10-3/4" red
11" black	

() Place these five wires together so their ends are even at one end; then twist them together. Connect the end at which all five wires are even to rocker switch U as shown in inset drawing #1 on Pictorial 24.

() Yellow to lug 6 (NS).

() White to lug 6 (S-2).

() Red to lug 1 (S-1).

() Black to lug 3 (S-1).

() Blue to lug 4 (S-2).

Insert the ends of the 5-wire cable into the holes in the amplifier circuit board as indicated in the following steps. Solder each wire to the circuit board foil and cut off the excess lead lengths.

() Yellow to hole Z (S-1).

() Red to hole S (S-1).

() Black to hole R (S-1).

() White to hole P (S-1).

(✓) Blue to hole JJ (S-1).



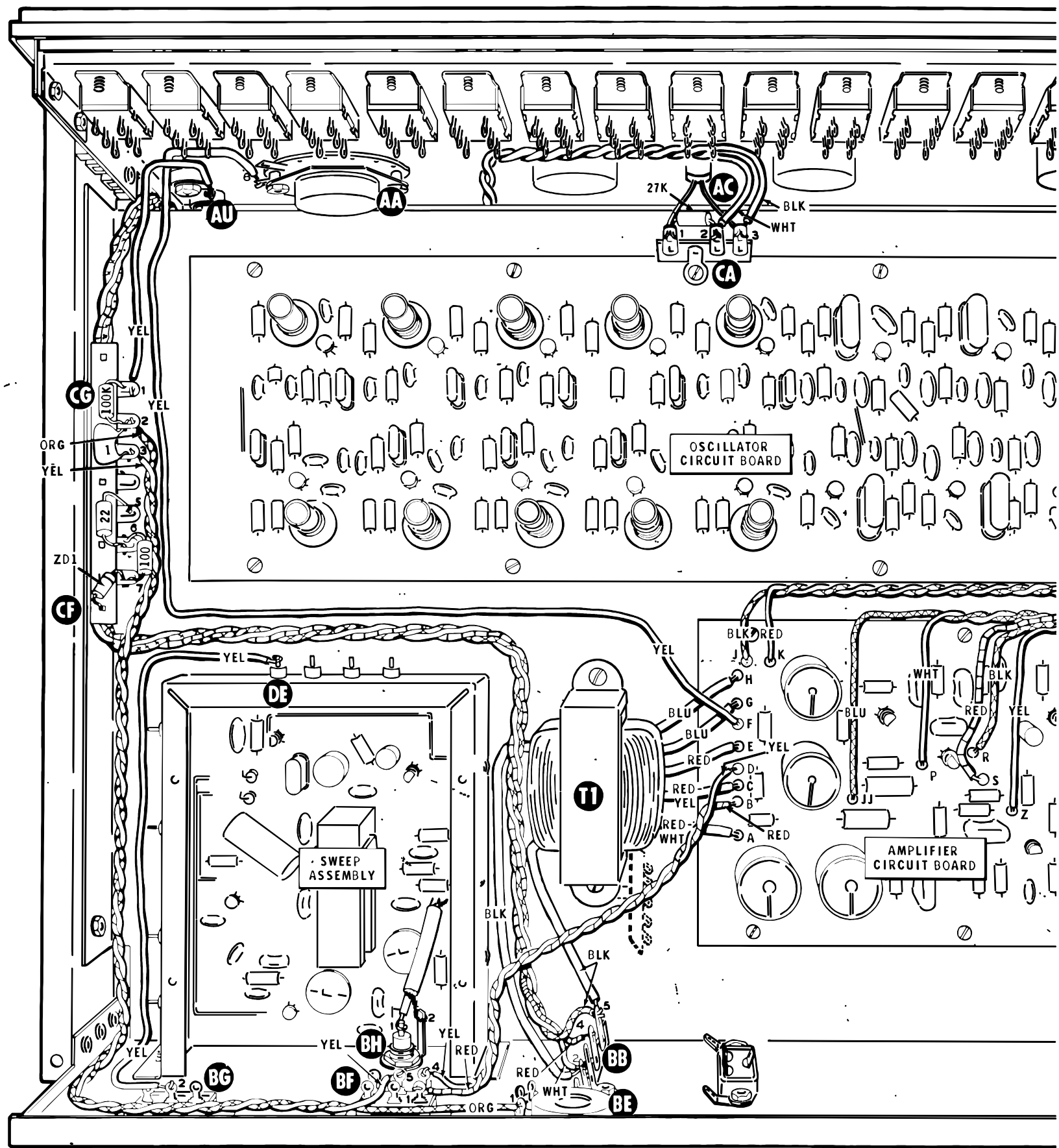

PICTORIAL 24

3/4 1/2 1/4 0

1"

2"

3"

4"

5"

6"

7"

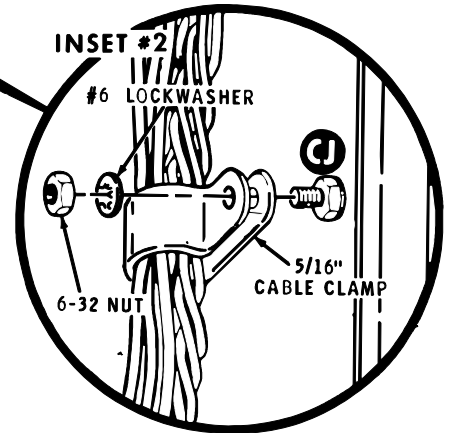
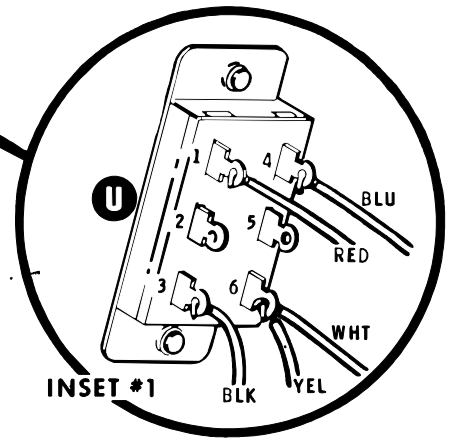
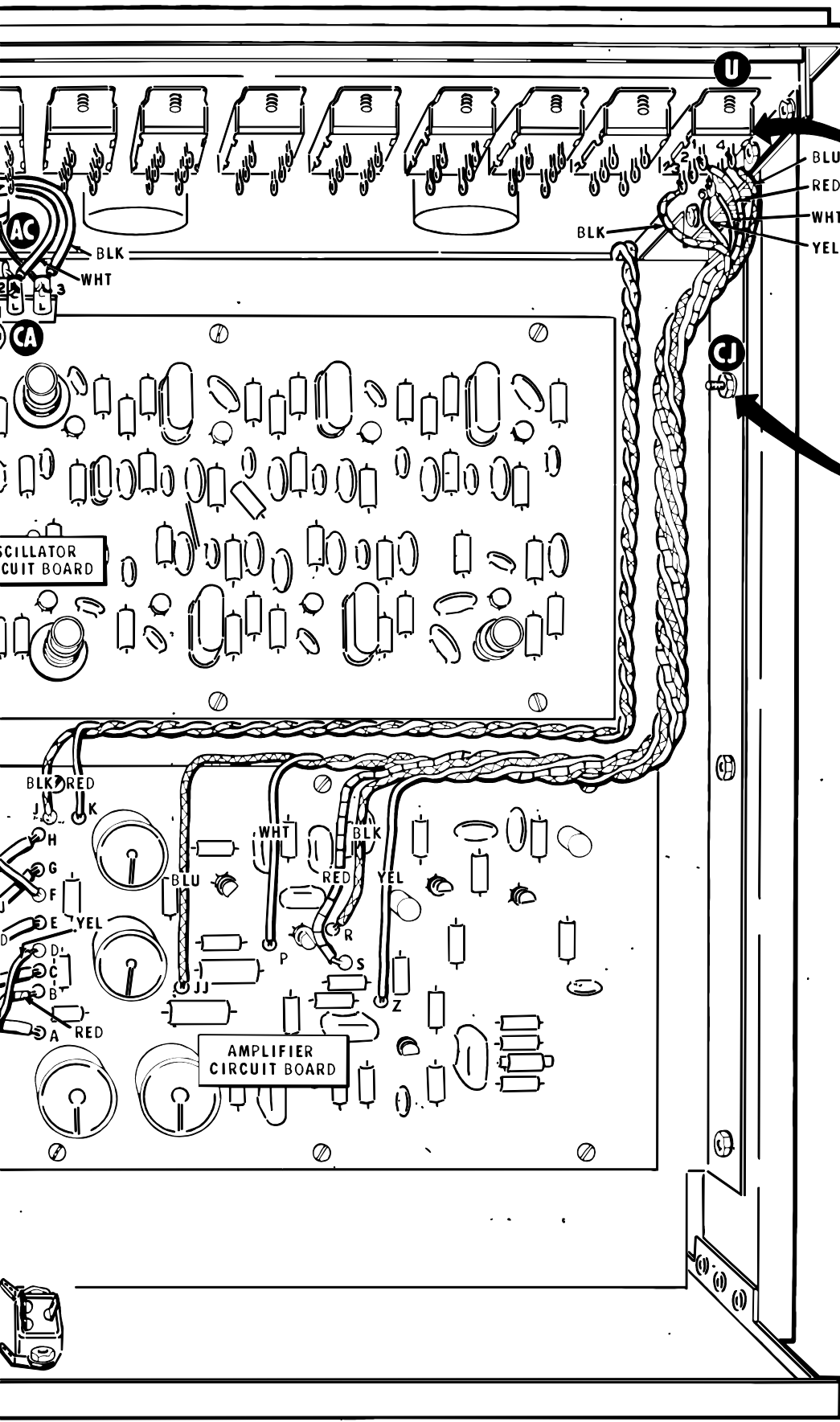

AL 24



- () Locate a 5/16" cable clamp and place the 5-wire twisted cable, the red and black twisted pair, and the three coaxial cables coming from the right front corner of the front panel into the cable clamp.
- (✓) Refer to inset drawing #2 on Pictorial 24 and secure the cable clamp at location CJ with a #6 lockwasher and a 6-32 nut.
- (✓) Connect one end of a 13" yellow wire to lug 8 of switch AA (S-1). Connect the other end of this wire to hole F in the amplifier circuit board (S-1).
- () Twist together a 14" yellow wire and a 14" orange wire.
- () At one end of this twisted pair, connect the orange wire to lug 2 (NS) and the yellow wire to lug 3 (NS) of terminal strip CG.
- (✓) At the other end of the twisted pair, connect the orange wire to lug 1 of control BE (S-1) and the yellow wire to lug 5 of switch BF (S-1). Position the twisted pair as shown in the Pictorial.
- (✓) Connect a 5" yellow wire from binding post AU (S-3) to lug 1 of terminal strip CG (NS).
- (✓) Connect a 100 k Ω (brown-black-yellow) resistor from lug 1 (S-2) to lug 2 (NS) of terminal strip CG.
- (✓) Connect a .1 μ F Mylar capacitor from lug 2 (S-3) to lug 3 (S-2) of terminal strip CG.
- (✓) Connect a 22 Ω (red-red-black) resistor from lug 5 (S-2) to lug 6 (NS) of terminal strip CG.

NOTE: The cathode end of a zener diode is marked with a color band or dot.

- (✓) Connect the lead at the cathode end of a zener diode (#56-45) to lug 7 of terminal strip CG (NS). Insert the other lead in eyelet CF of terminal strip CG (S-1).

- (✓) Connect a 100 Ω (brown-black-brown) resistor from lug 6 (S-3) to lug 7 (S-4) of terminal strip CG.
- (✓) Connect a 10-1/2" yellow wire from lug 2 of switch BG (S-1) to feedthrough DE on the sweep shield (S-2). Position this wire as shown in the Pictorial.
- (✓) Connect the inner lead of the large coaxial cable coming from holes H and J in the sweep circuit board to lug 1 (S-1) and the shield lead to lug 2 (S-1) of connector BH.
- () Refer to Detail 24A and cut the power transformer leads to the lengths indicated. Measure each lead from where it comes out of the transformer.

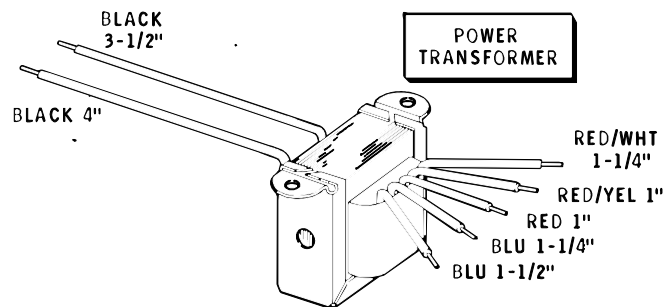

Detail 24A

CAUTION: Be careful when you remove the insulation from the transformer leads in the following step that you do not cut into the wire strands. To avoid internal damage, hold each lead where it comes out of the transformer when you remove the insulation.

- () Remove 1/4" of insulation from the end of each lead. If the strands are not already tinned, twist them together and apply a small amount of solder to the tip of each lead.

NOTE: Mount the transformer so the short colored leads are toward the amplifier circuit board.

() Connect the transformer leads to the amplifier circuit board holes as follows:

() Refer to Detail 24B and mount the transformer at T1 with 6-32 x 3/8" hardware. Mount a 5-lug terminal strip under the chassis at the hole nearest the rear of the unit. Align this terminal strip parallel to the chassis opening, with the foot away from the opening.

<u>LEAD COLOR</u>	<u>CONNECT TO HOLE</u>
() Long blue	H (S-1).
() Short blue	G (S-1).
() Red	E (S-1).
() Red-yellow	C (S-1).
() Red-white	A (S-1).

() Connect the shorter black lead to lug 5 of terminal strip BB (S-2).

(✓) Connect the other black lead to lug 2 of terminal strip BB (S-4).

() Twist together a 7" yellow wire and a 7" red wire.

() At one end of this twisted pair, connect the red wire to hole B (S-1) and the yellow wire to hole D (S-1) in the amplifier circuit board.

() At the other end of this twisted pair, connect the yellow wire to lug 4 (S-2) and the red wire to lug 1 (S-2) of switch BF.

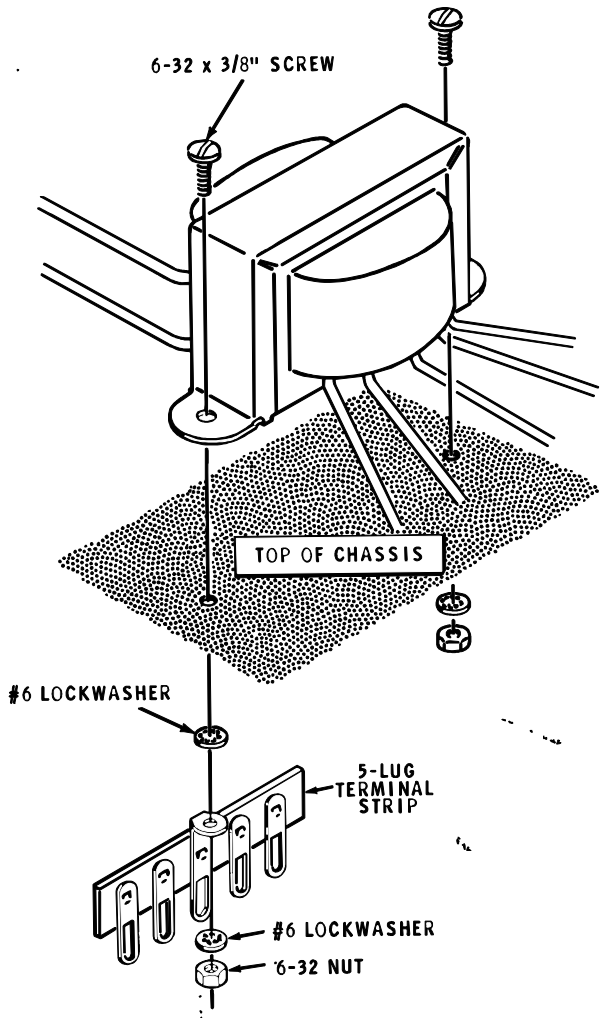

Detail 24B

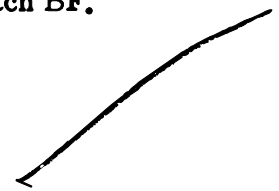

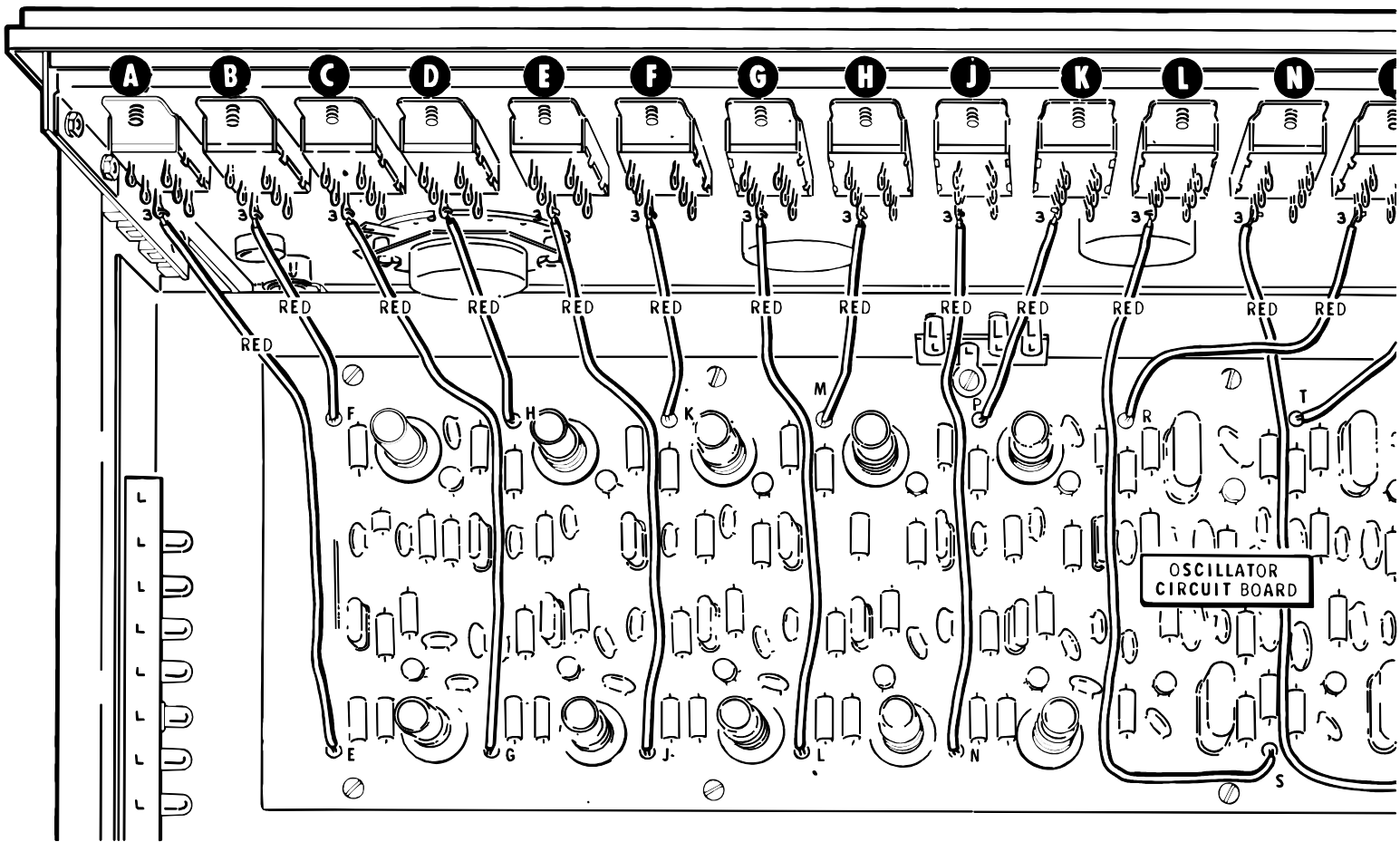

PICTORIAL 25

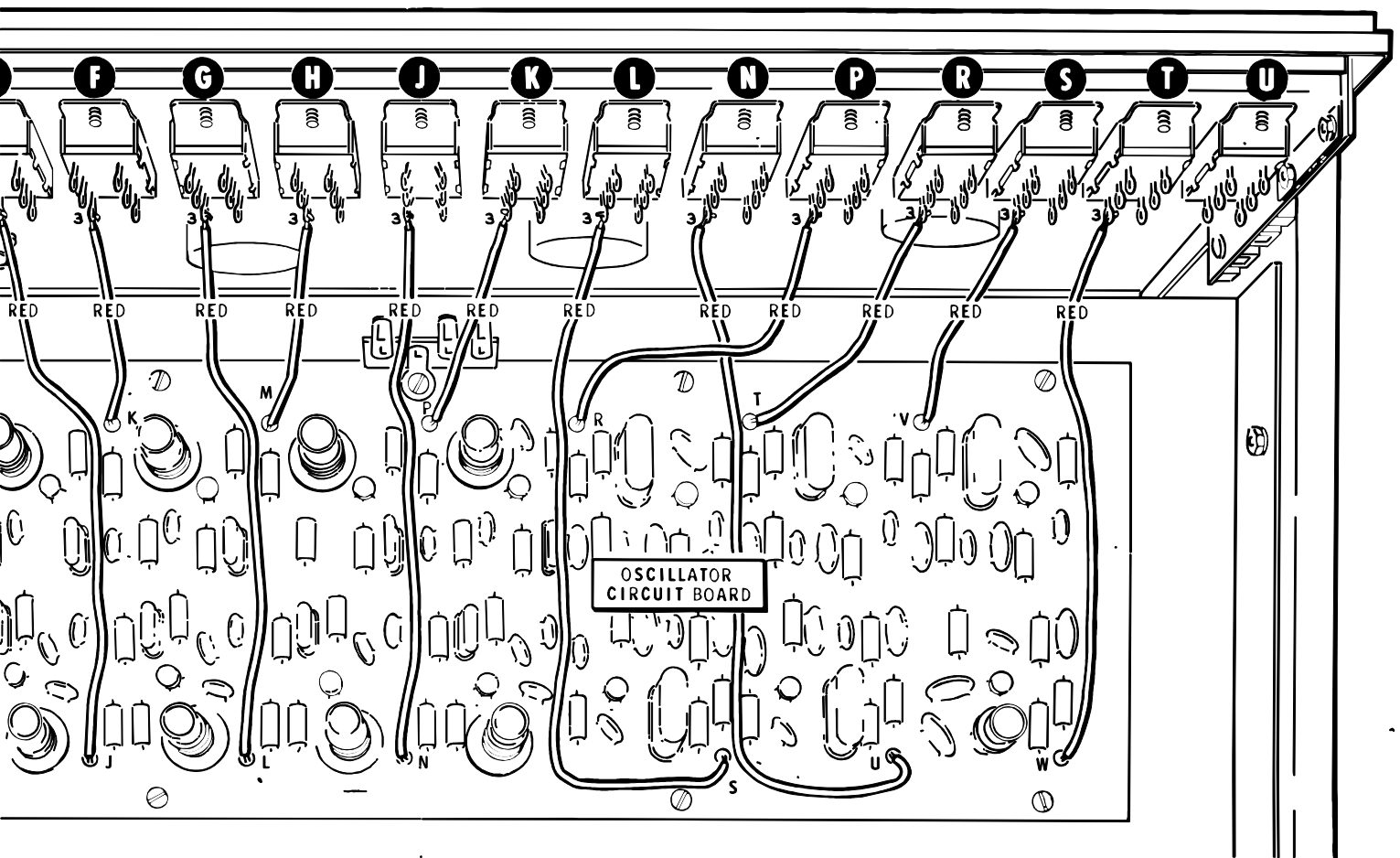

PICTORIAL 25

Refer to Pictorial 25 (fold-out from Page 42) for the following steps.

Prepare and connect the proper length of red wire called for in each step of the following chart. Position each wire as shown in the Pictorial. Press the red wires that go across the circuit board down close to the top of the board.

Wire length	From lug 3 of rocker switch:	To oscillator circuit board hole:
(✓) 5-1/2"	A (S-1)	E (S-1)
(✓) 3"	B (S-1)	F (S-1)
(✓) 5-1/2"	C (S-1)	G (S-1)
(✓) 3"	D (S-1)	H (S-1)
(✓) 5-1/2"	E (S-1)	J (S-1)
(✓) 3"	F (S-1)	K (S-1)
(✓) 5-1/2"	G (S-1)	L (S-1)
(✓) 3"	H (S-1)	M (S-1)
(✓) 5-1/4"	J (S-1)	N (S-1)
(✓) 2-3/4"	K (S-1)	P (S-1)
(✓) 6-3/4"	L (S-1)	S (S-1)
(✓) 7-1/4"	N (S-1)	U (S-1)
(✓) 3-1/2"	P (S-1)	R (S-1)
(✓) 2-3/4"	R (S-1)	T (S-1)
(✓) 2-3/4"	S (S-1)	V (S-1)
(✓) 6-1/2"	T (S-1)	W (S-1)

VSM

Refer to Pictorial 26 for the following steps.

- () Cut one lead of a 1 kΩ (brown-black-red) resistor to 1/2" and form a 1/8" foot as shown in inset #1 of Pictorial 26.

- (✓) Solder the foot to point H on the foil side of the generator circuit board. The other end will be connected later.

- (✓) Connect a 22 pF resin capacitor from lug 2 (NS) to lug 4 (NS) of the terminal strip.

- (✓) Connect a 22 pF resin capacitor from lug 1 (NS) to lug 5 (NS) of the terminal strip, as shown in inset #2.

NOTE: In the following step, be sure the crystal diode is positioned 3/8" from the terminal strip with the banded end as shown.

- (✓) Connect a crystal diode from lug 1 (NS) to lug 2 (NS) of the terminal strip.

- (✓) Connect a 75 Ω (violet-green-black) resistor from lug 3 (NS) to lug 4 (NS) of the terminal strip.

- (✓) Connect a 1.2 μH choke from lug 2 (NS) to lug 5 (S-2) of the terminal strip.

- () Connect the inner lead of the shielded cable coming from connector AL to lug 4 (S-3) of the terminal strip. Route the shield under the 22 pF capacitor.

- (✓) Connect the shield of the cable coming from AL to lug 3 (S-2) of the terminal strip.

- () Connect a 10-1/2" yellow wire to lug 1 (S-3) of the terminal strip.

- () Pass the other end of this wire through the terminal strip at CB (NS) and connect it to the solder lug of CC (S-1). Press this wire against the chassis.

This completes the wiring, except for one end of one resistor, of your Heathkit TV Post-Marker/Sweep Generator. Carefully inspect all connections for loose wires or unsoldered joints. Remove all wire clippings or particles of solder that may be lodged in the wiring. Be sure no solder bridges exist between the circuit board foils. Route wires so no ungrounded bare wire touches the chassis or other part or connection. The cabinet half-shells, handles, end caps, and feet will be mounted in the Final Assembly section of the Manual.



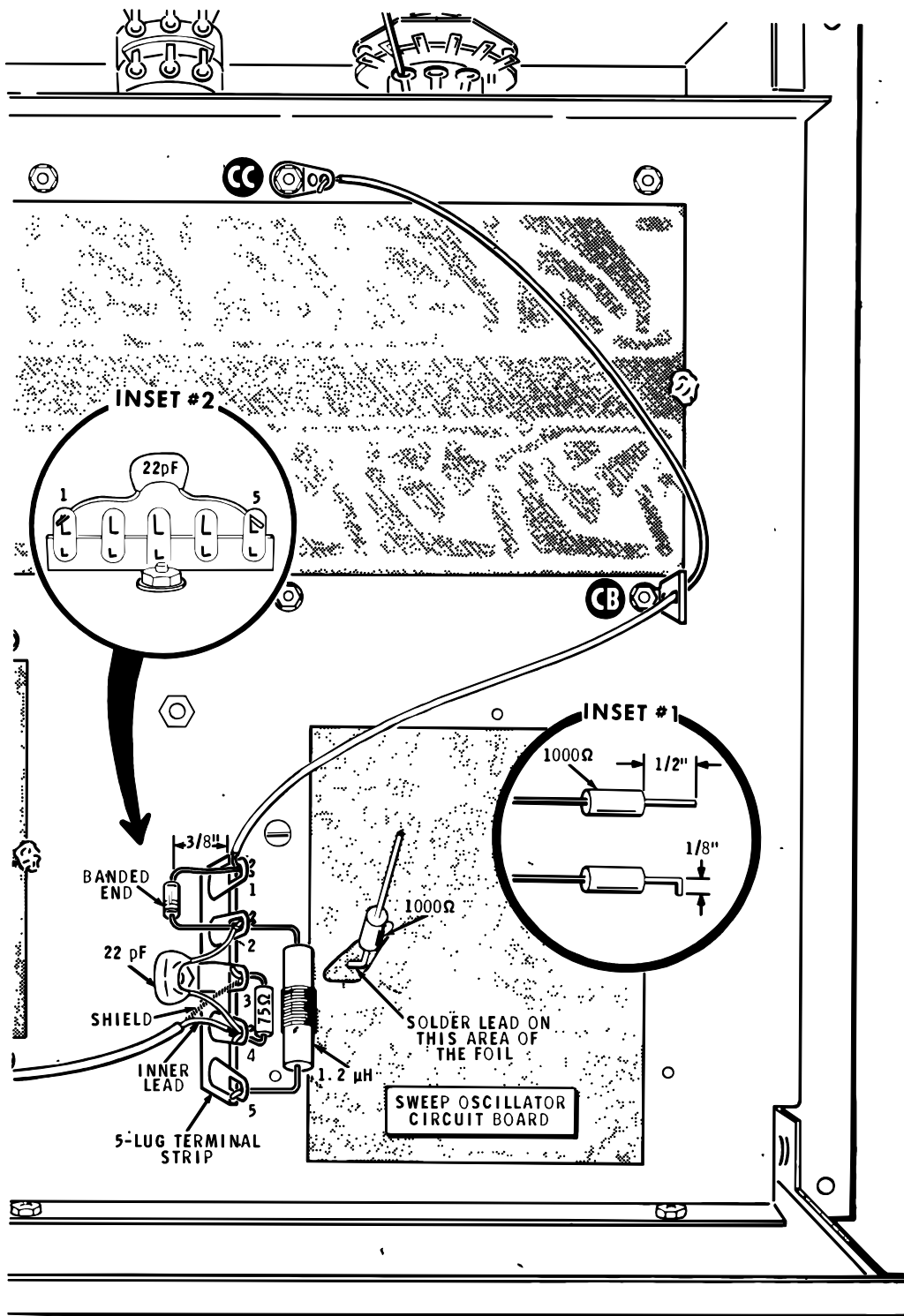

PICTORIAL 26



PREPARING CABLES

() Locate the two lengths of the large coaxial cable.

() Cut the 8' length into two 4' lengths.

Cut the 9-1/2' length as follows:

() One 4' length.

() One 3' length.

() One 2' length.

Discard the remaining piece.

() Refer to Part 1 of Detail 27A and prepare both ends of the 2' cable as shown in the Detail.

NOTE: When you open the envelope containing the coaxial plugs, be sure you do not lose the small centerpin.

() Refer to Part 2 of Detail 27A and install coaxial plugs (#432-58) on both ends of the prepared 2' coaxial cable. The center pin should be even with the plug insulator as shown in the Detail.

This completed cable is the Attenuator cable. Lay it aside for future use.

() Again refer to Part 1 of Detail 27A and prepare one end of each of the remaining four coaxial cables.

() Refer to Part 2 of Detail 27A and install coaxial plugs (#432-58) on the prepared ends of these four coaxial cables.

NOTE: LOCATE THE SWEEP SHIELD COVER #205-727 BEFORE YOU PREPARE THE SHIELDED CABLES. THE SHIELD COVER WILL BE USED AS A WRENCH TO HOLD THE PLUG WHILE YOU TIGHTEN THE NYLON NUT.

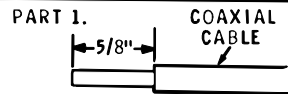

REMOVE 5/8" OF BOTH THE OUTER INSULATION AND THE SHIELD. CAUTION: BE SURE YOU DO NOT CUT THROUGH THE INSULATION ON THE INNER LEAD.

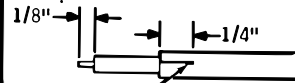

REMOVE 1/8" OF INSULATION FROM INNER LEAD.

CUT THREE 1/4" SLITS 120° APART IN OUTER INSULATION. CAUTION: DO NOT CUT INTO THE SHIELD.

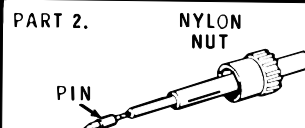

SOLDER THE SMALL PIN TO THE INNER LEAD AND SLIDE THE NYLON NUT OVER THE CABLE.

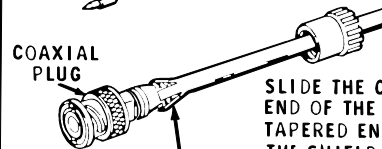

SLIDE THE COAXIAL PLUG OVER THE END OF THE CABLE. PUSH THE TAPERED END OF THE PLUG UNDER THE SHIELD AS FAR AS IT WILL GO. SHIELD AND OUTER INSULATION SHOULD FLARE OUT OVER TAPERED END OF PLUG.

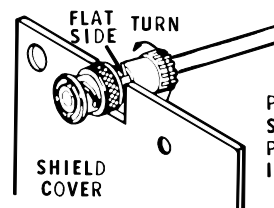
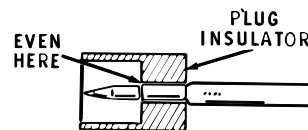
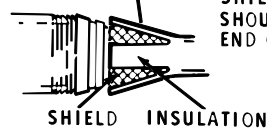

PLACE THE PLUG IN THE NOTCH. SLIDE THE NYLON NUT ONTO THE PLUG AND TURN THE NUT UNTIL IT IS TIGHT.

Detail 27A

CLIP LEAD CABLE

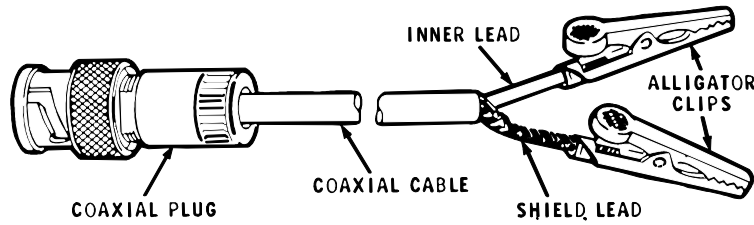

PICTORIAL 27

Clip Lead Cable

Refer to Pictorial 27 for a view of the completed Clip Lead Cable.

- () Refer to Detail 27B and prepare the free end of one of the 4' coaxial cables as shown.
- () Place a clip insulator (#73-34) on each lead.
- () Refer to Detail 27C and install alligator clips on the inner lead and the shield lead of this cable.
- () Place this cable aside for use later.

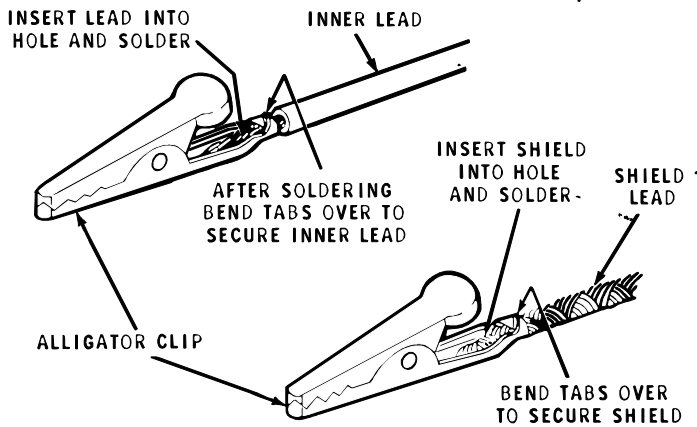

Detail 27C

PREPARE THE FREE END OF THE CABLE AS SHOWN BELOW.

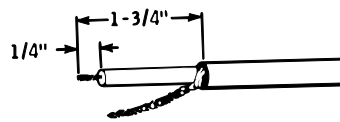

TAKING CARE NOT TO CUT THE VERY THIN WIRES OF THE SHIELD, REMOVE THE OUTER INSULATION.

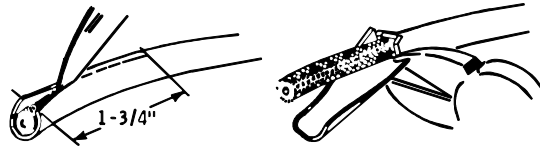

PUSH BACK THE SHIELD. THEN MAKE AN OPENING IN THE SHIELD AND BEND OVER AS SHOWN. PICK OUT THE INNER LEAD.



REMOVE 1/4" OF THE INNER INSULATION AND STRETCH OUT THE SHIELD. APPLY A SMALL AMOUNT OF SOLDER TO THE END OF THE SHIELD AND THE INNER LEAD. USE ONLY ENOUGH HEAT FOR THE SOLDER TO FLOW.

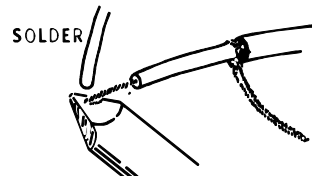

Detail 27B

Scope Vert Cable

NOTE: Three types of connectors are supplied for use on the leads of the Scope Vert Cable: alligator clips, banana plugs, or spade lugs. Use the connectors which will most easily attach to the vertical input of your oscilloscope.

- () Prepare the free end of the 3' coaxial cable as shown in Detail 27B.
- () Then refer to section A, B, or C of Detail 27D and install alligator clips, banana plugs, or spade lugs on the inner lead and shield lead of this cable. **NOTE:** If banana plugs are used, match the color of the plug insulator and the wire.
- () Place this cable aside for use later.

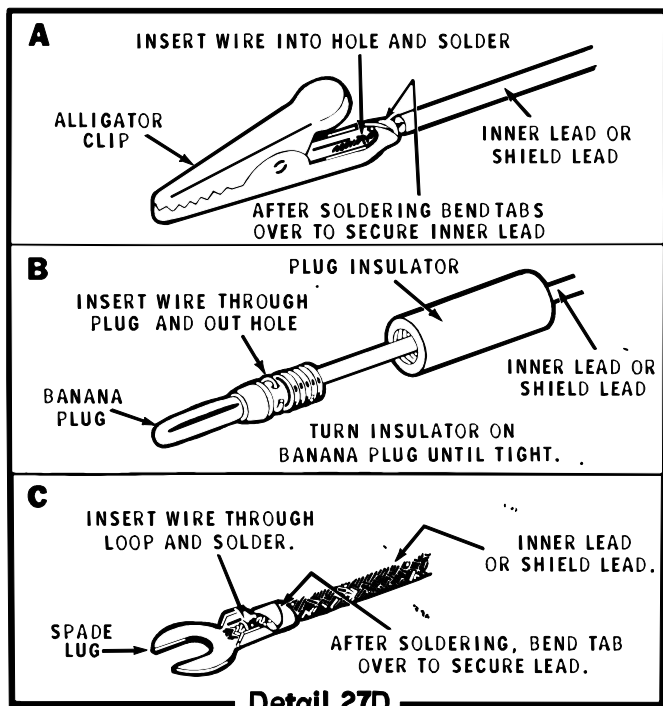

RF Cable

- () Prepare the free end of the two remaining coaxial cables as shown in Detail 28A. Apply a small amount of solder to the end of the inner lead and the shield lead.
- () Place one of these cables aside. It will be completed later.

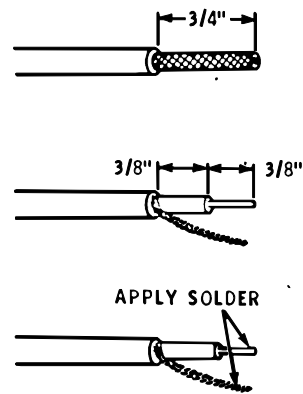

Detail 28A

Refer to Pictorial 28 for a view of the completed RF Cable.

- () Locate a 75 Ω (violet-green-black) resistor and cut off all but 3/8" of each lead. Then form a small loop at the end of each lead.

NOTE: In the following steps, make all connections as close as possible to the body of the resistor and capacitor. This will keep the assembly compact enough to fit into the pod shell.

Refer to Detail 28B for the following steps.

- () Connect the inner lead of a coaxial cable to either looped lead of the 75 Ω resistor (NS).
- () Connect one lead of a .001 μ F disc capacitor to the junction of the 75 Ω resistor and inner lead of the coaxial cable (S-3).

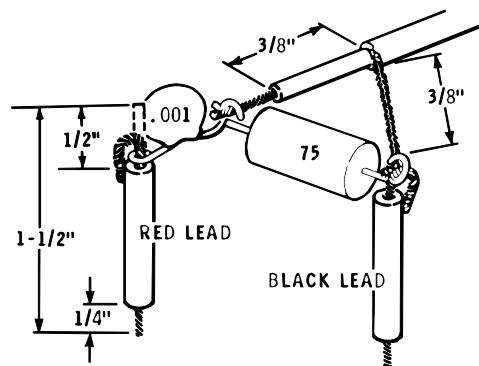

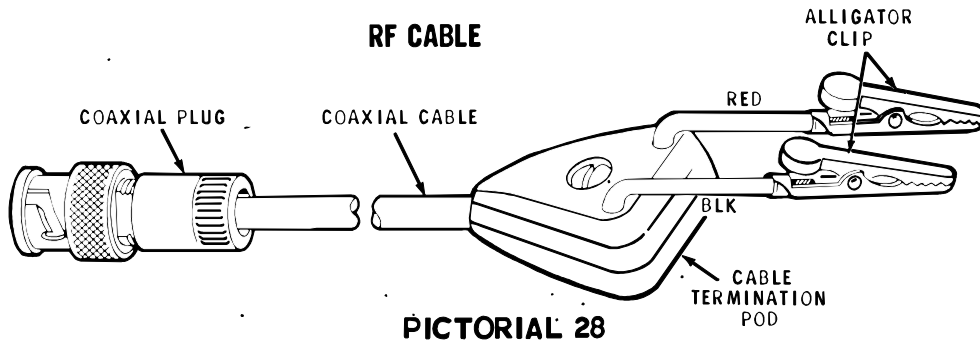

NOTE: When you prepare the short lengths of red and black wire in the next two steps, grip the wire very firmly to prevent pulling the strands out of the insulation.

- () Locate the lengths of large red and large black stranded wire and cut off a 1-1/2" length from each wire.
- () Hold the short lengths very securely and remove insulation from both ends of each short wire, as shown in Detail 28B. Apply a small amount of solder to the tip of each wire.
- () Refer to Detail 28B and wrap the free lead of the .001 μ F disc capacitor around the longer end of the short red wire; then double the wire over the lead so that about 1/4" overlaps the insulation (S-2). Cut off the excess capacitor lead lengths, but do not cut the wire.
- () Connect one end of the short black wire to the free end of the 75 Ω resistor (NS).
- () In a similar manner, connect the shield lead of the coaxial cable to the junction of the 75 ohm resistor and the short black wire (S-3). Maintain the indicated dimensions as closely as possible. Then cut off the excess lead lengths.
- () Refer to Detail 28C and insert the short red and black wires through the holes in the drilled shell (#75-15), and position the assembly in the shell as shown in the Detail.
- () Place the shell marked RF in position and secure the shells together with 4-40 x 1/2" hardware.
- () Place a clip insulator (#73-34) on each wire protruding from the pod.
- () Refer to Detail 28D and solder an alligator clip to the free end of each wire.

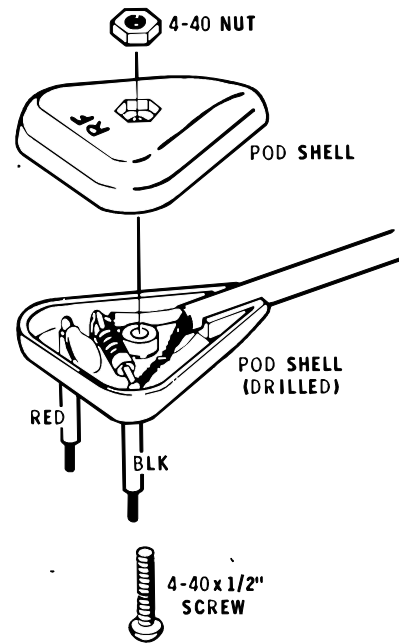

Detail 28C

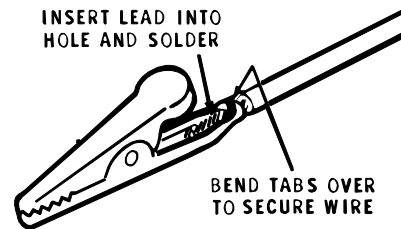

Detail 28D

This completes the assembly of the RF Cable. It will be used when you perform the steps in the Test and Adjustment section of the Manual.

Demodulator Probe

Refer to Pictorial 29 for a view of the completed Demodulator Probe.

NOTE: When you perform the following steps, make all connections as close as possible to the body of the resistor or capacitor.

Refer to Detail 29A for the following steps.

NOTE: Use the remaining prepared shielded cable in the following steps. Wrap each of the leads around its connecting point as shown and cut off the excess lead length.

- () Wrap one lead of a .001 μF disc capacitor around the shield lead of the coaxial cable (S-1). Then wrap the other lead around the inner lead of the coaxial cable (NS).
- () Connect one lead of a 10 k Ω (brown-black-orange) resistor to the junction of the inner lead and the .001 μF capacitor (S-3).
- () Wrap one lead of a 27 k Ω (red-violet-orange) resistor around the shield lead (S-1). Connect the other lead to the free lead of the 10 k Ω resistor (NS).

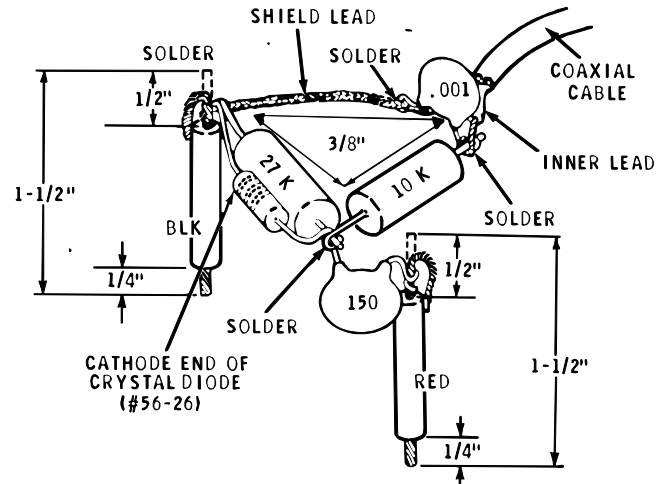

Detail 29A

NOTE: The cathode end of a crystal diode will be marked with color bands. Connect the diode as shown in the Detail. **CAUTION:** Form the leads of crystal diode #56-26 before it is installed to prevent breaking the diode. Use only enough heat to cause the solder to flow.

- () Wrap the lead at the cathode end of a crystal diode (#56-26) around the shield lead (S-1). Connect the other lead to the junction of the 27 k Ω and 10 k Ω resistors (NS).

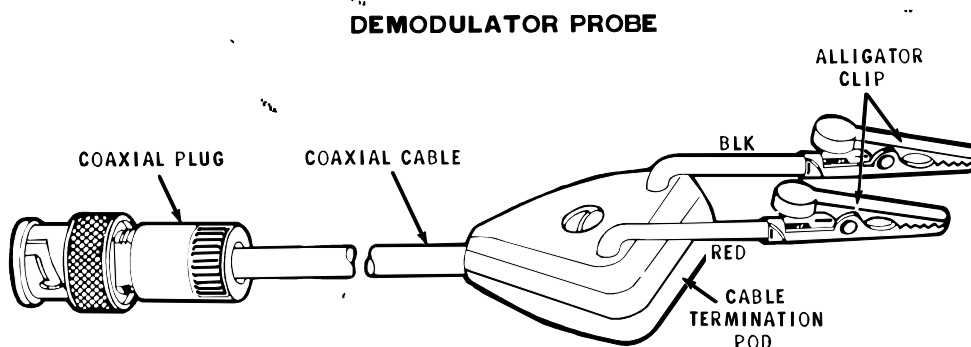

PICTORIAL 29

- () Connect one lead of a 150 pF disc capacitor to the junction of the crystal diode and the 27 kΩ and 10 kΩ resistors (S-4). The free end of the 150 pF capacitor will be connected later.
- () Again locate the lengths of large red and large black stranded wire and cut off a 1-1/2" length from each wire.
- () Hold the short lengths very securely and remove insulation from both ends of each wire as shown in Detail 29A. Apply a small amount of solder to the tip of each wire.
- () Connect the 1/2" end of the black wire to the end of the shield lead; then double the wire back over the lead (S-2).
- () Connect the 1/2" end of the red wire to the free lead of the 150 pF disc capacitor; then double the wire back over the lead (S-2).
- () Refer to Detail 29B and insert the short red and black wires through the holes in a drilled shell (#75-15), and position the assembly in the shell as shown in the Detail.
- () Place the plain shell in position and secure the shells together with 4-40 x 1/2" hardware.
- () Place a clip insulator (#73-34) on each wire protruding from the pod.
- () Refer to Detail 29C and solder alligator clips to the free ends of the wires.

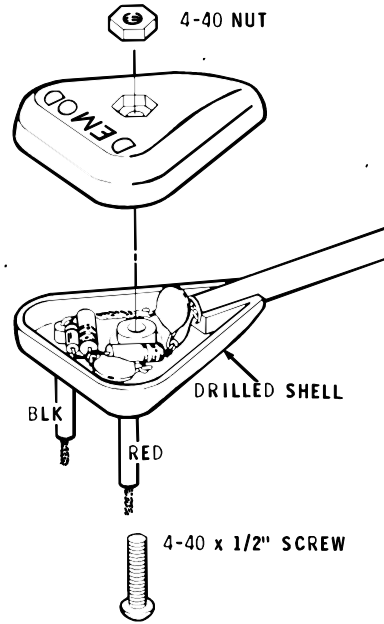

Detail 29B

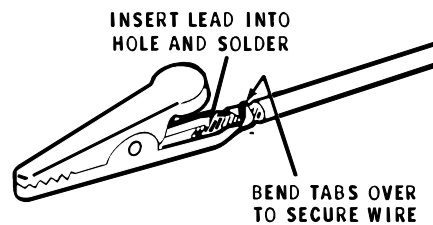

Detail 29C

BIAS LEADS

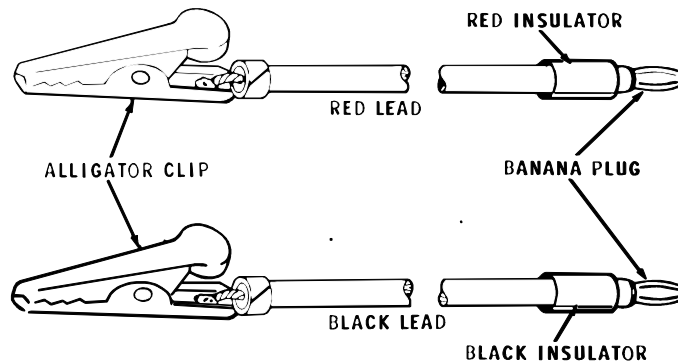

PICTORIAL 30

PREPARING LEADS

- () Locate the lengths of large red and large black stranded wire and cut each wire into two 3-foot lengths.
- () Refer to Part 1 of Detail 30A and remove 1/2" of insulation from each end of all four lengths of wire.
- () Refer to Part 2 of Detail 30A and install banana plugs on one end of each of the four wires. Be sure you match the color of the plug insulator with the color of the wire.
- () Place one prepared black and prepared red lead aside. They will be completed later.

Bias Leads

Refer to Pictorial 30 for a view of the completed bias leads.

- () Place a clip insulator (#73-34) on the free ends of one red and one black wire.
- () Refer to Detail 30B and solder alligator clips on the free ends of one red and one black wire.

This completes the preparation of the bias leads. Place them aside for use later.

PART 1

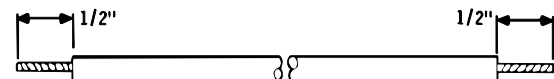

PART 2

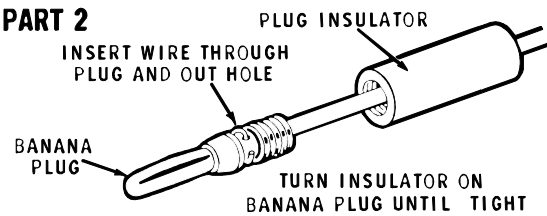

Detail 30A

INSERT WIRE INTO HOLE AND SOLDER

ALLIGATOR CLIP

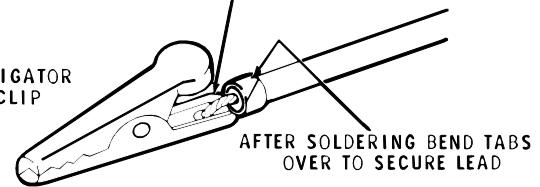

Detail 30B

SCOPE HORIZONTAL LEADS

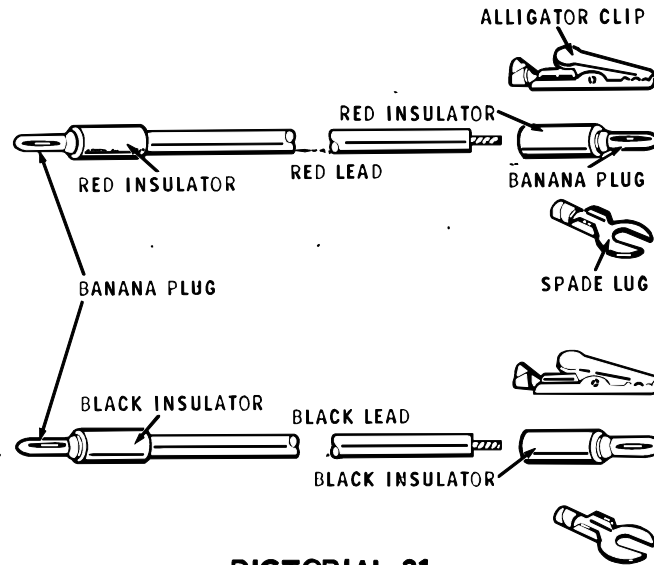

PICTORIAL 31

Scope Horizontal Leads

NOTE: Three types of connectors are supplied for use on the ends of the scope horizontal leads: alligator clips, banana plugs, or spade lugs. Use the connectors which will most easily attach to the horizontal input of your oscilloscope.

Refer to Pictorial 31 for a view of the completed scope horizontal leads.

() Refer to Detail 31A and install the connector best suited for your oscilloscope on the free ends of the remaining prepared black and red wires.

This completes the Cable and Lead preparation. Proceed to the steps for Attenuator Assembly and Wiring.

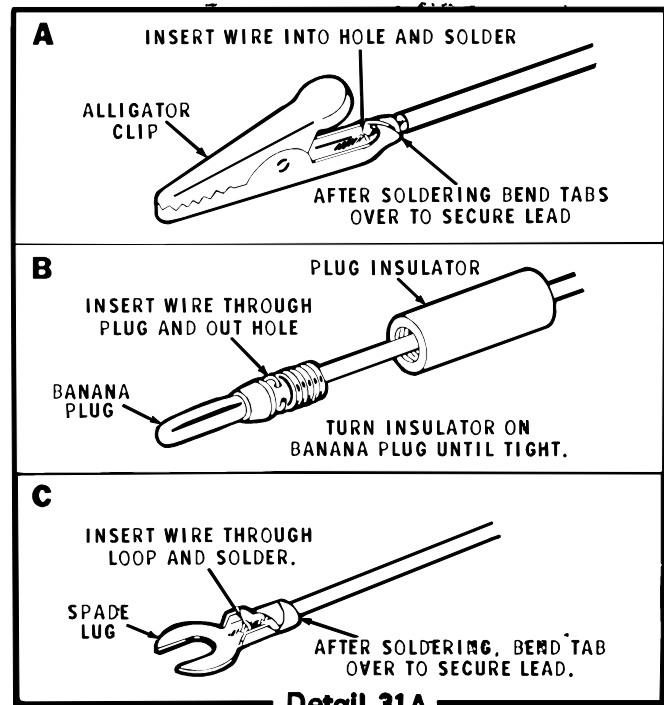

ATTENUATOR ASSEMBLY AND WIRING

ASSEMBLY

Refer to Pictorial 32 (fold-out from this page) for the following steps.

- () Locate the attenuator shield (#206-384) and position it as shown in the Pictorial.
- () Refer to Detail 32A and mount 7/8" spacers with 6-32 x 1/4" hardware at the four locations shown.

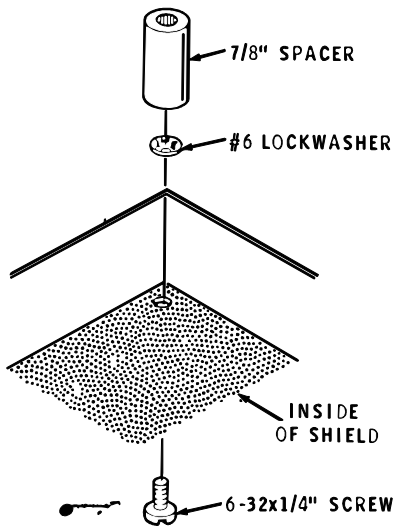

Detail 32A

- () Refer to Detail 32B and, using the length of large bare wire, solder a jumper wire between either two end lugs of a rocker switch (#60-48). Solder the wire to each lug; then cut off the wire close to the lug as shown. **NOTE:** placing the rocker switch in one of the openings in the attenuator shield will hold the switch steady while soldering.
- () In a like manner, prepare the remaining six #60-48 rocker switches.

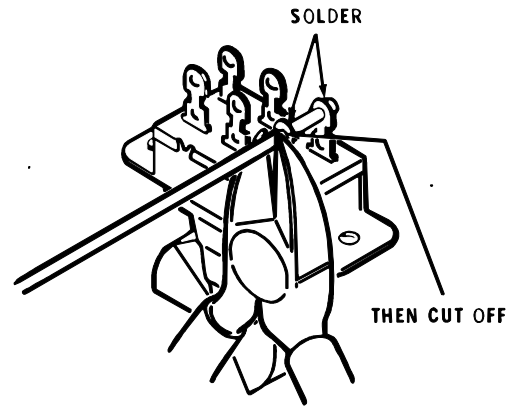

Detail 32B

Refer to Detail 32C for the following steps.

- () Locate a switch shield (#206-385) and position it over location EB as shown in Part 1 of Detail 32C. Then slide it between the solder tab and the bottom surface of the attenuator shield as shown in Part 2 of the Detail.

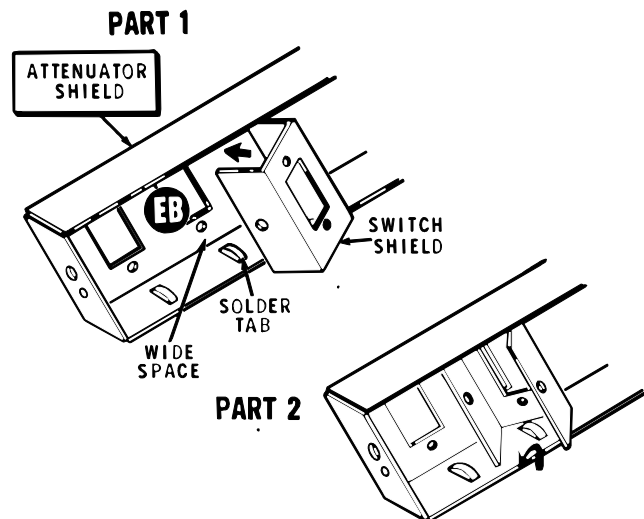

PART 3

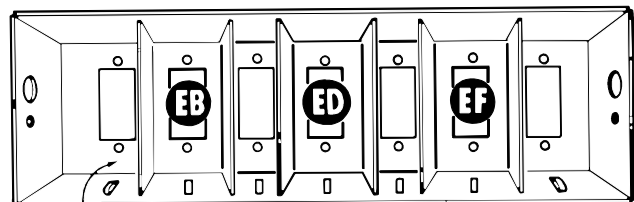

Detail 32C

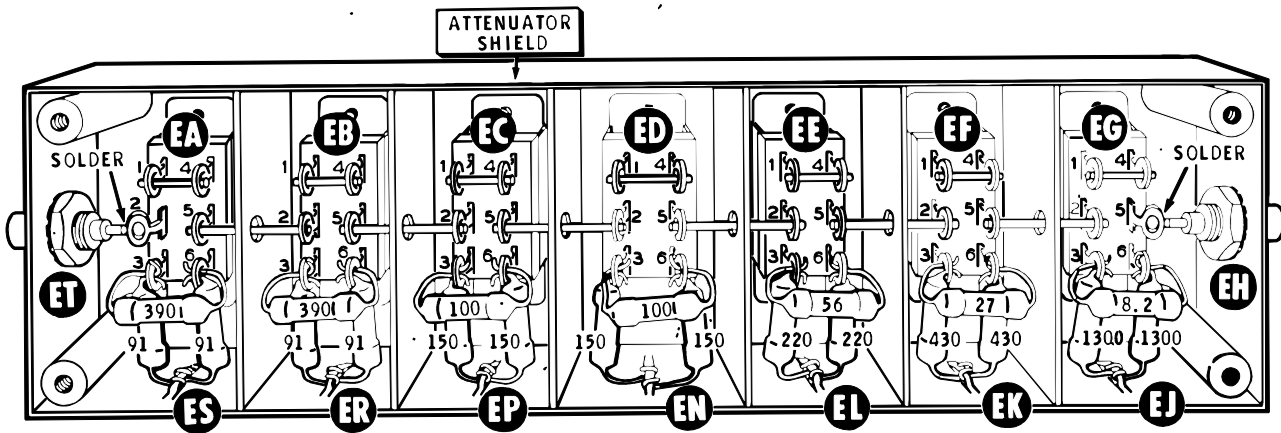

PICTORIAL 32

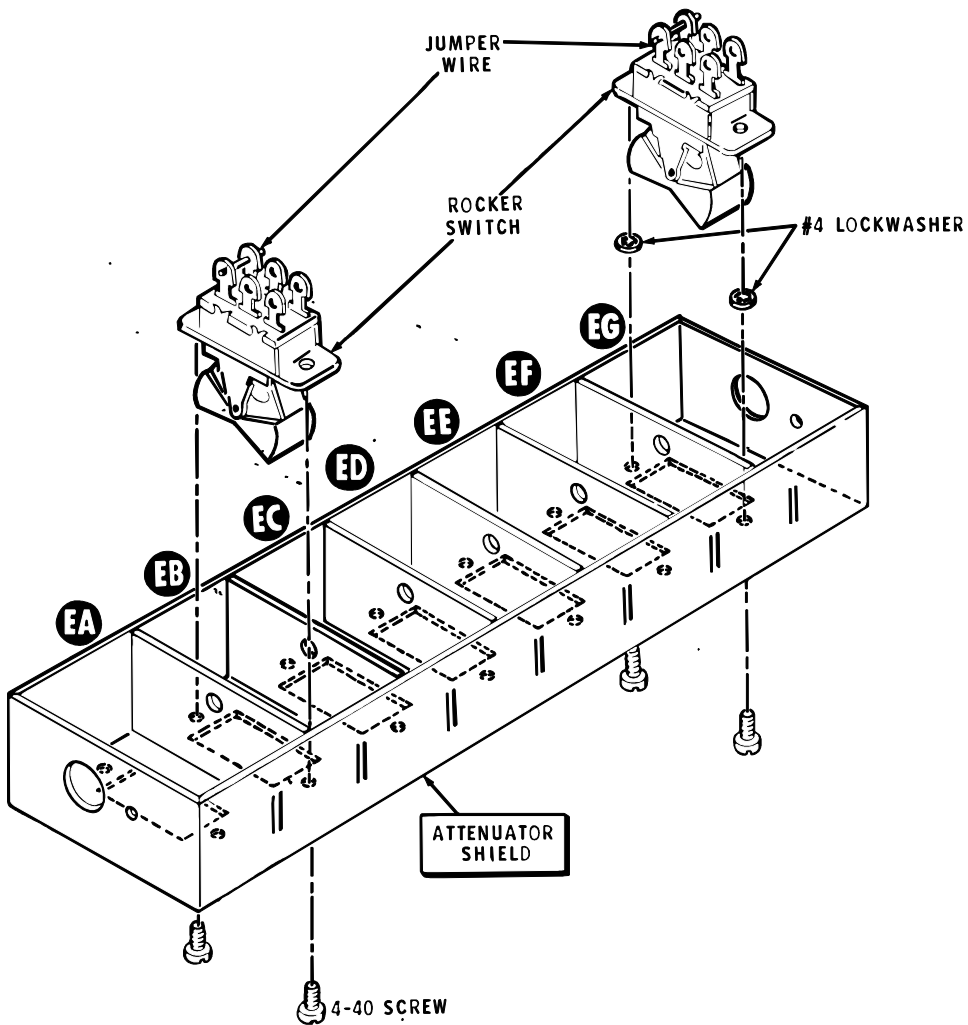

Detail 32 D



- () Now turn the switch shield until it is upright in the attenuator shield at location EB as shown in Part 3 of the Detail.
- () In a like manner, install switch shields at ED and EF.

NOTE: When you perform the following steps, be sure you install each prepared switch so the lugs with the jumper wire are positioned as shown in the Detail.

- () Refer to Detail 32D (fold-out from Page 52) and install prepared rocker switches at locations EB, ED, and EF with 4-40 x 1/4" hardware.

NOTE: When you install the four remaining rocker switches, use #4 lockwashers (one on each 4-40 screw) between the attenuator shield and the rocker switch frame.

- () Again refer to Detail 32D and install prepared rocker switches at locations EA, EC, EE, and EG with 4-40 x 1/4" hardware.

Refer to Detail 32E for the following steps.

NOTE: In the following steps, the three switch shields will be soldered to the sides of the attenuator shield. Set your soldering iron for "high-heat", or use another soldering iron with a higher heat rating. Solder approximately 1/4" of each end of each switch shield to the side of the attenuator shield.

- () Solder the switch shields to the attenuator shield at the twelve locations shown in Detail 32E.

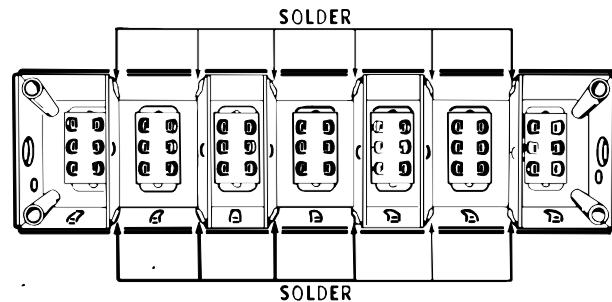

Detail 32E

- () After the solder has cooled, check each switch shield to be sure it is firmly soldered to the attenuator shield.

NOTE: In the next step, the remaining length of large bare wire will be "threaded" through the center lugs of the rocker switches in the attenuator.

- () Insert the large bare wire through the large hole at the left-hand end of the attenuator; then on through lugs 2 and 5 of rocker switches EA, EB, EC, ED, EE, EF, and through lug 2 only of switch EG.

- () Now solder lug 5 of rocker switch EA (S-2) and lug 2 of rocker switch EG (S-2). Then cut off the excess length of wire at lug 5 of switch EA.

- () Solder lugs 2 and 5 of switches EB through EF.

- () Now carefully cut out the wire between lugs 2 and 5 of switches EB, EC, ED, EE, and EF. See Pictorial 32.

Refer to Detail 32F for the following steps.

- () Position the attenuator top shell as shown and place the attenuator shield assembly inside the attenuator top shell.
- () Insert coaxial connectors (#432-59) through the holes in the ends of the attenuator top shell and shield.
- () Place the lockwashers and nuts on the coaxial connectors and tighten them only finger tight.
- () Start #6 x 3/8" black sheet metal screws into the holes at the two locations shown. Then turn the attenuator over and, while holding it down firmly, tighten both black sheet metal screws.
- () Now use a pair of long-nose pliers and tighten the mounting nuts on the coaxial connectors.
- () Check each switch to be sure the rocker operates freely.
- () If one (or more) rocker binds, mark the rocker and remove the attenuator top shell. Then loosen the switch mounting screws, slightly reposition the switch (or switches), and remount the attenuator top shell.
- () Refer to Pictorial 32 and, using a soldering aid or other pointed tool, bend lug 2 of switch EA over as shown. Then solder the switch lug to the centerpin of the coaxial connector.
- () In a like manner, bend lug 5 of switch EG over and solder it to the centerpin of the other coaxial connector.

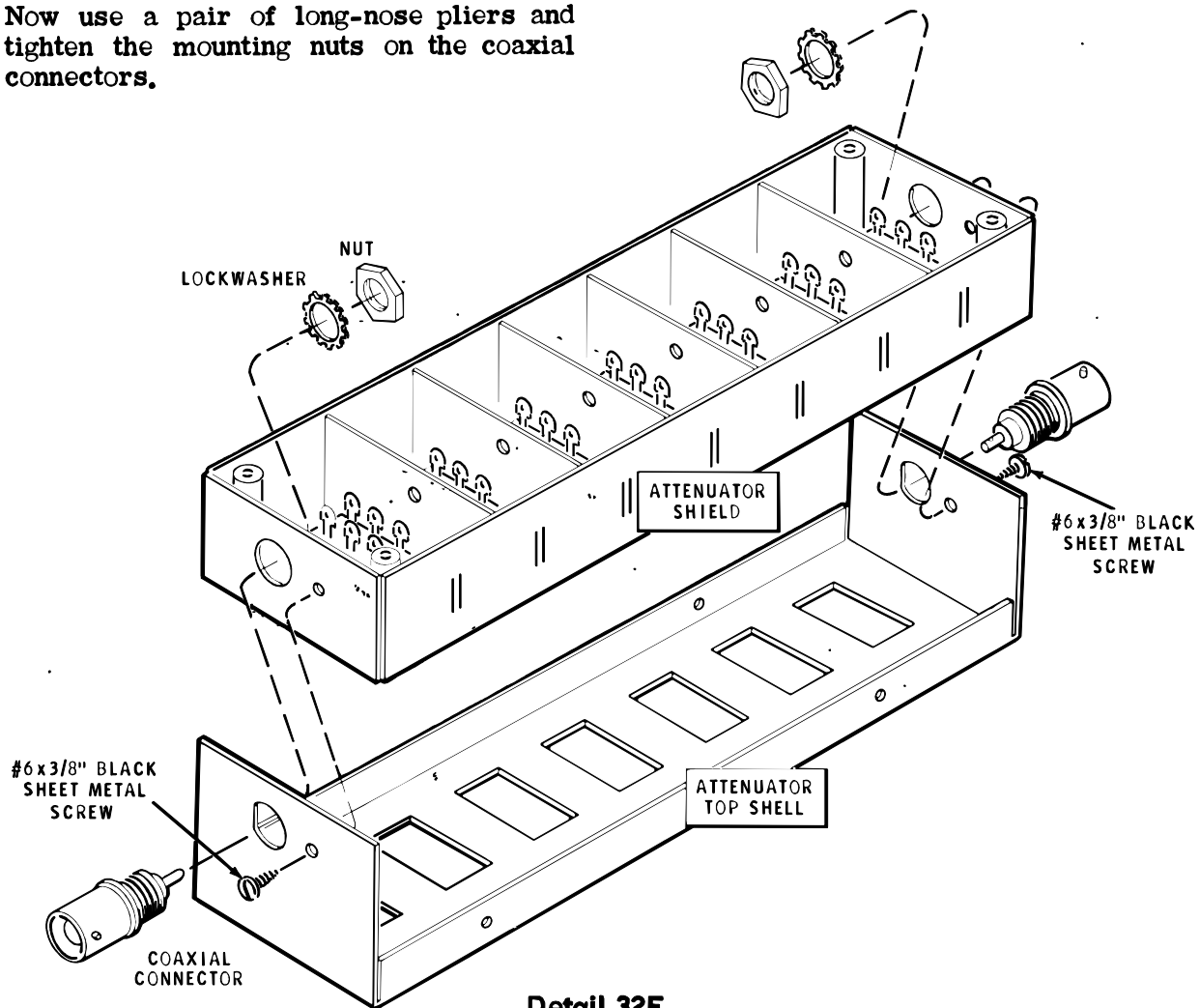

WIRING

NOTE: Except for the 8.2 Ω resistor, use only 1/2 watt low-noise resistors for the following steps. Do not grip the body of these resistors with pliers because this could damage the resistor. The resistor leads should be as short as possible and still allow for proper solder connections. Use enough heat to cause the solder to flow.

Refer to Pictorial 32 for the following steps.

NOTE: There may be one hole or two holes in each lug on the rocker switches. Use the hole nearest the end of the lug when you connect to the switch.

- (✓) Connect a 91 Ω (white-brown-black) resistor from lug 3 of switch EA (NS) to solder tab ES (NS).
- (✓) Connect a 91 Ω (white-brown-black) resistor from lug 6 of switch EA (NS) to solder tab ES (S-2).
- (✓) Connect a 390 Ω (orange-white-brown) resistor from lug 3 (S-2) to lug 6 (S-2) of switch EA.
- (✓) Connect a 91 Ω (white-brown-black) resistor from lug 3 of switch EB (NS) to solder tab ER (NS).
- (✓) Connect a 91 Ω (white-brown-black) resistor from lug 6 of switch EB (NS) to solder tab ER (S-2).
- (✓) Connect a 390 Ω (orange-white-brown) resistor from lug 3 (S-2) to lug 6 (S-2) of switch EB.
- (✓) Connect a 150 Ω (brown-green-brown) resistor from lug 3 of switch EC (NS) to solder tab EP (NS).
- (✓) Connect a 150 Ω (brown-green-brown) resistor from lug 6 of switch EC (NS) to solder tab EP (S-2).
- (✓) Connect a 100 Ω (brown-black-brown) resistor from lug 3 (S-2) to lug 6 (S-2) of switch EC.
- (✓) Connect a 150 Ω (brown-green-brown) resistor from lug 3 of switch ED (NS) to solder tab EN (NS).
- (✓) Connect a 150 Ω (brown-green-brown) resistor from lug 6 of switch ED (NS) to solder tab EN (S-2).
- (✓) Connect a 100 Ω (brown-black-brown) resistor from lug 3 (S-2) to lug 6 (S-2) of switch ED.
- (✓) Connect a 220 Ω (red-red-brown) resistor from lug 3 of switch EE (NS) to solder tab EL (NS).
- (✓) Connect a 220 Ω (red-red-brown) resistor from lug 6 of switch EE (NS) to solder tab EL (S-2).
- (✓) Connect a 56 Ω (green-blue-black) resistor from lug 3 (S-2) to lug 6 (S-2) of switch EE.
- (✓) Connect a 430 Ω (yellow-orange-brown) resistor from lug 3 of switch EF (NS) to solder tab EK (NS).
- (✓) Connect a 430 Ω (yellow-orange-brown) resistor from lug 6 of switch EE (NS) to solder tab EK (S-2).
- (✓) Connect a 27 Ω (red-violet-black) resistor from lug 3 (S-2) to lug 6 (S-2) of switch EF.
- () Connect a 1300 Ω (brown-orange-red) resistor from lug 3 of switch EG (NS) to solder tab EJ (NS).
- () Connect a 1300 Ω (brown-orange-red) resistor from lug 6 of switch EG (NS) to solder tab EJ (S-2).
- () Connect an 8.2 Ω (gray-red-gold) resistor from lug 3 (S-2) to lug 6 (S-2) of switch EG.

This completes the wiring of the attenuator. Be sure all connections are properly soldered and there are no wire clippings or particles of solder lodged in the switches. Also be sure the large bare wire between the switches does not touch the metal where it passes through the switch shields.



ATTENUATOR FINAL ASSEMBLY

Refer to Pictorial 33 for the following steps.

- () Locate the attenuator bottom shell and position it as shown. Then place the attenuator switch assembly in the bottom shell.
- () Secure the switch assembly to the bottom of the shell with 6-32 x 1/4" black screws at the four locations shown.
- () Secure the sides of the shell to the switch assembly with #6 x 3/8" black sheet metal screws at the four locations shown.

- () Locate the four small plastic feet (#261-29) and remove the paper backing from one foot.
- () Place the plastic foot on the bottom of the attenuator assembly 1/4" away from one of the black screws with one edge of the foot even with the edge of the bottom shell.
- () In a like manner, install the remaining three plastic feet on the bottom of the attenuator assembly.

This completes the assembly of the attenuator. Place it aside for further use.

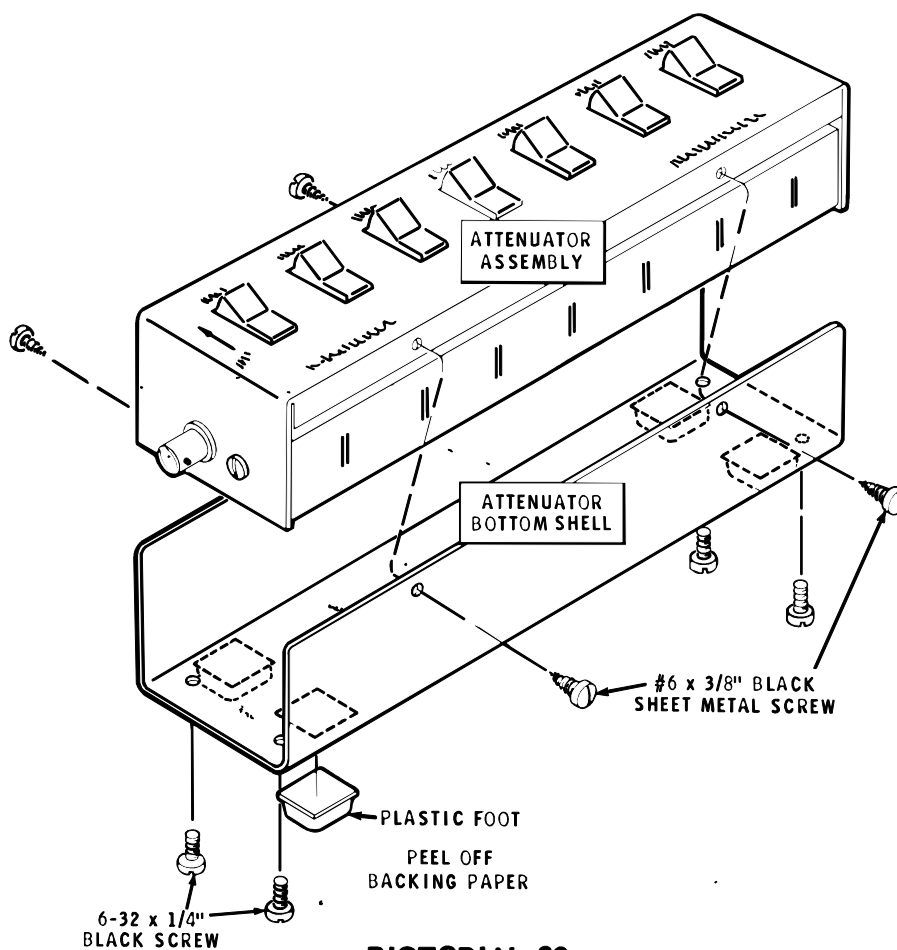

PICTORIAL 33

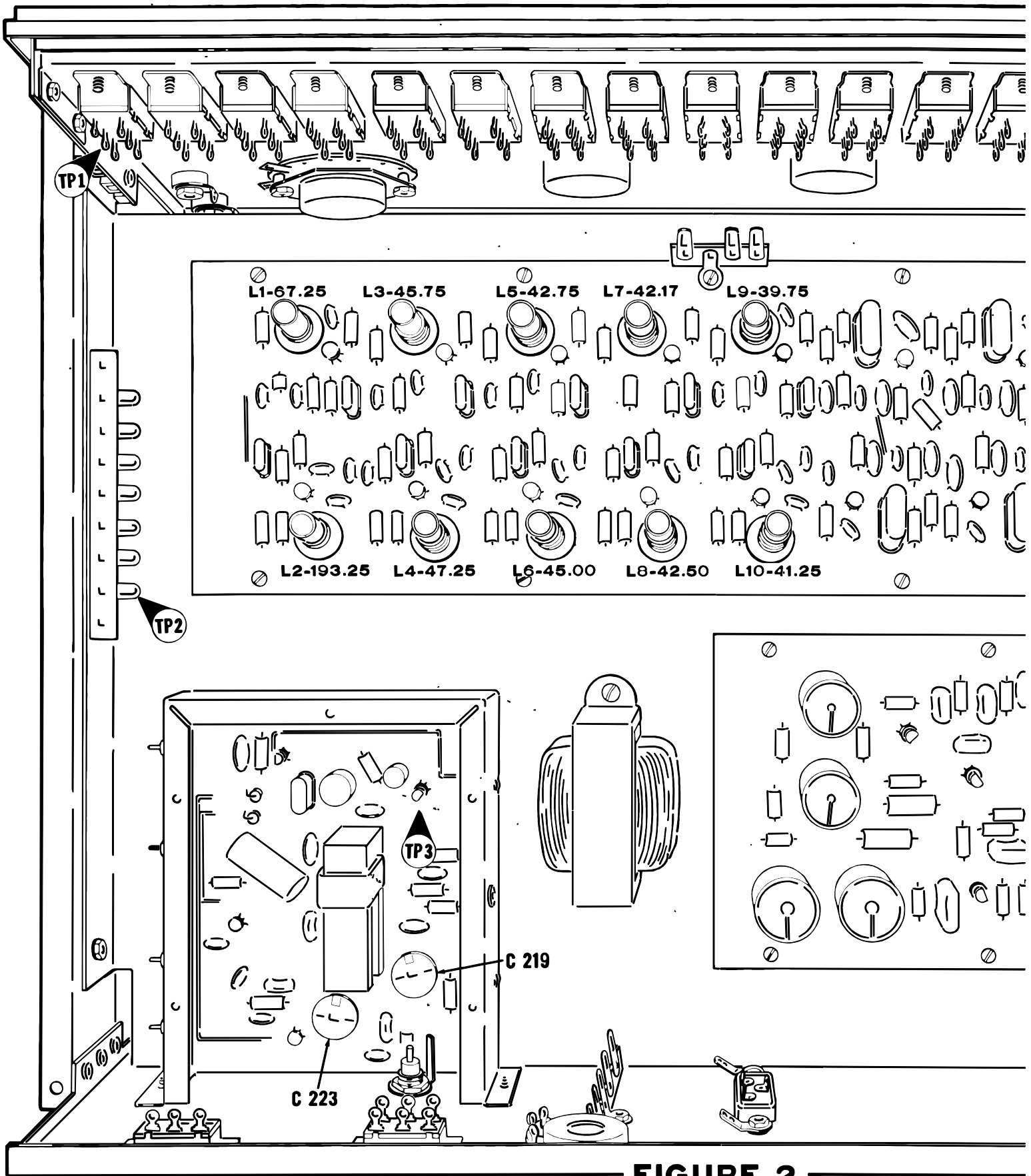

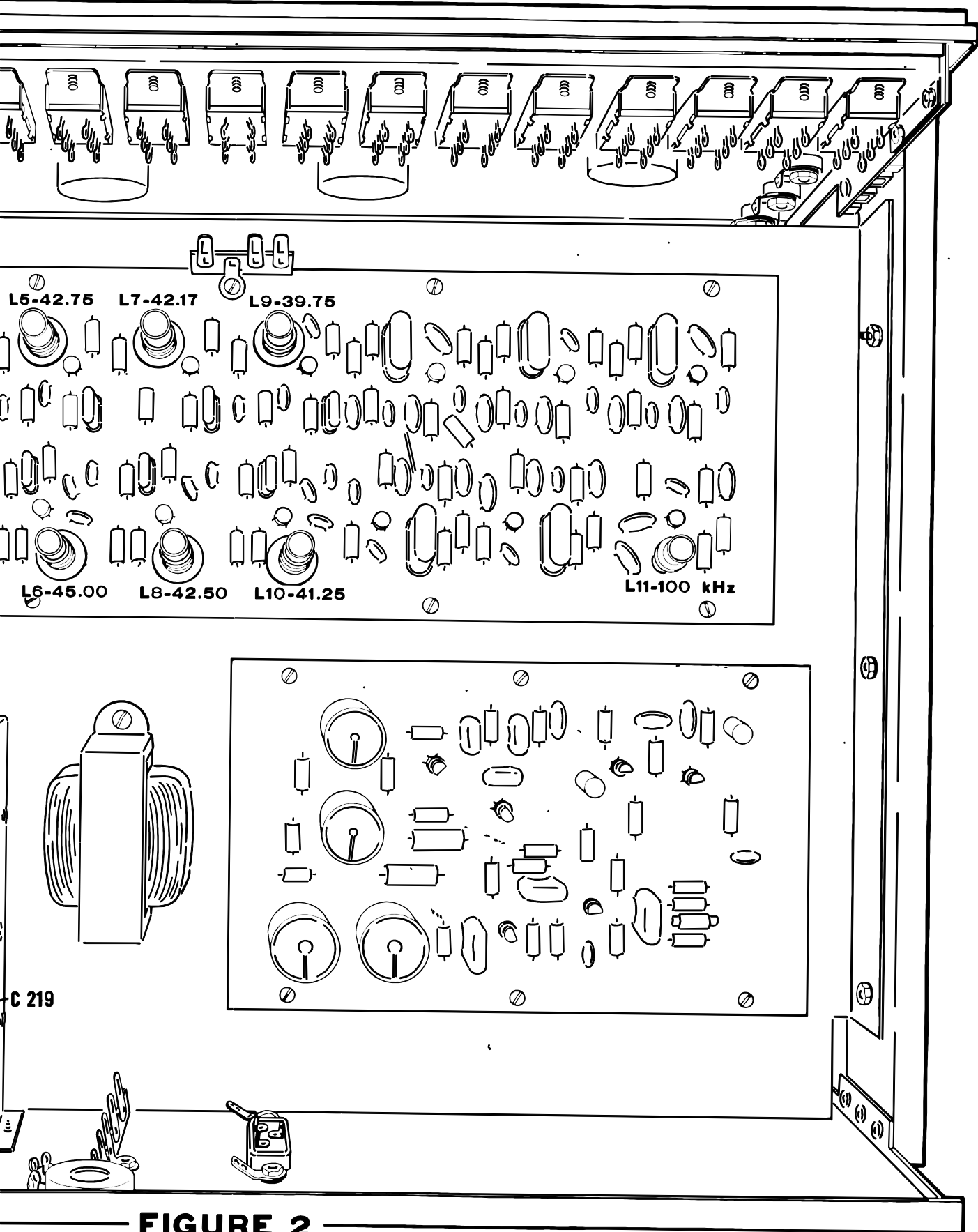

FIGURE 2



TESTS AND ADJUSTMENTS

Before you perform the Tests and Adjustments, carefully study the operation of each control and switch as described in Figure 1 (fold-out from this page).

EQUIPMENT REQUIRED

1. Voltmeter: High input impedance (11 M Ω).
2. Oscilloscope.
3. AM receiver.

INITIAL TESTS

If you do not obtain the proper results in any of the following tests, or if a malfunction occurs, refer to the "In Case of Difficulty" section on Page 85.

NOTE: Set the controls and switches as indicated below. Change the setting only as directed, then return the controls to the setting listed below. Disregard the controls and switches not listed.

- () Marker switches - OFF.
- () SWEEP RANGE - OFF.
- () BIAS - +.
- () BIAS 1 - fully CCW.
- (✓) BIAS 2 - fully CCW.
- () MARKER - fully CCW.
- (✓) TRACE - fully CCW.

- () Plug the female end of the power cord into the rear panel AC connector.
- () Plug the male end of the power cord into a 120 VAC source.
- () Place POWER switch in the ON position.

Refer to Figure 2 (fold-out from Page 56) for the adjustment locations and test point locations.

- () Connect a voltmeter from TP1 to ground. The voltage at this point should be ± 13.6 volts DC $\pm 10\%$. 14✓
- () Move the positive voltmeter lead to TP2. The voltage should be +20.0 volts $\pm 10\%$. 22
- () Move the positive voltmeter lead to TP3. The voltage should vary from approximately +3 volts to +15 volts as the SWEEP CENTER control is rotated to its fully clockwise position. ✓
- () Move the positive voltmeter lead to the BIAS 1 binding post. The voltage should vary from 0 to about +18 volts as the BIAS 1 control is rotated to its fully clockwise position. ✓
- () Move the positive voltmeter lead to the BIAS 2 binding post. The voltage should vary from 0 to about +18 volts as the BIAS 2 control is rotated to its fully clockwise position. ✓
- () Remove voltmeter leads and set voltmeter to read negative volts.

MOD. SWITCH
Provides 400 Hz modulation of the marker signal at the MARKER OUT connector. Marker pip will not appear on oscilloscope trace.

MARKER CONTROL
Adjusts the amplitude of the marker which appears at the Scope output.

TRACE CONTROL
Adjusts the amplitude of the demodulated signal that appears at the Scope output.

SWEEP WIDTH CONTROL
Adjusts the sweep oscillator from minimum to maximum sweep frequency deviation. Clockwise rotation increases, and counterclockwise rotation decreases the span of frequencies being swept.

SWEEP
Shifts freq. of the desired rotat. point

BIAS CONTROL
Rotation of the knob will adjust the amount of voltage that appears at the Bias binding posts.

BIAS
Selects positive or negative voltages applied to BIAS 1 and BIAS 2.

BIAS BINDING POSTS
Provides connections for source of variable bias voltages.

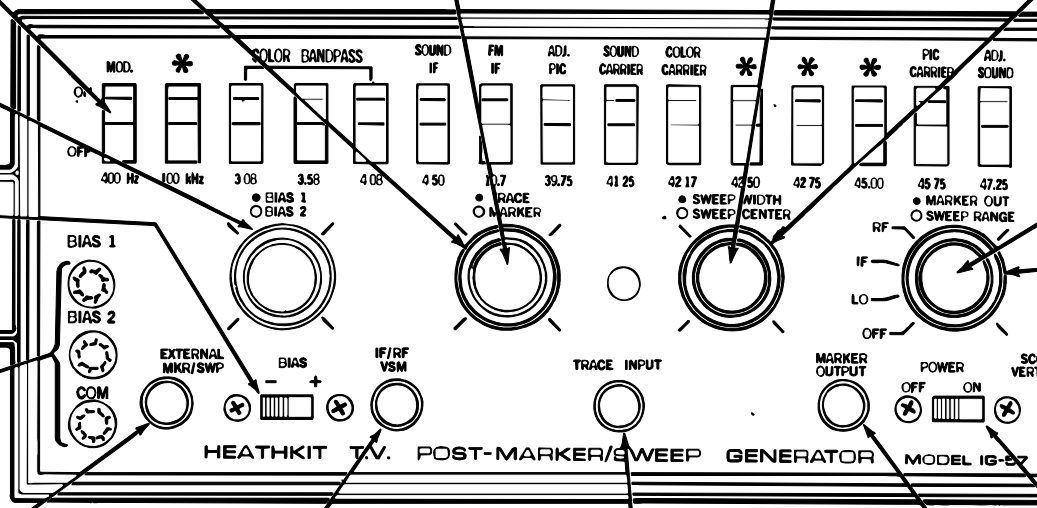

EXTERNAL MKR/SWP
Allows the injection of an external sweep signal to be mixed with the marker oscillator signal or allows the injection of external markers not provided by the Marker Generator.

IF/RF VSM
Provides video sweep modulated signal to be applied to the receiver under test.

TRACE INPUT
Demodulator Input connector allows the injection of a demodulated signal from the receiver under test.

MARKER OUTPUT
Provides a marker signal from the oscillator selected by the marker switches. A provides 400 Hz modulation if the marker frequency when MOD SWITCH is On.

BLANKING
Eliminates one trace and provides a base reference line in ON position. Switch must be in OFF position for proper adjustment of PHASE ADJUST control.

TRACE REVERSE
Reverses the oscilloscope trace to present frequency markers in proper sequence.

PHASE ADJUST
Adjusts phase of horizontal input signal so both traces on oscilloscope screen coincide.

SWEEP OUTPUT
Provides output signals from the sweep oscillators to the attenuator or directly to the set.

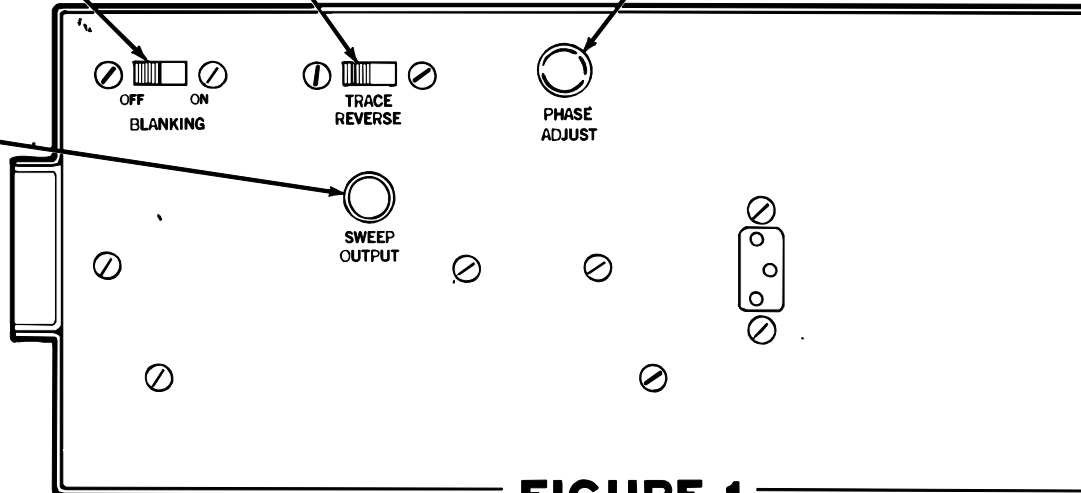

FIGURE 1

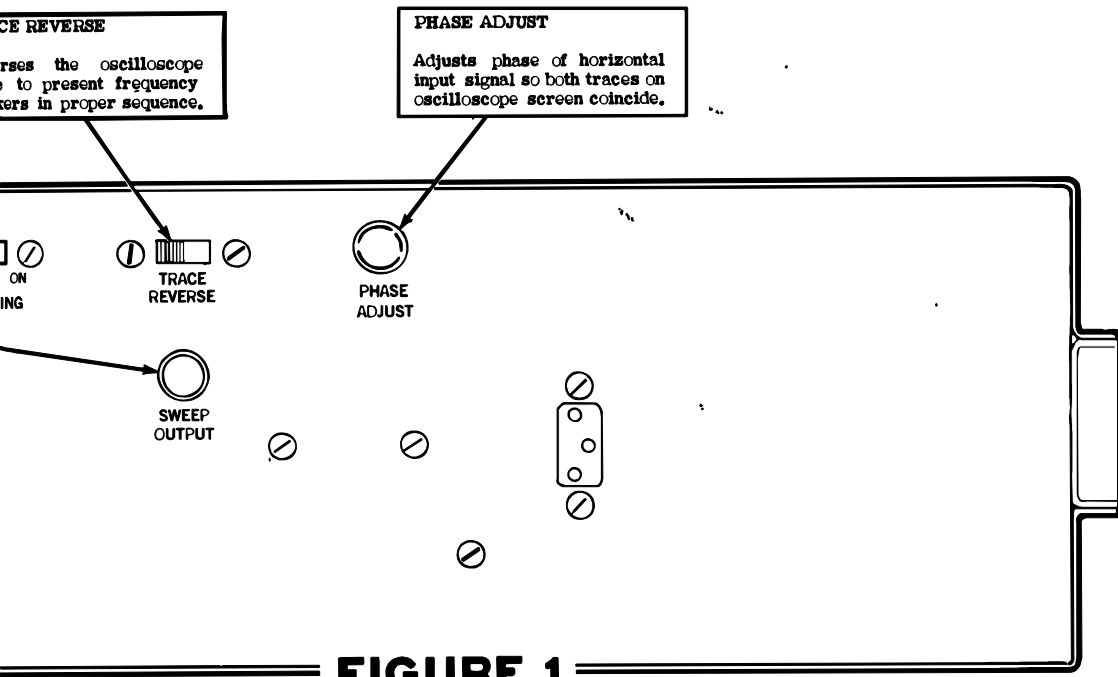
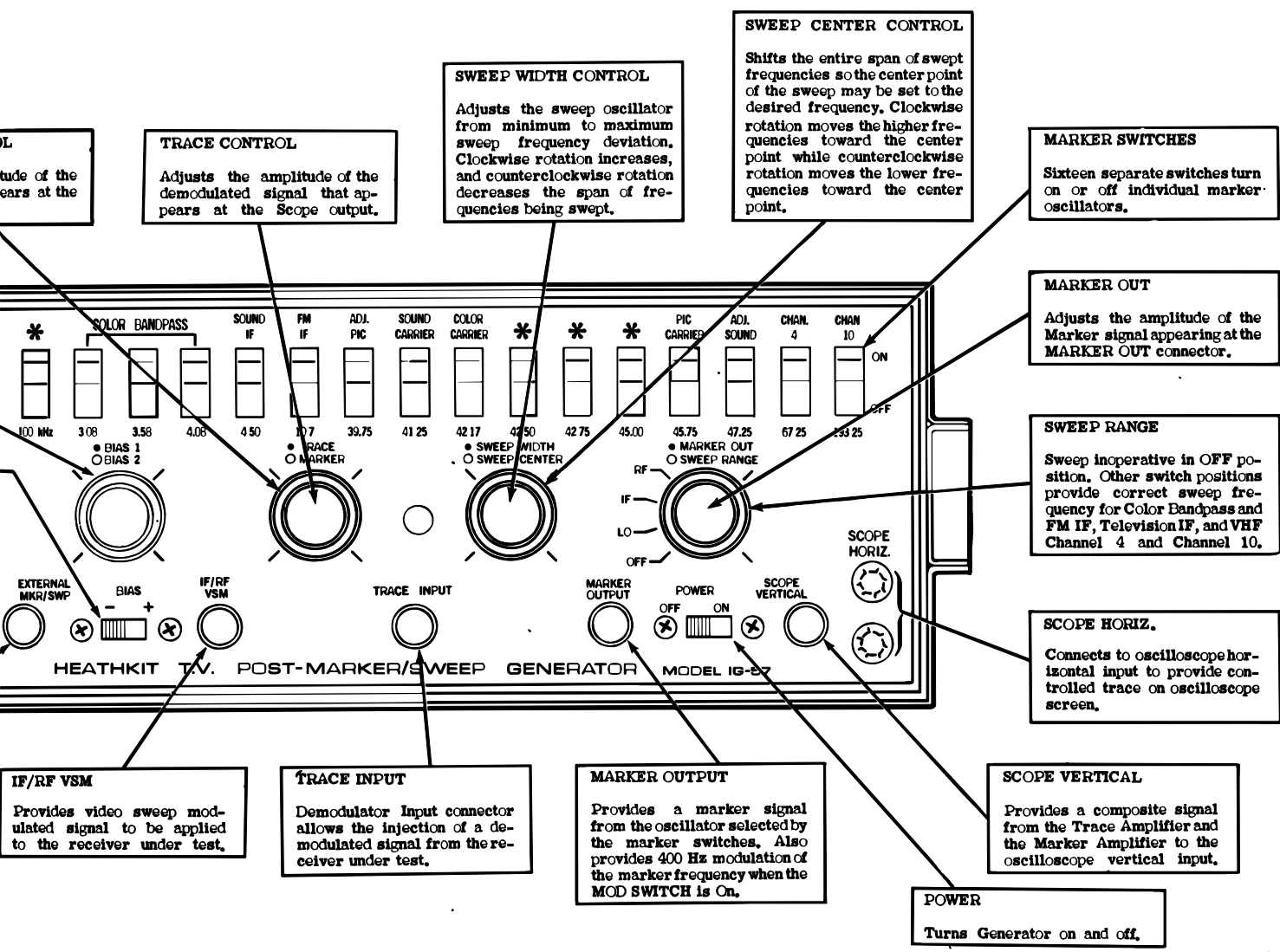

FIGURE 1

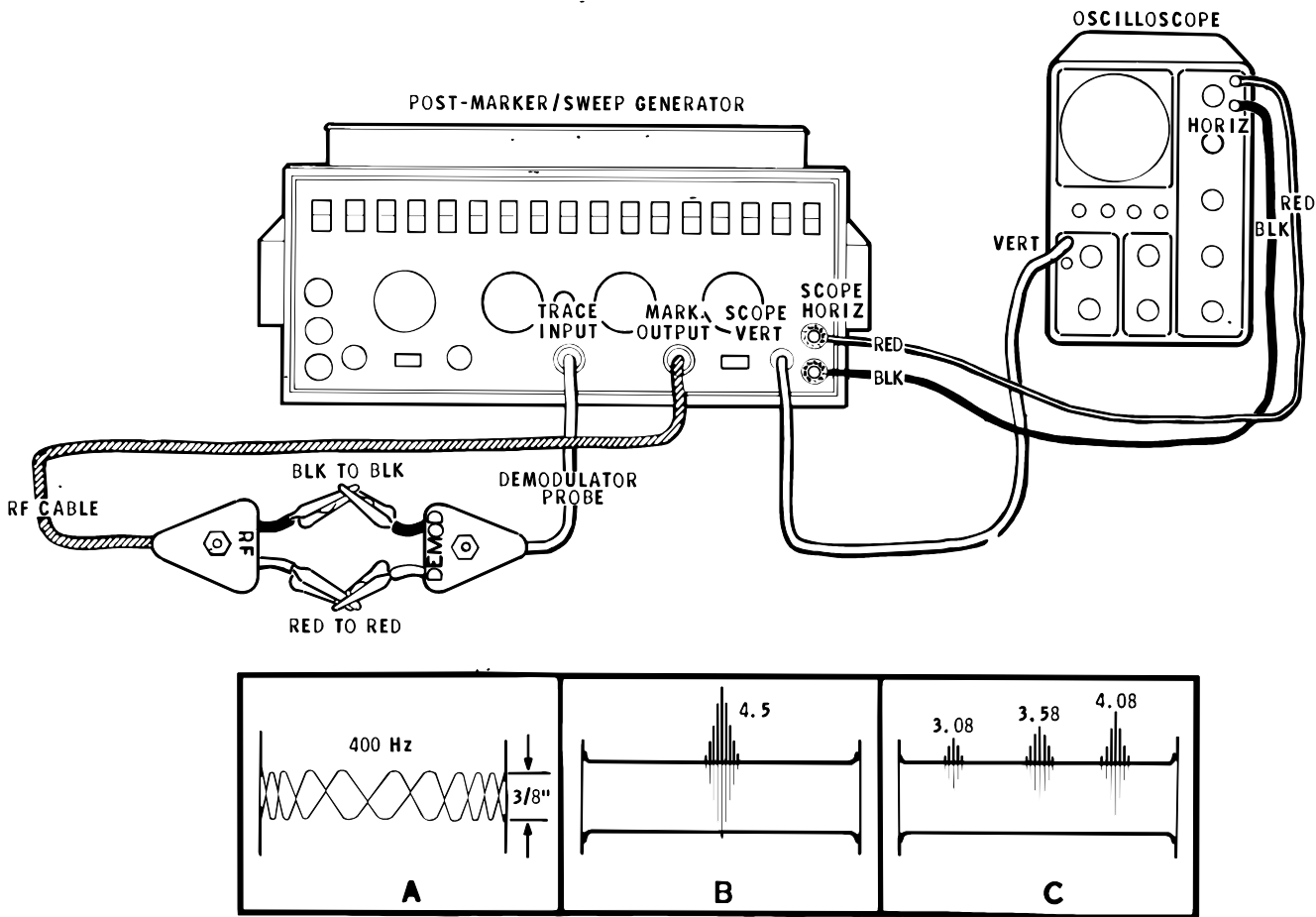

Figure 3 ADJUSTMENTS

- () Turn the **SWEEP WIDTH** control to its full counterclockwise position.
- () Adjust **PHASE ADJUST** control on rear panel until the trace has a rectangular waveform.
- () Readjust the **SWEEP WIDTH** to between the 1 and 2 o'clock position. This will cause the rectangular waveform to round slightly.
- () Turn on the 4.50 MHz marker.
- () Increase the **MARKER** control until the marker displays a 1" deflection.
- () Adjust the **SWEEP CENTER** control to center marker on trace. See Figure 3B.
- () Turn on the 4.08 marker. This marker will be about 1/3 the deflection of the 4.50 marker and should be slightly to the left of the 4.50 marker. If it is to the right, set the **TRACE REVERSE** to the other position. It is normal if marker pips, smaller than the regular markers appear.
- () Turn off the 4.50 marker.
- () Turn on the 3.58 and the 3.08 markers. Second harmonic markers, larger than the 3.58 and 3.08 markers, may appear on the right.
- () Adjust the **SWEEP CENTER** to center the markers as shown in Figure 3C. Turn the **MARKER** control counterclockwise for less ripple.

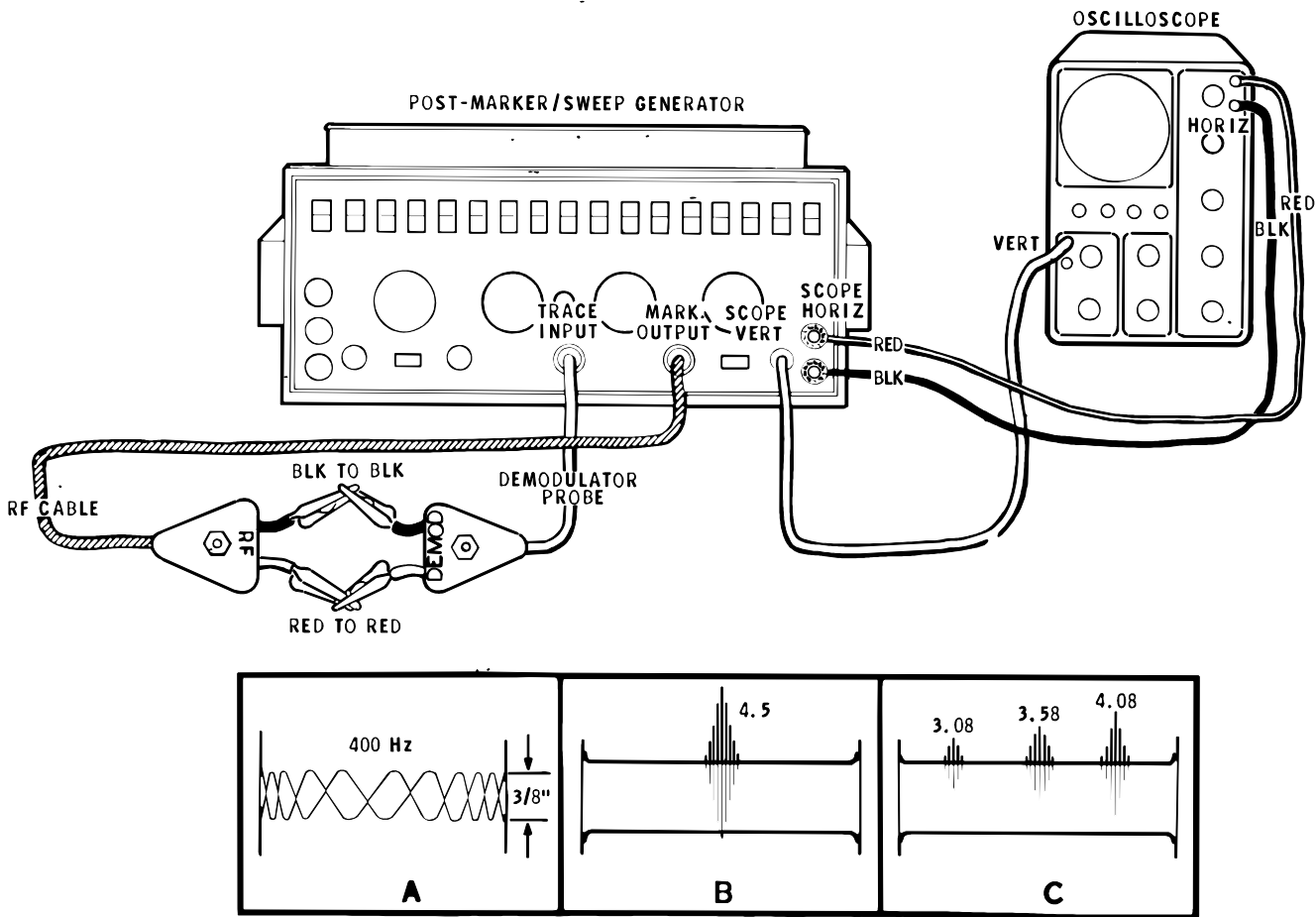

Figure 3 ADJUSTMENTS

- () Turn the SWEEP WIDTH control to its full counterclockwise position.
- () Adjust PHASE ADJUST control on rear panel until the trace has a rectangular waveform.
- () Readjust the SWEEP WIDTH to between the 1 and 2 o'clock position. This will cause the rectangular waveform to round slightly.
- () Turn on the 4.50 MHz marker.
- () Increase the MARKER control until the marker displays a 1" deflection.
- () Adjust the SWEEP CENTER control to center marker on trace. See Figure 3B.
- () Turn on the 4.08 marker. This marker will be about 1/3 the deflection of the 4.50 marker and should be slightly to the left of the 4.50 marker. If it is to the right, set the TRACE REVERSE to the other position. It is normal if marker pips, smaller than the regular markers appear.
- () Turn off the 4.50 marker.
- () Turn on the 3.58 and the 3.08 markers. Second harmonic markers, larger than the 3.58 and 3.08 markers, may appear on the right.
- () Adjust the SWEEP CENTER to center the markers as shown in Figure 3C. Turn the MARKER control counterclockwise for less ripple.

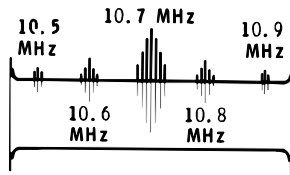

Figure 4

Refer to Figure 4 for the following steps.

- () Turn off the markers.
- () Set **MARKER** to the center of rotation.
- () Turn on the 10.7 marker. This marker should appear at the right side of the trace.
- () Adjust the **SWEEP CENTER** control to center the 10.7 marker.
- () Turn the **SWEEP WIDTH** control (turn counterclockwise) to its 9 o'clock position.
- () Turn on the 100 kHz marker. At least two smaller markers should appear on each side of the 10.7 marker.
- () Increase the **MARKER** and adjust the **SWEEP WIDTH** to display these markers more clearly.
- () Turn off the markers.
- () Turn the **SWEEP WIDTH** control fully clockwise.
- () Turn the **MARKER** control to its 9 o'clock position.
- () Set the **SWEEP RANGE** to **IF**.
- () Adjust the **SWEEP CENTER** control for +12.0 volts at TP3. Leave the voltmeter connected to be sure +12.0 volts are maintained.
- () Turn on the 42.75 marker.
- () Adjust **C219** to center the marker on the trace.
- () Set the blanking switch to **OFF**.

NOTE: Two separate markers will be seen close together (they may be superimposed). See Figure 5A.

- () Adjust the **PHASE ADJUST** control until both markers are superimposed (one on top of the other) as in Figure 5B.
- () Set the **BLANKING** switch to **ON** position.
- () Turn on the 39.75 and 47.25 markers.
- () Turn the 42.75 marker off.
- () Adjust **C219** and the **SWEEP WIDTH** control so the markers are 1/4" from each end. See Figure 5D. Keep the TP3 voltage at +12.0.
- () Turn on the markers shown in Figure 5F. Note that some markers will have different amplitudes.
- () Refer to Figure 2 for coil locations for each marker frequency.
- () Adjust the corresponding coil clockwise to decrease any marker that is larger than the average size.
- () Adjust the corresponding coil counterclockwise to increase any marker that is smaller than the average size.

NOTE: If a marker is turned down too far, the oscillator may not start when switched on. If any marker does not start when switched on and off, readjust the coil slug slightly counterclockwise.

- () Turn off the 41.25, 42.17, 45.00, and 45.75 markers.
- () Turn on the 42.50 and 42.75 and check the markers' amplitude.
- () Turn off all of the markers and set the **SWEEP RANGE** switch to the **RF** position.
- () Adjust the **SWEEP CENTER** control until the voltmeter reads +12.0 volts DC at TP3.
- () Turn on the 67.25 MHz marker switch. Then refer to Figure 2 and adjust trimmer capacitor **C223** until the 67.25 MHz marker appears and is centered on the trace.
- () Turn off the 67.25 MHz marker switch.



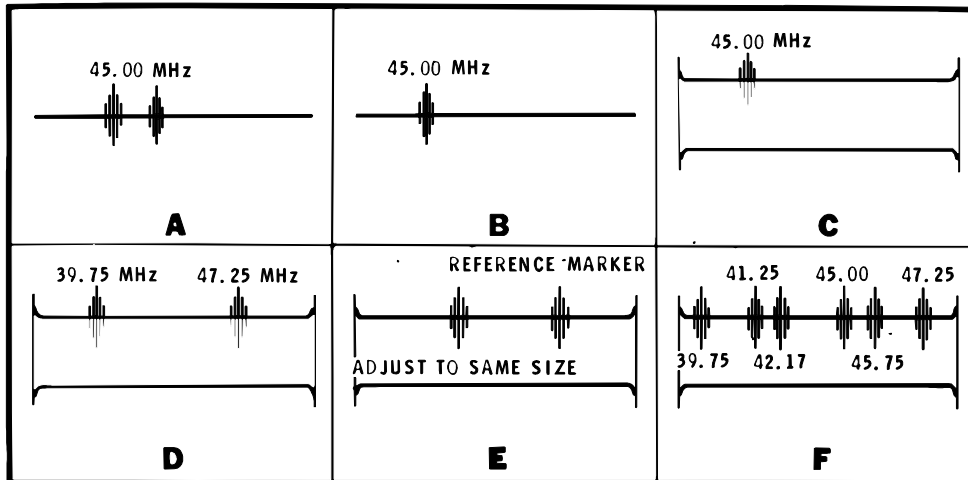

Figure 5

- () Again connect the positive lead of your voltmeter to TP3 and adjust the SWEEP CENTER control until the meter reads 10.2 volts DC.
- () Turn the MARKER control to the center of its rotation (12 o'clock position).
- () Turn the SWEEP WIDTH control to the center of its rotation (12 o'clock position).
- () Turn on the 193.25 MHz marker switch and adjust the slug in coil L2 for the highest amplitude marker with the least trace distortion. To check that the 193.25 MHz marker is at the correct frequency, turn off the 193.25 MHz marker switch and turn on the 10.7 MHz marker switch. Another marker should appear very close to where the 193.25 MHz marker was. Do not readjust trimmer capacitor C223.
- () Turn off all markers.
- () Set the SWEEP RANGE to the off position.
- () Turn on an AM receiver and tune it to a station that is a multiple of 100 kHz (700, 900, or 1200 kHz, etc.), or to station WWV.
- () Connect the RF cable to the MARKER OUT connector and place the RF cable pod near the built-in antenna (or antenna terminal) of the AM receiver.

- () Turn on the 100 kHz marker switch and set the MARKER OUT control fully clockwise.

NOTE: In the next step, the tone of the whistle will decrease as the coil slug approaches the "zero-beat" or null point. This tone will again increase if the coil slug is turned too far. Do not turn the coil slug more than one turn in either direction from the original preset position.

- () Adjust coil L11 for a zero beat in the AM radio. The tone in the AM radio should decrease and increase as the coil is adjusted. A zero beat should occur at the point where the tone from the AM radio is the lowest or no tone can be heard.

NOTE: If a beat note cannot be heard, it may be necessary to make a coil from a piece of insulated wire. The coil should have at least four turns of wire and should be about 2" in diameter. The coil should then be placed around or near the AM receiver rod antenna, with the clips of the RF cable pod connected to the bared ends of the coil.

- () Turn off the 100 kHz marker switch and disconnect the RF cable from the AM radio antenna.

This completes the Tests and Adjustments.



BLANK PAGE



FINAL ASSEMBLY

- () Remove the tape at each end of both handles.
- () Refer to Detail 34A and place a handle, grained side out, over the spacer studs. Place an end cap in position at each end of the siderails and secure each cap with a 6-32 decorative head screw. Use a coin to tighten the screws.
- () In the same manner, install the other handle and two end caps on the other end of the Generator.
- () Locate the shield cover (#205-591) and secure it to the top of the sweep shield with #6 x 3/8" sheet metal screws at the five locations in the sweep shield.

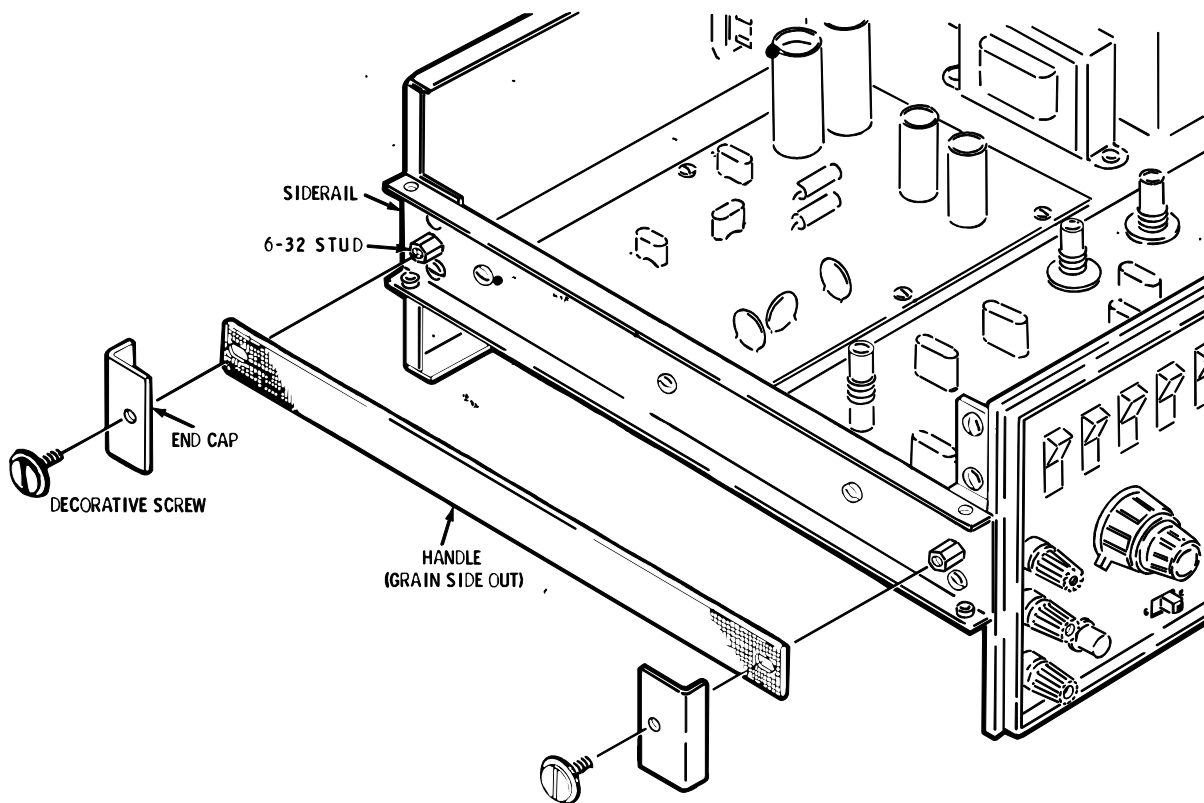

Detail 34A

Refer to Pictorial 34 for the following steps.

- () Place one of the cabinet shells over the top of the Generator with the sloping edge toward the front panel. Secure the shell with 6-32 x 1/4" phillips head screws at the four locations in the flanges of the shell. Then turn the Generator over.
- () Locate the shield plate (#205-727) and place it over the opening in the chassis, as shown in Detail 34B. Position it so the notch in one edge is toward the center of the chassis and the large holes in the plate are around the two screws that secure the sweep assembly to the chassis.
- () Insert the 1 k Ω resistor through the hole.
- () Secure the plate with #6 x 3/8" sheet metal screws at the three open locations.
- () Connect the 1 k Ω resistor lead to lug 2 of the terminal strip (S-4).
- () Place the remaining cabinet shell over the bottom of the Generator with the sloping edge toward the front panel. Secure the shell with 6-32 x 1/4" phillips head screws as shown.
- () Refer to Detail 34C and install a plastic foot near each corner on the bottom cabinet shell. Remove the paper backing; then press the foot onto the cabinet shell in the position shown. A plastic foot can be moved, if necessary, up to one-half hour after the foot was installed. After this time, the adhesive permanently bonds the foot to the cabinet shell.

This completes the assembly of your TV Post-Marker/Sweep Generator.

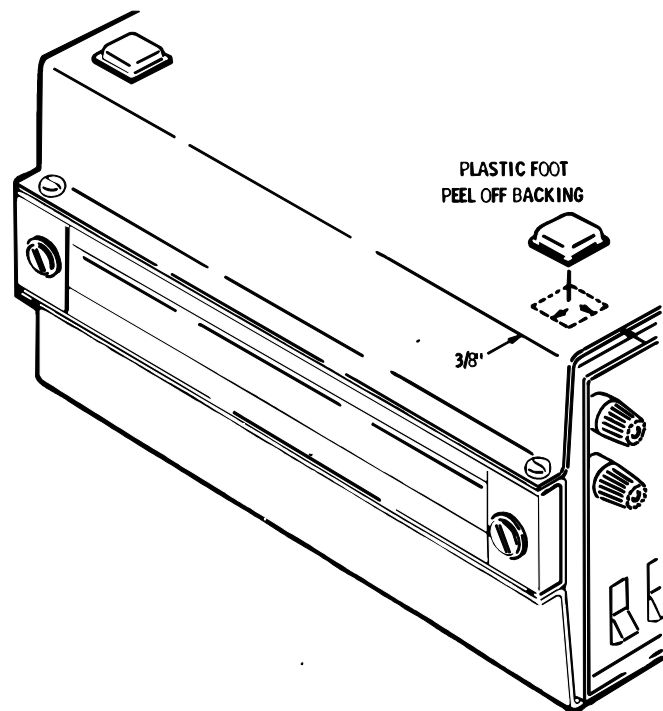
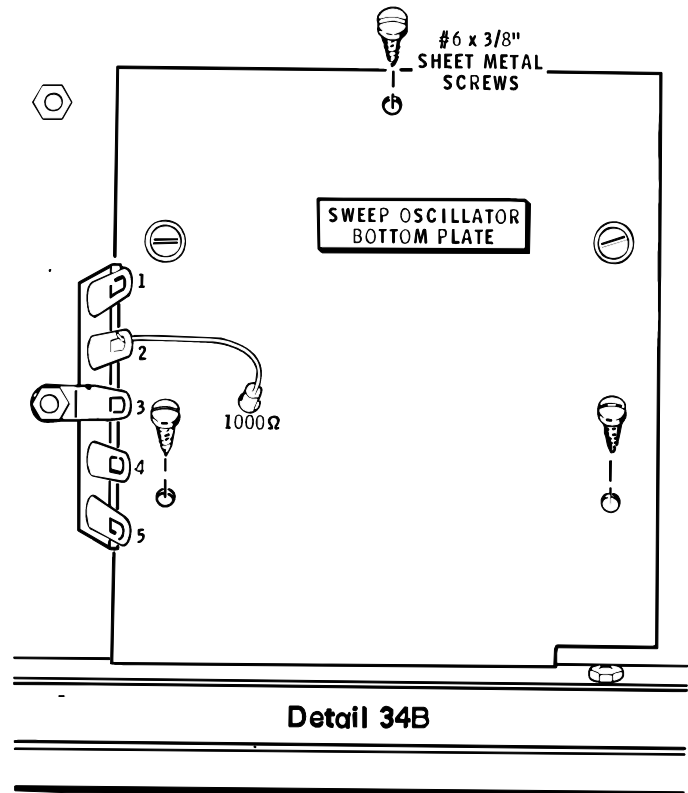

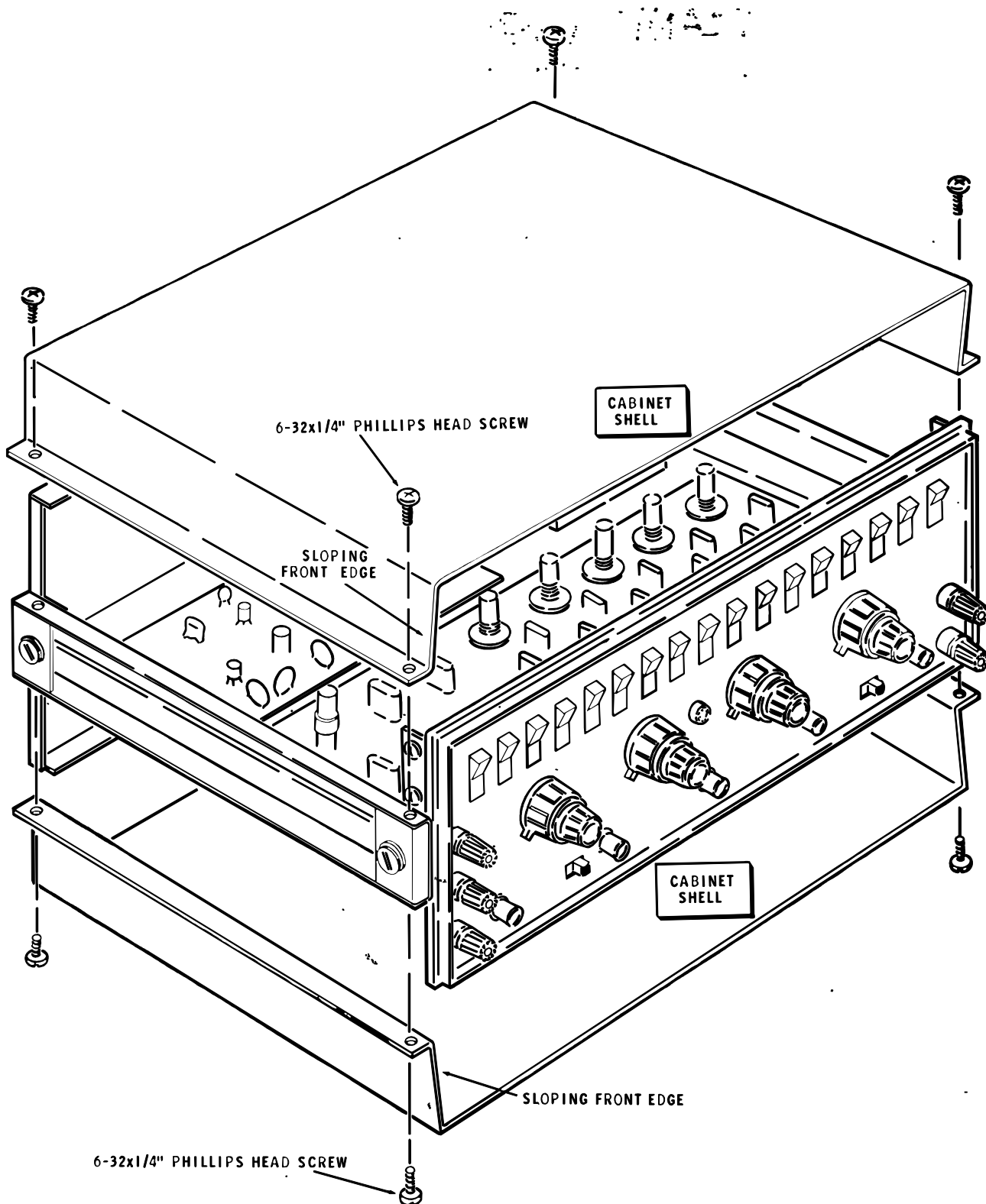

PICTORIAL 34



BLANK PAGE

APPLICATIONS

This section of the Manual provides a general description of how your TV Post-Marker/Sweep Generator can be used to align TV IF, TV trap, VHF tuner, color bandpass, FM tuner, FM IF,

and FM tuner tracking. **CAUTION:** Always follow the manufacturer's instructions when you perform the alignment.

PRECAUTIONS

Listed below are several hints and precautions that are useful and necessary when aligning a TV receiver.

1. Disable the high voltage applied to the picture tube. Do this by removing the plate cap from the horizontal output tube. Then connect the load specified by the manufacturer from B+ to ground. This will apply the proper load to the low voltage power supply. Do not allow the disconnected plate cap to contact the chassis.
2. Remove the horizontal oscillator tube to prevent horizontal pulses from appearing on the oscilloscope trace.
3. Remove the vertical oscillator tube to prevent vertical pulses from appearing on the oscilloscope trace.
4. Do not substitute other cables for those supplied with the Generator.
5. Do not place the Generator or oscilloscope leads over the IF board, IF coils, and tubes because of possible detuning or oscillation in the section under test.
6. Check and be sure that there are no ground loops between the pieces of equipment. This is easily checked by observing the trace on the oscilloscope and touching each piece of equipment. If the trace moves or changes shape, check all ground connections. It may be necessary to ground all of the cables at one common point.
7. Bias as specified by the set manufacturer should be applied to the receiver under test.
8. More accurate trap adjustments can be obtained by reducing the bias on the IF. Take care not to overload the IF circuit by the application of too much signal from the Generator.
9. Set the oscilloscope vertical gain control near its most sensitive position and keep the Generator output as low as possible. This will prevent overloading the IF amplifiers with a signal which may produce an improper curve and result in misalignment of the IF circuits.

10. When you adjust a transformer or coil that has two slugs, each slug may have two positions that appear to tune to the correct frequency. The position farthest away from the center of the coil form is correct; the position nearest the center of the coil form is incorrect due to coupling from one coil to the other through the slugs. You may have to turn both slugs out to the ends of the coil form and then turn the slugs, each slug a little at a time, in to the correct points.

11. Television receiver alignment requires greater skill and understanding on the part of the technician than does any other service function. It is important that the technician be able to recognize the symptoms of a misaligned receiver. The order in which the various sections of a television receiver are aligned may differ between receivers of the same manufacturer. Therefore, the alignment procedure for the specific receiver under test should be followed in detail.

TV ALIGNMENT

IF ALIGNMENT

NOTE: Follow the manufacturer's instructions very carefully. If the alignment instructions do not indicate a specific setting for the channel selector, turn the selector to the highest unused VHF channel. In very strong signal areas, it may be necessary to disable the VHF oscillator to prevent station interference during alignment. Be sure all alignment equipment and the TV set are at normal operating temperature.

Refer to Figure 6 (fold-out from this page) for the following steps.

- () Connect the Generator, Attenuator, and Oscilloscope together and connect the Generator and Attenuator to the TV set as shown.

NOTE: If bias voltage is called for, connect the bias leads to the proper point on the TV set. Connect a voltmeter across the BIAS binding posts and adjust this voltage to the value specified by the manufacturer. Either positive or negative voltage may be applied by setting the BIAS switch.

- () Place both of the attenuator 20 dB rocker switches to the IN position for 40 dB of attenuation.
- () Set the oscilloscope vertical attenuator and vertical gain control to near maximum sensitivity.
- () Turn the SWEEP RANGE switch to the IF position. Turn on the TV set and allow it to reach normal operating temperature.

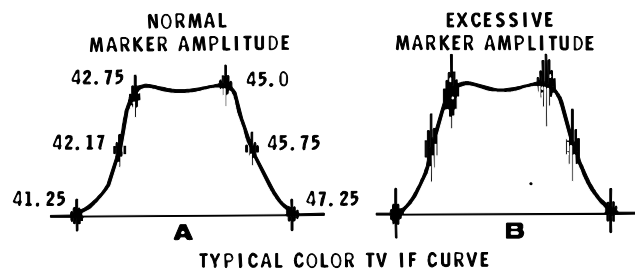

Figure 7

NOTE: The trace shown in Figure 7A is a typical overall IF waveform for most TV set IF circuits. You will not obtain this waveform if the IF circuits in the Color TV set you are testing are out of adjustment. However, you should obtain a trace with the 42.17, 42.75, 45.00, and 45.75 MHz markers in the left-to-right sequence as shown in the Figure. Use the TRACE-REVERSE switch if necessary.

- () Turn on the 45.00 MHz marker and place the BLANKING switch in the OFF position.
- () Adjust the SWEEP CENTER control and locate this marker.
- () Adjust the PHASE control and superimpose both markers; then place the BLANKING switch in the ON position.
- () Turn on the required marker switches. If the TV set IF circuits are correctly aligned, the markers should appear as shown in Figure 7A.

NOTE: If the IF circuits are far out of adjustment, you may have to inject the signal into the last IF stage; then work toward the IF input. The output from the generator (TRACE and MARKER controls) should be increased when



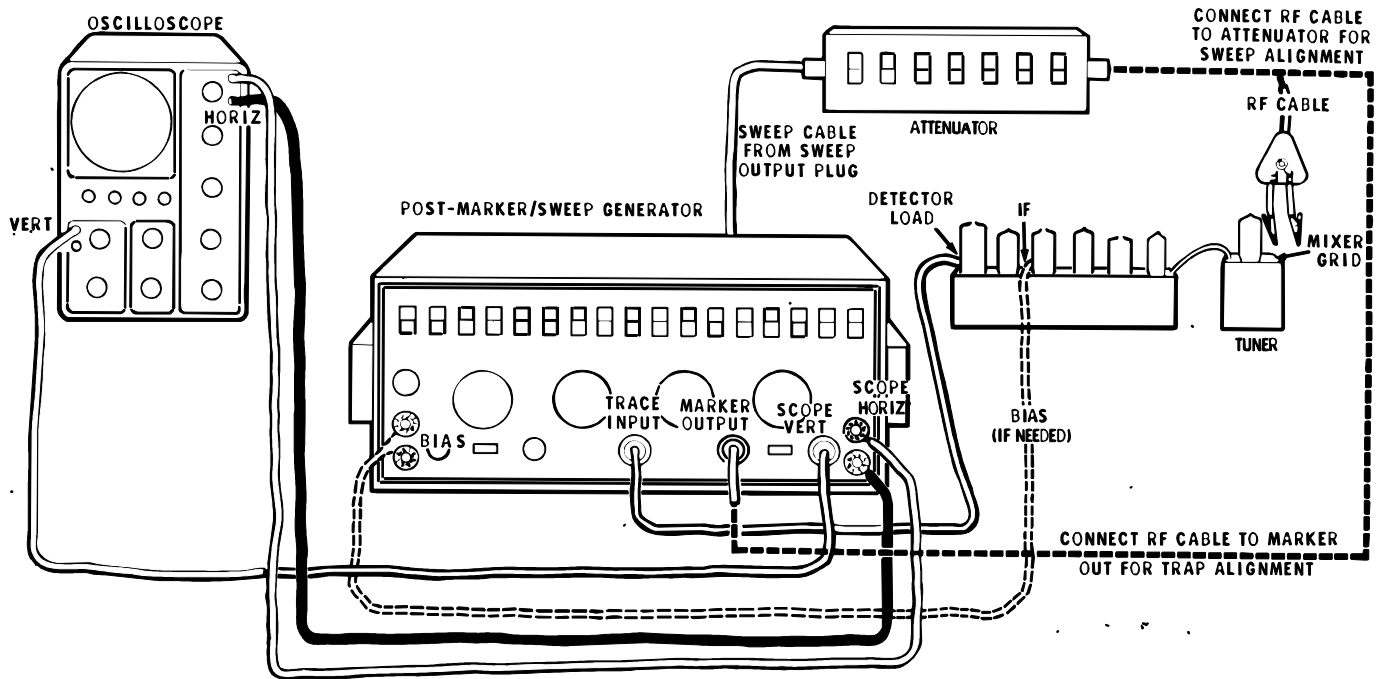

FIGURE 6

CONNECTIONS FOR IF SWEEP AND TRAP ALIGNMENT

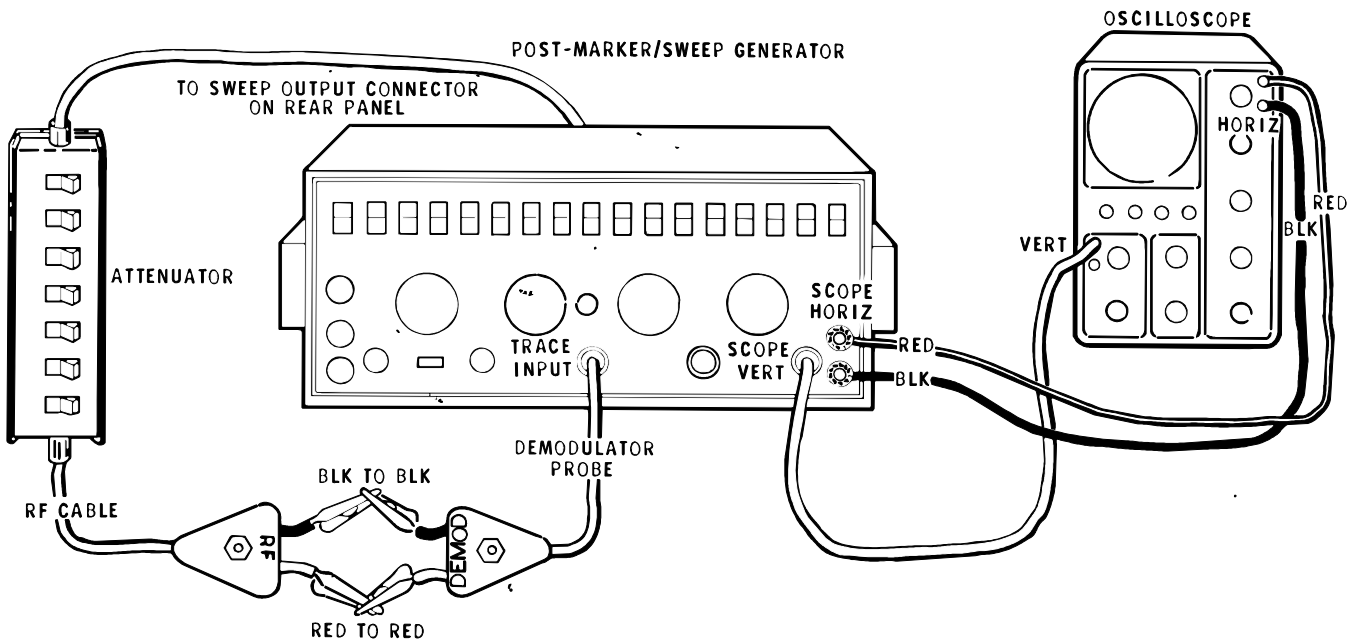

FIGURE 12

CONNECTIONS FOR OSCILLOSCOPE dB CALIBRATION

the signal is injected into the last IF stage because there will be very little IF amplification. The output must be decreased as the signal injection point is moved back toward the input of the IF circuits. An overall IF check and adjustment should be performed after the stage-by-stage adjustments have been made.

INCORRECT PHASE ADJUSTMENT



Figure 8

Figures 7 through 9 show normal and incorrect IF curves. Figure 7A shows a normal IF curve with proper size markers. Figure 7B shows a normal IF curve with excessive marker amplitude. Figure 8 shows an IF curve with the phase adjusted incorrectly. Figure 9 shows only markers with the TRACE control turned fully counter-clockwise.



Figure 9

Some set manufacturers specify the position of the marker frequencies as so many "dB down," or as a percentage of full trace size. Figure 10 shows a typical color TV IF response curve with markers indicated by both dB and percentage.

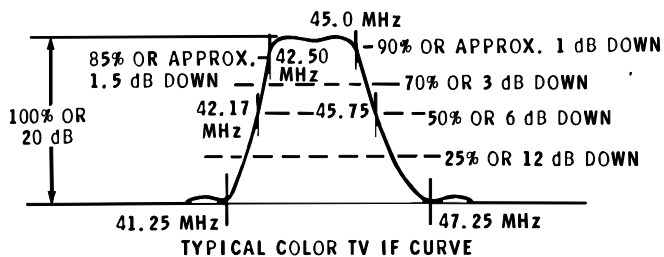

Figure 10

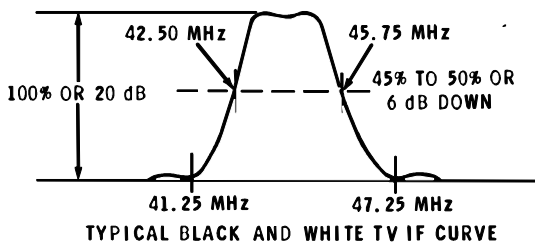

Figure 11A

Figure 11A shows a typical black and white TV IF response curve. Note that the IF bandwidth which is usually specified as the point at which the response is 6 dB down from maximum, is greater for color TV than it is for black and white TV.

For the color set, the 6 dB points are at 42.17 MHz and 45.75 MHz; the difference being 3.58 MHz, which is the IF bandwidth. For the black and white set, the 6 dB points are 42.50 MHz, and 45.75 MHz; the difference being 3.25 MHz, which is the black and white IF bandwidth (for a high quality set).

Proper bandwidth is necessary for correct picture detail. A too-narrow bandwidth will cause picture smear and loss of detail. A too wide bandwidth will produce a grainy, herring-bone picture with possible ringing and a greater chance of adjacent channel interference.

NOTE: If you align the IF circuits of a black and white TV set to the same bandwidth as the IF circuits of a color TV set, the picture will be distorted due to the greater bandwidth and the lack of sufficient trapping of the 4.5 MHz sound signals.

Oscilloscope Calibration

Some TV set manufacturers indicate that the markers should be "so many dB down" on the bandpass curve of the tuner or IF circuit being checked or aligned. To properly align the tuner or IF system under this condition, you must be able to determine where these specified dB points are located on the waveform displayed on your oscilloscope.

The waveform used for alignment purposes is normally taken from the output of the detector (a nonlinear device) on the receiver. As an example: assume that the signal applied to the input of the circuit produces a vertical deflection on the oscilloscope of two inches. If the input signal is attenuated 6 dB (50%), the vertical deflection produced on the oscilloscope will be less than one inch (50% of the original two-inch deflection) due to the nonlinear characteristic of the detector. Therefore, your oscilloscope should be calibrated to show the true location of the specified dB points on the detected waveform. You can calibrate your oscilloscope by performing the following procedure.

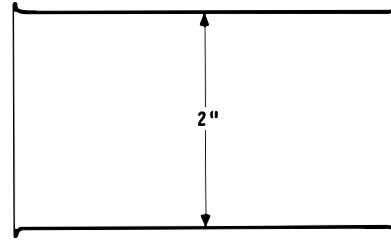

Figure 11B

- () Set the vertical gain and the vertical attenuation controls of the oscilloscope near the maximum gain positions. Do not change the positions of these controls during this calibration procedure.
- () Refer to Figure 12 (fold-out from Page 68) and connect the Oscilloscope, Generator, and Attenuator together as shown.
- () Place all of the Generator Marker switches and the Attenuator rocker switches in the off position.
- () Turn the SWEEP WIDTH, SWEEP CENTER, and the MARKER controls fully counter-clockwise.
- () Set the SWEEP RANGE switch to the IF position and turn on the Generator and Oscilloscope.
- () Refer to Figure 11B and adjust the Generator's Trace control and the Oscilloscope's vertical positioning control until the waveform fills the area between the bottom and top lines on the screen graticule. NOTE: If your oscilloscope does not have a graticule or lines on the screen, use a grease pencil and mark a line on the screen at the top and bottom of the waveform.
- () Place the 1 dB rocker switch on the Attenuator to the IN position.
- () Use the Oscilloscope vertical positioning control to position the bottom of the waveform on the bottom line on the graticule or the mark you made on the screen.
- () Now mark the new position of the top of the waveform. This will indicate the "1 dB down" point (90% of original waveform).
- () Place the Attenuator 1 dB rocker switch to the off position and the 3 dB rocker switch to the IN position.
- () Use the Oscilloscope vertical positioning control to again position the bottom of the waveform on the bottom line of the graticule or the mark on the screen.
- () Again mark the new position of the top of the waveform. This will indicate the "3 dB down" point (70% of original waveform).
- () Place the Attenuator 3 dB rocker switch to the off position and the 6 dB rocker switch to the IN position.
- () Use the Oscilloscope vertical positioning control to again position the bottom of the waveform on the bottom line of the graticule or the mark on the screen.
- () Mark the new position of the top of the waveform. This will be the "6 dB down" point (50% of original waveform).
- () Mark these points on the graticule or screen of the oscilloscope. They will be the 1 dB down (90%), 3 dB down (70%) and 6 dB down (50%) points of a waveform with a vertical deflection of two inches of peak-to-peak.

Use these points when the set manufacturer's instructions show the marker position in dB. This completes the Oscilloscope Calibration.





TRAP ALIGNMENT

Television trap alignment includes adjustments of the sound trap and adjacent channel traps for separation of the video and sound signals. Figure 6 shows how the Generator and an oscilloscope are connected to the IF strip and tuner of a TV set for the alignment procedure. The sound and adjacent channel traps are adjusted to the frequencies specified by the manufacturer for the TV set being aligned. When aligning the traps, adjust the AGC bias according to the manufacturer's instructions. The modulated RF output from the Generator should be kept as low as possible and still produce an adequate pattern on the oscilloscope screen.

- () Turn the SWEEP RANGE switch to the OFF position.
- () Turn on the 41.25 MHz marker switch and the MOD switch.
- () Adjust the sound trap for a minimum amplitude of the oscilloscope pattern. If necessary, reduce the IF bias to increase the IF gain. NOTE: As the IF gain is increased, the trap adjustment becomes more critical.
- () Again adjust the sound trap for minimum amplitude of the oscilloscope pattern.
- () Repeat the preceding three steps until the sound trap is properly aligned; then turn off the 41.25 MHz marker switch.
- () Turn on the 47.25 MHz marker. Then follow the same procedure to properly align the adjacent channel sound trap.

NOTE: If the TV set has a 39.75 MHz adjacent picture trap, align it according to the manufacturer's instructions.

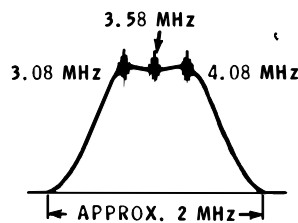

A

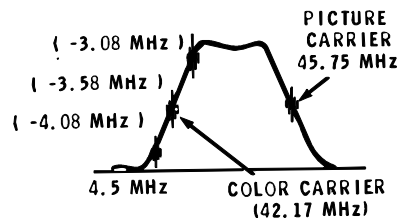

B

Figure 13

- () Recheck the overall IF alignment for proper marker placement and bandwidth.

COLOR BANDPASS ALIGNMENT

NOTE: Figure 13A shows a representative curve for the output stage of a color bandpass circuit.

Figure 13B shows the proper relationship between the picture carrier, color carrier and the color bandpass markers as they would appear on an overall IF curve.

Perform the following steps to align the color bandpass coils.

- () Connect the Generator and oscilloscope to the TV set according to the manufacturer's instructions.
- () Turn the SWEEP RANGE switch to the LO position.
- () Turn on the 3.08, 3.58, and 4.08 MHz Marker switches.

NOTE: It may be necessary to disable the TV set's 3.58 MHz color oscillator to prevent trace interference.

- () Adjust the color bandpass coils for the response curve shown in the manufacturer's instructions.



COLOR BANDPASS ALIGNMENT - VSM

More manufacturers are requiring a sweep-modulated video carrier frequency to properly align the overall color frequency response. This method provides a closer match between the IF and color circuits.

This method requires the video IF and last color bandpass transformer to be aligned first. See the previous sections.

The generator output signal will consist of a video carrier and two sidebands. As this signal passes through the IF and video detector diode, the upper sideband and carrier frequency are removed. The lower sideband is demodulated and applied to the color bandpass amplifiers. The response is observed at the output of the color bandpass transformer.

For "IF VSM Alignment" a 45.75 MHz carrier is modulated by a low frequency (3-5 MHz) sweep signal and inserted at the tuner mixer grid.

For "RF VSM Alignment" a 67.25 MHz carrier is modulated by a low frequency (3-5 MHz) sweep signal, and inserted at the VHF antenna terminals.

IF VSM Alignment

- () Turn the TV VHF channel selector to the highest unused channel, if the manufacturer's instructions do not indicate a specific setting.
- () Be sure the antenna is disconnected. NOTE: The video IF and last color bandpass transformer must be aligned before the following steps are performed.
- () Connect the equipment as shown in Figure 14 (fold-out from this page).
- () Turn the SWEEP RANGE control to the LO position.
- () Turn on the 45.75 MHz marker.
- () Turn the TINT and COLOR controls to the center of rotation. The trace shown in the figure below is a typical overall color IF waveform.

NOTE: If the 3.58 MHz oscillator in the TV set causes distortion of the trace, it may be necessary to disable the oscillator. Use the lowest possible signal from the Generator that gives a viewable trace. Some receivers, when properly set up, will exhibit more noise on the trace than others.

- () Adjust the input color bandpass coil for the response shown in Figure 14A.

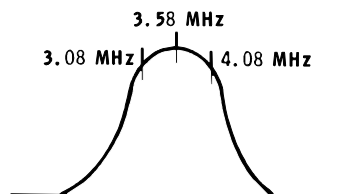

Figure 14A
OVERALL COLOR RESPONSE

This completes the "Color Bandpass Alignment." Disconnect the RF and Demodulator cables from the TV set.

RF VSM Alignment

FINE TUNING ADJUSTMENT

NOTE: Before RF VSM alignment can be performed, it is very important to correctly set the fine tuning. An incorrect setting will result in an incorrect alignment. The video IF should also be aligned with special attention given to the trap alignment.

- () Connect the equipment as shown in Figure 15 (fold-out from this page).
- () Connect the clip-lead cable through a 47 k Ω resistor to the output of the video detector.
- () Connect the RF cable from the attenuator to the VHF antenna terminals through the matching pad as shown.
- () Connect the bias as required.



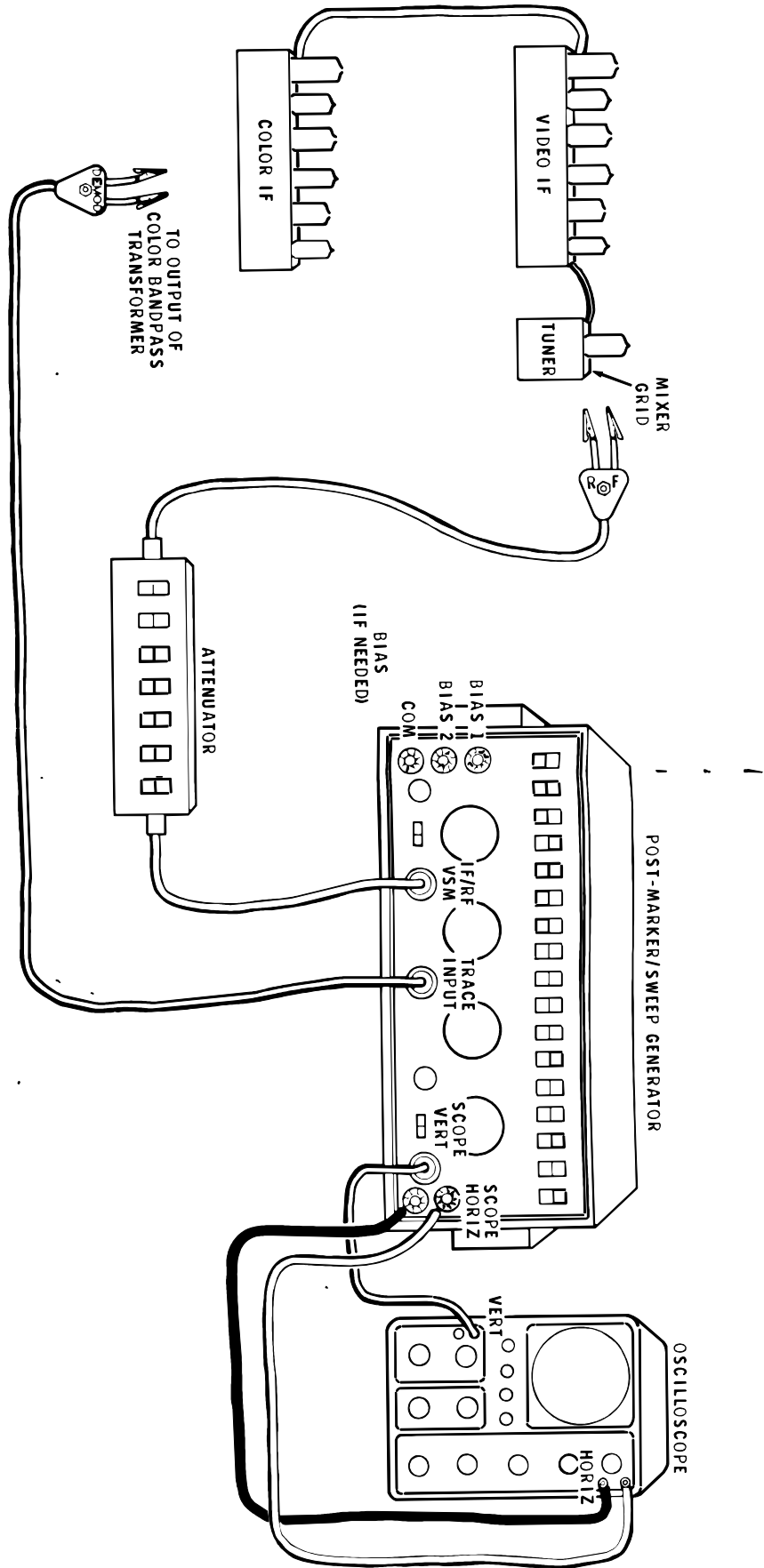

FIGURE 14
CONNECTIONS FOR IF-VSM ALIGNMENT

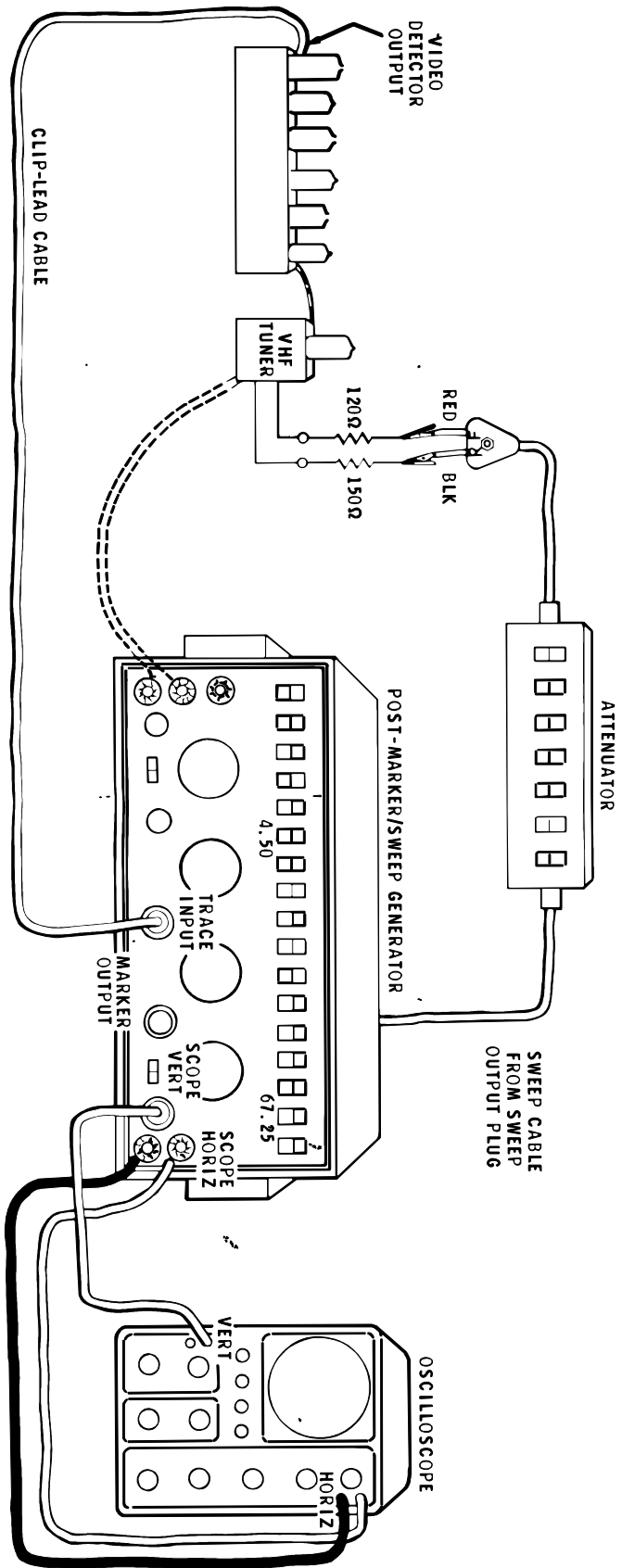

FIGURE 15
CONNECTIONS FOR SETTING THE FINE-TUNING FOR RF-VSM ALIGNMENT

- () Turn on the 67.25 and 4.50 markers.
- () Set VHF channel selector to channel 4. (Turn off AFT.)
- () Set the SWEEP RANGE control to the RF position. The trace shown in Figure 15A should be obtained.

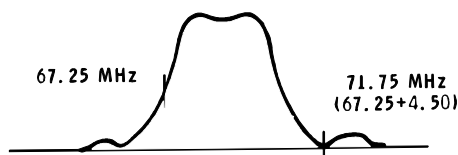

Figure 15A

- () Carefully adjust the fine tuning until the 71.75 MHz marker is at the bottom of the notch. The 67.25 MHz marker should be at about the 50% point of the curve as shown. After setting the fine tuning, do not disturb the setting during the remainder of the RF VSM alignment.
- () Disconnect the RF and clip-lead connections.

BANDPASS ALIGNMENT

- () Replace the clip-lead cable with the DEMODULATOR probe.
- () Set the SWEEP RANGE in the LO position.
- () Set the TINT and COLOR controls to center of rotation.
- () Connect equipment to receiver, per manufacturer's specifications and align the color bandpass output transformer. The curve should resemble the trace in Figure 16A.

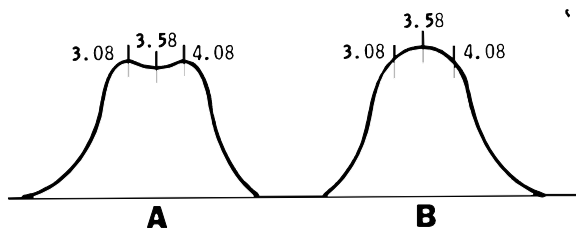

Figure 16

- () Reconnect the equipment as shown in Figure 16 (fold-out from Page 75).
- () Connect the RF cable through the matching pad to the antenna terminals.
- () Connect the proper bias to the tuner.
- () Turn the tuner to channel 4.
- () Turn on the 67.25 MHz marker.
- () Adjust the attenuator for minimum signal to produce visible trace. The trace will be somewhat noisy and should resemble Figure 16B.
- () Adjust the input color bandpass coil for a response as shown in Figure 16B.

CHECKING VHF TUNER ALIGNMENT THROUGH IF AMPLIFIERS

Check the alignment of the TV VHF tuner by performing the following procedure.

- () Check and align video IF.
- () Connect the sweep generator to the VHF tuner antenna terminals according to the manufacturer's instructions.
- () Connect a coaxial clip-lead cable to the TRACE INPUT connector on the Generator.
- () At the other end of the clip-lead cable, connect the inner lead through a 47 kΩ resistor to the TV set detector load. Ground the shield lead to the chassis as close to the detector load as possible.
- () Turn the channel selector to channel 4 and turn the Generator SWEEP RANGE switch to the RF position.
- () Turn on the 67.25 MHz marker switch. This is the picture carrier marker for channel 4.
- () Turn on the 4.50 MHz marker switch. A sound carrier marker should appear at 71.75 MHz, which is 4.50 MHz higher in frequency than the picture carrier.

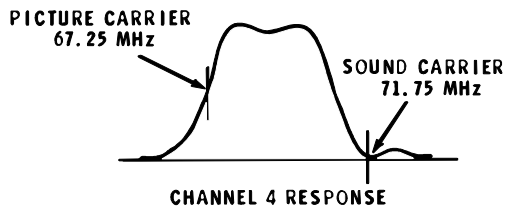

Figure 16C

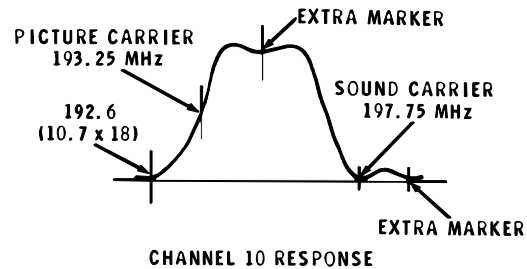

Figure 16D

- () Adjust the VHF tuner according to the manufacturer's instructions for the correct response for channel 4 as shown in Figure 16C.
- () Turn off the 67.25 MHz marker switch and turn the channel selector switch to channel 10.
- () Turn on the 193.25 MHz marker switch, which turns on the channel 10 picture carrier marker. A sound carrier marker should appear at 197.75 MHz, which is 4.50 MHz higher in frequency than the picture carrier.

NOTE: Spurious markers may appear on the trace along with the 193.25 MHz and 197.75 MHz markers. To verify the 193.25 MHz marker, turn off all markers and turn on only the 10.7 MHz marker switch. This produces a marker at 192.6 ($10.7 \times 18 = 192.6$). Figure 16D shows the location of the correct markers and the correct response for channel 10.

FM ALIGNMENT

RECEIVER TUNER AND IF ALIGNMENT

Align the IF coil and the discriminator in the FM tuner according to the following procedure.

- () Connect the Generator and oscilloscope to the IF circuit per the manufacturer's instructions.
- () Turn the SWEEP RANGE switch to the LO position and turn on the 10.7 MHz marker switch. Keep the Generator output low enough to prevent limiting.

- () Adjust the SWEEP CENTER control to position the 10.7 MHz marker at the center of the trace as shown in Figure 17A.

NOTE: Late model transistor and tube type FM tuners produce an IF response curve similar to Figure 17A. When the limiter stage is overdriven, the response curve flattens out as in Figure 17B. In many early FM tuners, an overcoupled IF circuit was used that produced the response curve of Figure 17C. Refer to the manufacturer's instructions for the proper response curve.

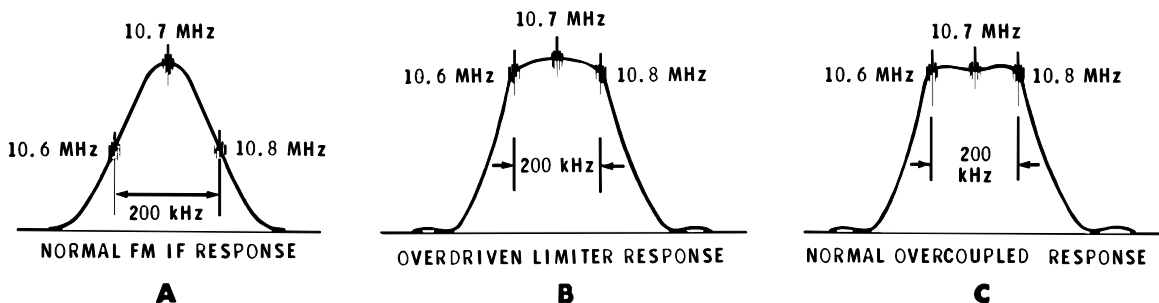

Figure 17

- () Turn on the 100 kHz marker switch. Markers should appear on the trace at the 10.6 MHz and 10.8 MHz locations.
- () Adjust the IF coils for the correct response as shown in Figure 17.
- () Use the same markers as stated above and align the discriminator according to the manufacturer's instructions. For this adjustment, the Generator output should be high enough so limiting will occur. Figure 18 shows the correct response curve for the discriminator.
- () Turn the SWEEP RANGE switch to the OFF position.

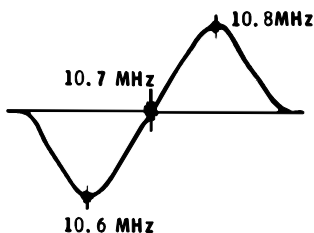

Figure 18

TUNER TRACKING

Perform the following steps to check for proper dial tracking of the FM tuner.

- () Connect the RF cable from the MARKER OUT connector on the Generator to the antenna terminals of the FM tuner.
- () Turn on the Generator MOD switch and the 45 MHz marker switch.
- () Adjust the FM tuner dial until a tone is heard. This should occur with the pointer of the FM tuner at 90 MHz on the FM dial.
- () Turn off the 45 MHz marker switch and turn on the 10.7 MHz marker switch.
- () Again adjust the FM tuner until a tone is heard. This should occur with the dial pointer at 107 MHz on the FM dial.

HEATHKIT MODEL ALIGNMENT

ALIGNMENT OF HEATHKIT MODEL GR-25, GR-180, GR-227, GR-295, GR-481, GR-581, AND GR-681 COLOR TV SETS

NOTE: Some of the Figures in the alignment section of the Assembly Manuals for the various Heathkit TV sets show a .001 μ F coupling capacitor being used in series with the RF cable. This capacitor is inside the pod of the RF cable used with this generator. Therefore, when you perform the alignment using the Model IG-57 Generator, do not use an additional .001 μ F capacitor.

The following equipment is needed for this alignment procedure.

1. Heathkit TV Post-Marker/Sweep Generator Model IG-57A.
2. Oscilloscope, such as the Heathkit Laboratory Oscilloscope, Model IO-14.
3. Voltmeter, such as the Heathkit Model IM-21 AC Vacuum Tube Voltmeter, or the Heathkit Model IM-16 and IM-25 High Impedance Electronic Voltmeters.



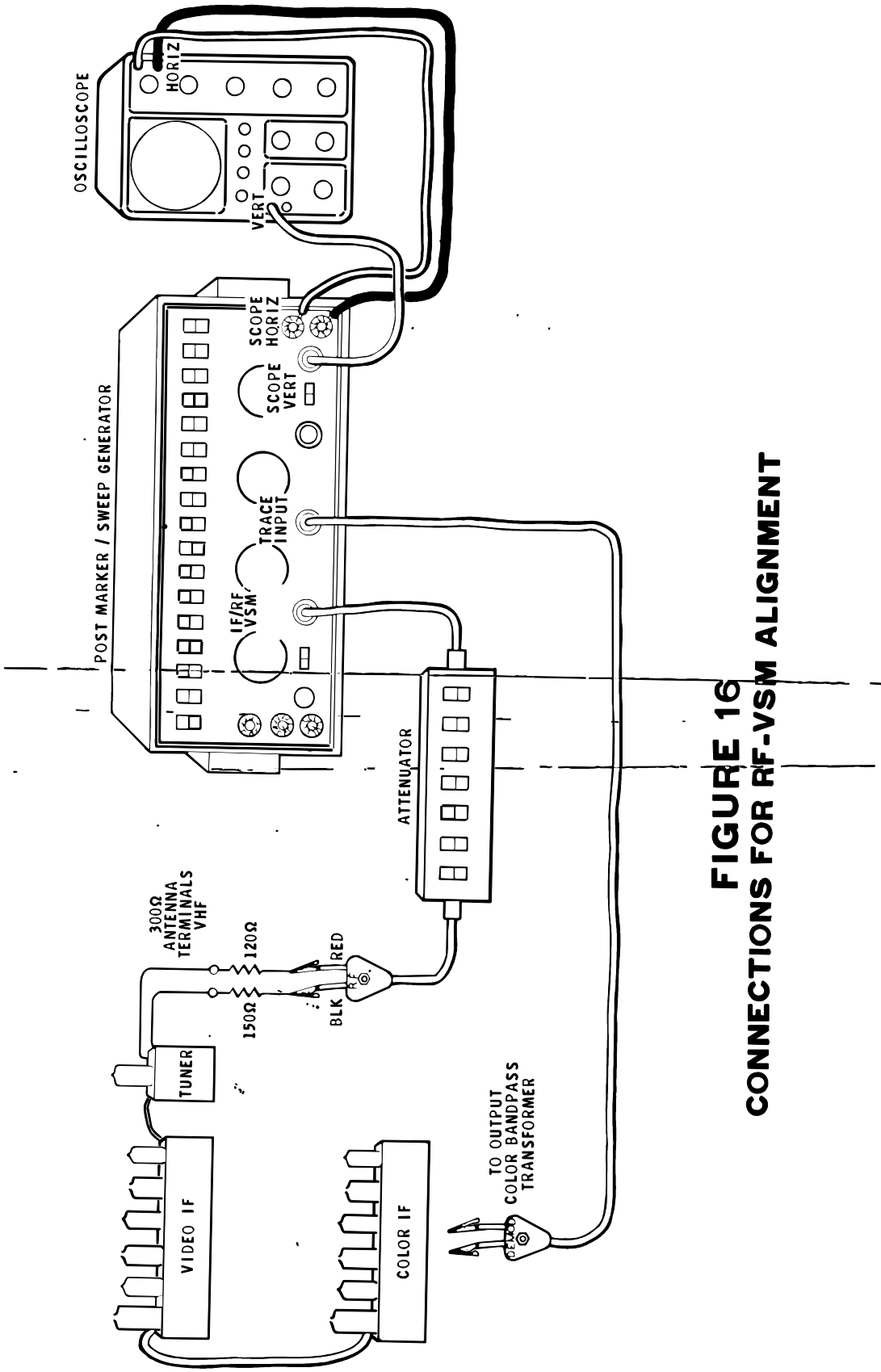

FIGURE 16
CONNECTIONS FOR RF-VSM ALIGNMENT

VIDEO IF ALIGNMENT

Preparation

CAUTION: Be sure the TV set is turned off when you perform the next three steps.

- () Remove the plate cap from the horizontal output tube.
- () Connect a 2500 Ω 100 watt resistor from the +390 V point to ground.
- () Set the TV set Normal-Service switch in the Service position.

Refer to Figure 19 (fold-out from this page) for the following steps.

- () Connect a 1 megohm resistor from point G (the IF AGC) to ground at socket V201.
- () Solder one lead of a 47 k Ω resistor to TP5 (test point 5) on the IF circuit board.
- () Connect the Generator CLIP-LEAD cable and the AC VTVM to the free lead of the 47 k Ω resistor. Set the VTVM to the lowest AC range.
- () Connect the Generator SCOPE HORIZ leads to the oscilloscope horizontal input and set the oscilloscope horizontal range switch to the external sweep position.

Connect the Generator SCOPE VERT cable to the oscilloscope vertical input. Set the oscilloscope vertical attenuator and gain controls to near their maximum gain position.

- () Turn off the AFT if set has this feature.
- () Turn the TV set VHF channel selector to channel 13. NOTE: In very strong signal areas, it may be necessary to remove the channel 13 strip from the tuner to disable the VHF oscillator.
- () Disconnect the antennas.

NOTE: When performing the alignment procedure, keep the Generator output signals as low as possible and still produce a clearly defined trace with markers.

Trap Alignment

- () Turn on the TV set and allow it to reach normal operating temperature.
- () Turn the SWEEP RANGE switch to the OFF position.
- () Connect the RF cable to the MARKER OUTPUT connector on the Generator.
- () Connect the other end of the RF cable to TP1 and ground on the VHF tuner as shown in Figure 19. Then perform the Trap Alignment as indicated in the following chart. Keep the marker output as low as possible.

TRAP ALIGNMENT CHART

TRAP	POST-MARKER/ SWEEP GENERATOR	ADJUST FOR MINIMUM
1. Sound trap	41.25 MHz and MOD Switches ON	Top slug of T204, R219. NOTE: Alternately adjust for T204 and R219 several times.
2. Adjacent channel sound trap	47.25 MHz and MOD Switches ON	NOTE: Alternately adjust L201 and R201 several times. Do not accidentally adjust T201 which is located between these two parts.



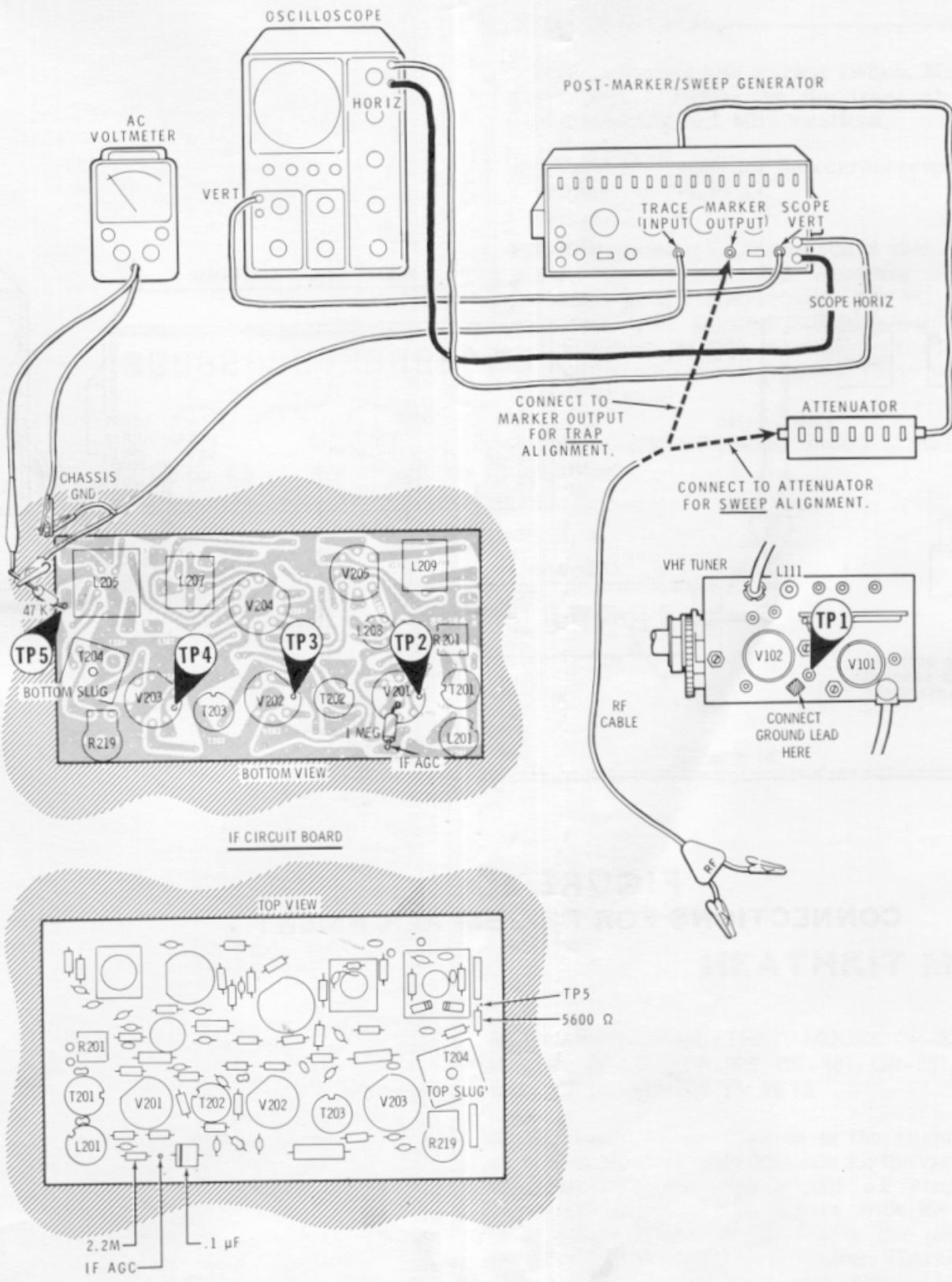

FIGURE 19
SWEEP ALIGNMENT

Sweep Alignment

Refer to Figure 19 for the following steps, and to the steps in the Sweep Alignment Chart.

- () Remove the 1 MΩ resistor between the IF AGC and ground; then connect a jumper wire in its place.
- () Turn the SWEEP RANGE switch to the IF position, and the MOD switch to the OFF position.
- () Remove the RF cable from the MARKER OUT connector and connect it to the Attenuator.

() Now perform the steps in the following Sweep Alignment Chart.

NOTE: The TRACE control determines the amplitude of the signal from the TV set that is applied to the vertical input of the oscilloscope. The amplitude of the sweep output signal applied to the TV set is controlled only by the Attenuator.

Therefore, when you perform the steps in the following chart, use the Attenuator switches to reduce the output of the Generator.

SWEEP ALIGNMENT CHART

STAGE	Connect generator to test point:*	Set Sweep Range switch to the IF position.	Marker switches ON:	Adjust for maximum gain and bandwidth	NOTES
1. 3rd IF T204	TP4 (pin 2 of V203)		42.17 MHz 45.00 MHz 45.75 MHz	T204 (bottom slug)	Adjust Trace control for approximately 2" of vertical deflection. Keep marker output as low as possible and still show markers clearly.
2. 2nd IF T203	TP3 (pin 1 of V202) Caution: 133V at this point.		41.25 MHz 42.17 MHz 42.50 MHz 45.75 MHz	T203	Reduce output of Generator.
3. 1st IF T202	TP2 (pin 1 of V201)		41.25 MHz 42.17 MHz 45.00 MHz 45.75 MHz	T202	Reduce output of Generator.
4. Overall IF response	TP1 (mixer grid)		41.25 MHz 42.17 MHz 42.50 MHz 45.00 MHz 45.75 MHz 47.25 MHz	L112 Mixer plate coil T201 IF input coil	Reduce output of Generator. If necessary, retouch preceding IF adjustments to obtain the correct overall response.

*Connect the generator ground lead to the center ground pin of the tube socket.

- () After completing the sweep alignment, recheck the trap alignment. Readjust the traps if needed. Make a final check of the overall response.
- () Disconnect the test leads. Disconnect the 47 kΩ resistor from TP5 and disconnect the jumper wire between point G and socket V201.

COLOR ALIGNMENT

Refer to Figure 20 for the following steps.

3.58 MHz Transformer (T403) Adjustment

- () Connect a VTVM (or electronic voltmeter), set to read negative DC voltage on the 15 volt range, to TP10.
- () Adjust T403 for a maximum voltage reading.
- () Disconnect the voltmeter.

Bandpass Alignment

- () Remove horizontal oscillator tube (V303) and third video IF tube (V203).
- () Set the TV set Color Control to midrange.
- () Connect the Demodulator cable red lead to TP9 and the black lead to chassis ground.
- () Connect the RF cable red lead to TP8 (pin 2 of V403) and the black lead to the center ground pin of V403.
- () Set the SWEEP RANGE switch to the LO position.
- () Turn on the 3.08, 3.58, and 4.08 MHz marker switches and adjust the top and bottom slugs in T401 for the response curve shown in Figure 21A.
- () Remove the RF cable from TP8 and ground and connect it to TP5 and chassis ground. (See Figure 19 for the location of TP5.) Reduce the output of the Generator.
- () Adjust the slug in L402 for the response curve shown in Figure 21B. NOTE: The marker from the TV set's 3.58 MHz oscillator may also appear and distort the trace. Remove the TV set's 3.58 MHz color oscillator tube.
- () Replace tubes V303 and V203.

This completes the Color Bandpass Alignment. Disconnect the RF and Demodulator cables from the TV set.

Bandpass Alignment-IF VSM

The IF VSM method provides more accurate setting of the bandpass plate coil (L402). Before this alignment is performed, the video IF and the output color bandpass transformer T401 must be correctly aligned. The video IF alignment is outlined on Page 76.

Refer to Figure 20 and align T401 as follows:

- () Remove the horizontal oscillator tube (V303) and the third video IF tube (V203).
- () Set the TV set Color Control to midrange.
- () Connect the Demodulator cable red lead to TP9 and the black lead to chassis ground.
- () Connect the RF cable red lead to TP8 (pin 2 of V403) and the black lead to the center ground pin of V403.
- () Set the SWEEP RANGE switch to the LO position.
- () Turn on the 3.08, 3.58, and 4.08 MHz marker switches and adjust the top and bottom slugs in T401 for the response curve shown in Figure 21A.

Refer to Figure 20 and align the bandpass plate coil in the following steps:

- () Replace tubes V203 and V303.
- () Disconnect the attenuator cable from SWEEP OUTPUT jack on the rear panel, and connect it to IF/RF VSM jack.
- () Connect the RF cable to the mixer grid of the tuner (TP1).
- () Connect a shorting wire from IF AGC to ground (see Figure 19).
- () Set the channel selector to VHF channel 13.
- () Turn on the 45.75 MHz marker.
- () Adjust the plate bandpass coil L402 for the waveform shown in Figure 21C.

This completes the IF-VSM Bandpass Alignment.



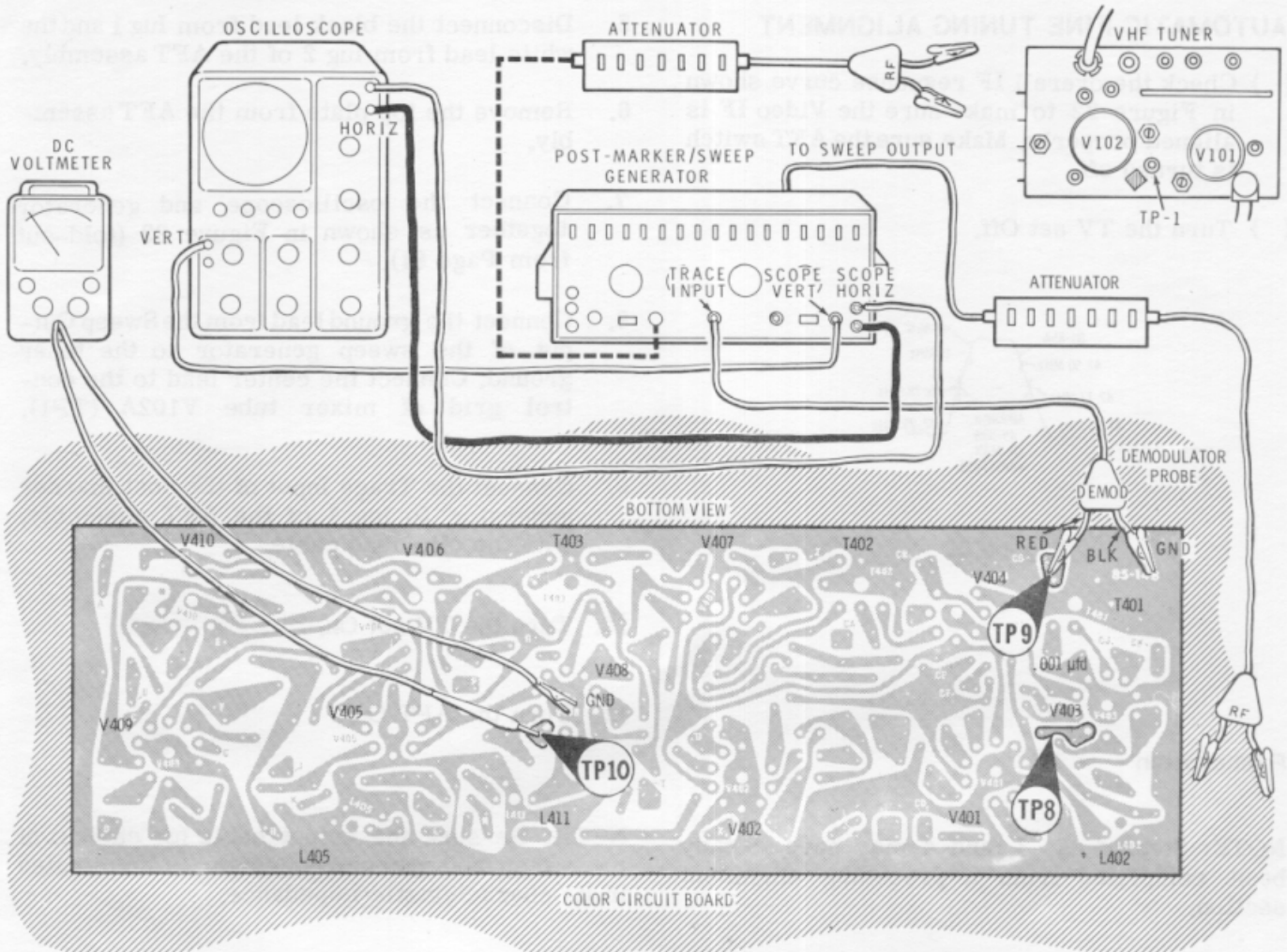

Figure 20 COLOR AND BANDPASS ALIGNMENT

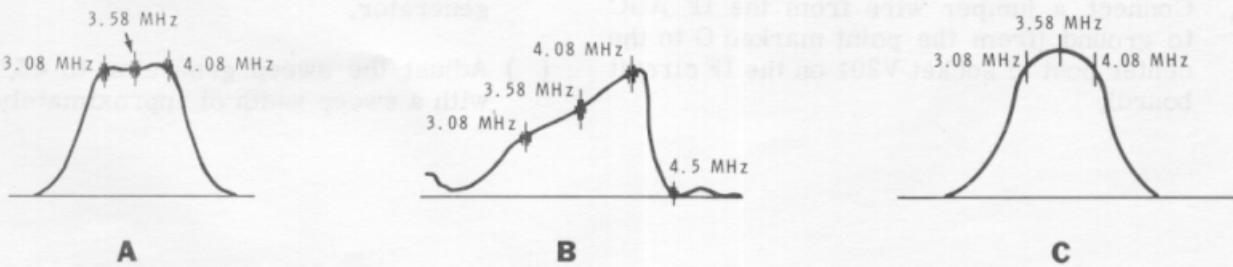

Figure 21



AUTOMATIC FINE TUNING ALIGNMENT

- () Check the overall IF response curve shown in Figure 22 to make sure the Video IF is aligned properly. Make sure the AFT switch is turned off.
- () Turn the TV set Off.

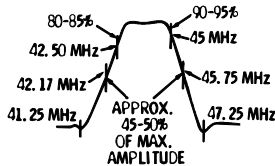

Figure 22

- 5. Disconnect the black lead from lug 1 and the white lead from lug 2 of the AFT assembly.
- 6. Remove the top plate from the AFT assembly.
- 7. Connect the oscilloscope and generator together as shown in Figure 23 (fold-out from Page 81).
- 8. Connect the ground lead from the Sweep Output of the sweep generator to the tuner ground. Connect the center lead to the control grid of mixer tube V102A (TP1).
- 9. Connect the Trace Input of the post marker generator to lug 1 of the AFT assembly, with the clip-lead cable.
- 10. Turn the TV set On.
- 11. Turn the AFT On.

Preparation

NOTE: Steps 1, 2, 3, and 4 may have already been completed from a preceding alignment section.

- 1. Remove the plate cap from tube V701.
- 2. Connect a 2500 Ω 100 watt resistor from lug 3 of terminal strip BH (± 390 V) to ground.
- 3. Set the NORMAL-SERVICE switch in the SERVICE position.
- 4. Connect a jumper wire from the IF AGC to ground (from the point marked G to the center post of socket V201 on the IF circuit board).

NOTE: Be sure the output cable (or cables) of the sweep and marker generator is terminated in its characteristic impedance.

Alignment

- () Set the vertical gain of the oscilloscope to maximum.
- () Set the oscilloscope horizontal to line sweep, or use the horizontal sweep from the sweep generator.
- () Adjust the sweep generator to 45.75 MHz with a sweep width of approximately 2 MHz.

Refer to **Figure 23** for the following steps.

- () Adjust coil L901 until the top of the slug is even with the top of the coil form.
- () Adjust the output of the sweep generator until the top and bottom peaks of the waveform are just clipped as shown in Part A of **Figure 23**. NOTE: If the AFT was completely misaligned, a waveform may not be obtained. In this case, adjust the sweep generator for maximum output disregarding the absence of a waveform.
- () Adjust coils L902 and L903 so the base widths of the waveform are equal and maximum as shown. NOTE: Some oscilloscopes may show the waveform inverted.
- () Decrease the output of the sweep generator until the top and bottom peaks of the waveform just begin to round, but still remain clipped as shown in waveform B.
- () Adjust coils L901 and L902 for maximum and equal base width as shown in waveform B. When these coils are correctly adjusted, coil L901 will have the greatest affect on the outer slope of the higher frequency side.
- () Decrease the sweep width of the sweep generator and readjust L903 until the 45.75 MHz marker appears as shown in waveform C.
- () Increase the sweep width and recheck waveform A. Adjust L901 and L902 if necessary.
- () Turn the TV set Off.
- () Disconnect the test leads from the AFT assembly and VHF tuner.
- () Resolder the white lead to lug 1 of the AFT assembly.
- () Resolder the black lead to lug 2 of the AFT assembly.
- () Reinstall the AFT cover. Make sure the access hole is over L903.
- () Disconnect the 2500 Ω 100 watt resistor from lug 3 of terminal strip BH.
- () Reinstall the plate cap on tube V701.
- () Disconnect the jumper wire which is connected between IF AGC and ground.
- () Set the Normal-Service switch to Normal.
- () Turn the AFT switch Off (Contrast control pulled out).
- () Turn the TV set On and tune in a color picture.
- () Turn the AFT switch On and Off several times. There should not be any noticeable change in the picture or sound. Repeat this procedure on other VHF and UHF channels. If there is a noticeable difference in the picture or sound, adjust coil L903 no more than 1/8 turn in either direction until there is no change.

This completes the AFT alignment.



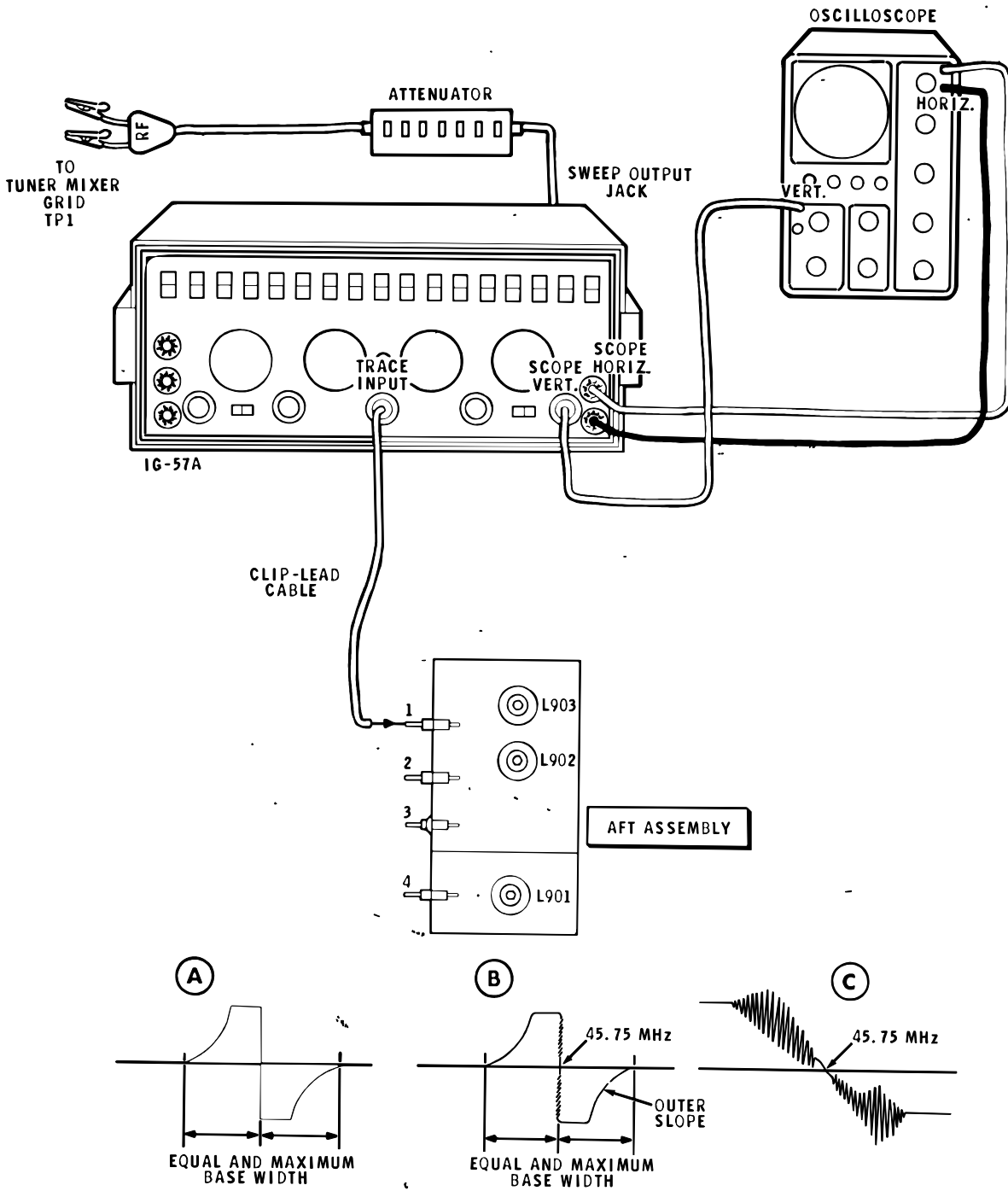

FIGURE 23

CONNECTIONS AND RESPONSE WAVEFORMS FOR THE AUTOMATIC FINE TUNING (AFT) ALIGNMENT

RF ALIGNMENT

Refer to Figure 24 for the following steps.

- () Connect an antenna matching pad (one 120 Ω and one 150 Ω resistor) to the antenna terminals of the VHF tuner.
- () Connect the red lead of the RF cable pod to the free end of the 120 Ω resistor and the black lead to the free end of the 150 Ω resistor.
- () Turn the AFT off.
- () Connect a clip-lead cable to the TRACE INPUT connector.
- () Connect a .05 μ F 50 V capacitor to TP-12. Connect the inner lead of the clip-lead cable to this capacitor and the shield lead to ground. Refer to the TV manual for the location of TP-12.
- () Connect the Bias Leads from the Generator to the tuner as shown. Adjust the BIAS control to provide -2.5 volts to the tuner.

NOTE: The Model IG-57A Generator provides markers for only VHF channels 4 and 10.

- () Turn the Channel Selector to the channel 4 position.
- () Turn the sweep generator to the RF position.
- () Set the Post Marker Generator 67.25 MHz (picture carrier) and the 4.5 MHz Marker switches to On. NOTE: The 4.5 MHz signal will beat with the 67.25 MHz picture carrier signal and produce a marker at 71.75 MHz on the trace which will be the sound carrier marker.
- () Adjust capacitors C113 and C114 for the correct response, as shown.

- () Turn off the 67.25 MHz marker.
- () Check the effect of this coil adjustment on the high channels by turning the TV channel selector to channel 10 and turning on the 193.25 MHz marker. Adjust the SWEEP CENTER control to display the channel 10 response curve on the oscilloscope.

NOTE: The 4.50 MHz signal will beat with the 193.25 MHz picture carrier signal and produce a marker at 197.75 MHz on the trace which will be the sound carrier marker. Two other markers may appear on the trace along with the 193.25 MHz and 197.25 MHz markers. To verify the 193.25 MHz marker, turn off all markers and turn on only the 10.7 MHz Marker switch. This produces a marker at 192.6 ($10.7 \times 18 = 192.6$). Refer to Figure 16D on Page 74 for 197.25 marker.

- () If the tilt or valley between the markers cannot be adjusted to within the 30% maximum tolerance, it can be brought within limits by physically compressing or expanding coil L107 for the low channels (2-6).

NOTE: If the bandwidth is too wide or too narrow on the high channel, it can be corrected by compressing or expanding coil L112. If the RF amplifier tube is changed, it may also be necessary to adjust RF neutralizing capacitor, C109, to obtain a bandwidth as shown in Figure 24.

- () Shut off the TV set and disconnect the alignment equipment.
- () Disconnect the 2500 Ω 100 watt resistor and replace the plate cap on the horizontal output tube.
- () Set the NORMAL-SERVICE switch to the NORMAL position.
- () Disconnect the .05 μ F capacitor, the 120 Ω , and the 150 Ω resistors from the VHF tuner.

This completes the "RF Alignment."



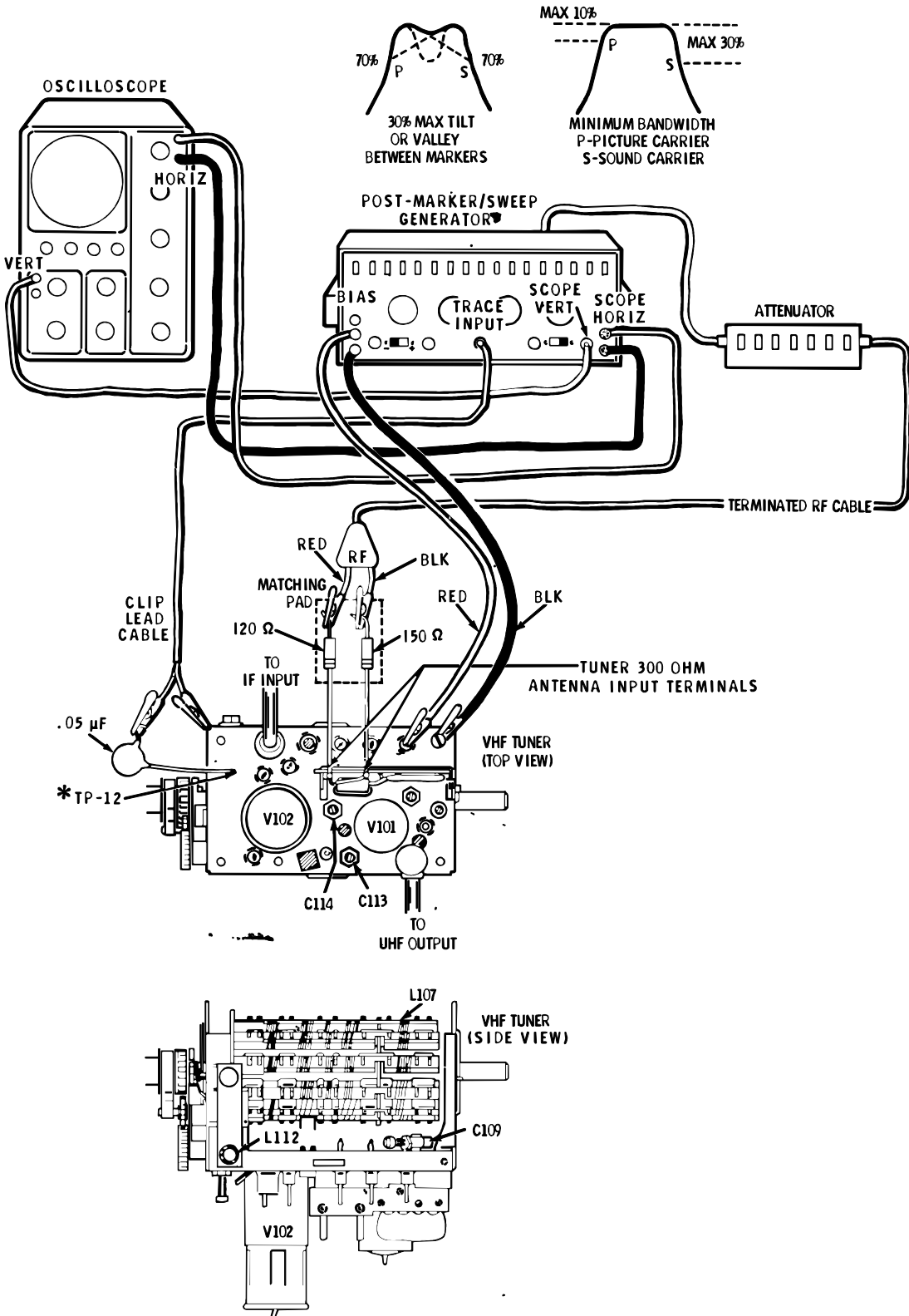

* REFER TO THE TV MANUAL FOR THE CORRECT POSITION OF TP-12.

Figure 24

BLANK PAGE



IN CASE OF DIFFICULTY

This section of the Manual is divided into three parts: Visual Test, Precautions For Troubleshooting, and the Troubleshooting Charts. Begin your search for any troubles that occur after assembly by carefully following the checks listed in the Visual Test section. After visual tests are completed, refer to Precautions for Troubleshooting and to the Troubleshooting Charts.

NOTE: In an extreme case where you are unable to resolve a difficulty, refer to the Service and Warranty section of the "Kit Builders Guide" and to the "Factory Repair Service" information on Page 89 of this Manual. If the Post-Marker/Sweep Generator is returned to the Heath Company, be sure all cables are included.

NOTE: Refer to the Circuit Board X-Ray Views (Pages 111 and 112) and Chassis Photos (Page 107) for physical locations of parts on the circuit boards and on the chassis.

VISUAL TESTS

1. About 90% of the kits that are returned for repair, do not function properly due to poor connections and soldering. Therefore, many troubles can be eliminated by a careful inspection of connections to make sure they are soldered as described in the Proper Soldering section of the Kit Builders Guide. Reheat any doubtful connections and be sure all the wires are soldered at places where several wires are connected.
2. Check to be sure that all transistors are in their proper locations, and are installed correctly.
3. Check the values of the parts. Be sure that the proper part has been wired into the circuit, as shown in the Pictorial diagrams and as called out in the wiring instructions. It would be easy, for example, to install a 2200 Ω (red-red-red) resistor in a step that calls for a 220 Ω (red-red-brown) resistor.

4. Recheck the wiring. Trace each lead in colored pencil on the Pictorial as it is checked. It is frequently helpful to have a friend check your work. Someone who is not familiar with the unit may notice something you have consistently overlooked.
5. Check all wires connected to the circuit boards. Make sure the wires do not extend through the circuit board and make contact with other connections such as component leads.
6. Check for bits of solder, wire ends, or other foreign matter which may be lodged in the wiring.

NOTE: A review of the Circuit Description may help you determine where a trouble is located.

PRECAUTIONS FOR TROUBLESHOOTING

1. Be cautious when testing transistor circuits. Although transistors have almost unlimited life when used properly, they are much more vulnerable to damage from excessive voltage or current than tubes. A vacuum tube can often be operated under shorted, zero-bias, excessive-voltage, or high-current conditions for short periods of time without materially damaging the tube. Any one of these same conditions can instantly destroy a transistor.
2. Be sure you do not short any terminals to ground when making voltage measurements. If the probe should slip, for example, and short out a bias or voltage supply point, it is almost certain to cause damage to one or more transistors or diodes.
3. Transistors should be removed or inserted only while the Generator is turned off. If this rule is not followed, transistors may be damaged.



Troubleshooting Chart

AMPLIFIER AND OSCILLATOR SECTION

SYMPTOM	CAUSE	CURE
Pilot lamp does not glow.	<ol style="list-style-type: none"> 1. Generator line cord plug not inserted into AC outlet. 2. Open or incorrect resistor in series with pilot lamp. 3. Incorrect wiring of terminal strip on chassis, or rear panel. 4. Defective line cord, outlet, pilot lamp, or on-off switch. 	<ol style="list-style-type: none"> 1. Plug unit into AC outlet. 2. Check wiring of pilot lamp circuit and correct any errors. 3. Check wiring of terminal strip on chassis and rear panel and correct any errors. 4. Replace defective components.
No B+ voltage (+13.6 VDC).	<ol style="list-style-type: none"> 1. Incorrect value of R84 and R85. 2. Shorted zener diode ZD1. 3. Defective diode D1 or D2, power transformer T1, or filter capacitor C76 and C77. 	<ol style="list-style-type: none"> 1. Check resistance values and correct any errors. 2. Replace zener diode ZD1. 3. Replace defective components.
High B+ voltage (over 14.9 VDC).	<ol style="list-style-type: none"> 1. Defective zener diode ZD1. 	<ol style="list-style-type: none"> 1. Replace defective component.
3.08 to 10.7 MHz oscillator inoperative or low output.	<ol style="list-style-type: none"> 1. Incorrect value of resistor or capacitor within the defective circuit. 2. Defective transistor or crystal within the defective circuit. 	<ol style="list-style-type: none"> 1. Check resistance and capacitance values and correct any errors. 2. Replace defective components.
39.75 to 193.25 MHz oscillator inoperative or low.	<ol style="list-style-type: none"> 1. Incorrect value of resistor or capacitor within the defective circuit. 2. Oscillator coil misaligned. 3. Defective transistor or crystal within the defective circuit. 	<ol style="list-style-type: none"> 1. Check resistance and capacitance values and correct any errors. 2. Check oscillator coil alignment. 3. Replace defective components.
No bias voltage.	<ol style="list-style-type: none"> 1. Defective diode D3, capacitor C74 or C75, power transformer T1, resistor R83 or Bias control. 	<ol style="list-style-type: none"> 1. Replace defective components.
No marker.	<ol style="list-style-type: none"> 1. Incorrect wiring of Trace/Marker control. 2. Incorrect value of resistor or capacitor within the marker amplifier circuit. 3. MOD switch is On. 4. Oscillator coil misaligned. 5. Defective Marker control. 	<ol style="list-style-type: none"> 1. Check control wiring. 2. Check resistance and capacitance values and correct any errors. 3. Turn MOD switch to Off. 4. Check oscillator coil alignment. 5. Replace defective component.

AMPLIFIER AND OSCILLATOR SECTION (cont'd.)

SYMPTOM	CAUSE	CURE
Excessive marker or unable to turn marker completely off with Marker control.	1. Incorrect value of capacitor C86.	1. Check capacitance value and correct any errors.
No trace.	1. Defective marker or trace amplifier.	1a. Check all wiring around Q20. Also check Q20. 1b. Check for shorted capacitor C84 or other defective components.
Excessive noise (hash) on trace or marker. Noise increases when Marker control is advanced.	1. Transistor Q17, Q18, Q19 or Q20. 2. Incorrect Trace or Marker control wiring.	1. Replace defective transistors. 2. Check wiring from Trace and Marker controls to amplifier circuit board.

SWEEP SECTION

SYMPTOM	CAUSE	CURE
No control of sweep width or voltage at TP3 (emitter of Q23). NOTE: Be sure the shield lead of the short 75 Ω coaxial cable is soldered securely in hole J and to the control solder lug at the Sweep Output connector.	1. Poor solder connections at D or X on circuit board. 2. Open L15 winding in controllable inductor. Resistance from D to ground should be 500 Ω \pm 15%. 3. Transistor Q23 shorted or incorrectly connected. 4. Capacitor C209 or C211. 5. Incorrect wiring to sweep shield connections. 6. Incorrect wiring to Sweep Width and Sweep Center controls or Sweep Range switch.	1. Check and resolder D and X. 2. Measure resistance from lead to ground. Replace inductor if winding is open. 3. Check Q23. Replace if necessary. 4. Replace C209 or C211. 5. Check and correct wiring. 6. Check and correct wiring.
No horizontal deflection of oscilloscope trace.	1. Incorrect wiring to Trace Reverse switch. 2. Capacitor C228 or C229. 3. Incorrect wiring to 7-lug terminal strip.	1. Check and correct wiring. 2. Replace capacitor C228 or C229. 3. Check terminal strip connections and wiring.
No sweep when using Demodulator or RF cables.	1. Defective wiring or shorted Demodulator or RF cable. 2. Diode in Demodulator cable.	1. Check and correct wiring in defective cable. 2. Replace diode.

SWEEP SECTION (cont'd.)

SYMPTOM	CAUSE	CURE
No blanking when Blanking switch is in ON position.	<ol style="list-style-type: none"> 1. Capacitor C208. 2. Faulty or incorrectly installed transistor Q27. 3. Incorrect wiring to Trace Reverse or Blanking switches. 4. Incorrectly installed or faulty diode D4. 	<ol style="list-style-type: none"> 1. Replace capacitor. 2. Check and correct installation of Q27 or replace Q27. 3. Check and correct switch wiring. 4. Check or replace diode D4.
No LO band output.	<ol style="list-style-type: none"> 1. Transistor Q26. 2. Capacitors C214, C215, or C216. 3. Poor solder connections (leads of L15A) to circuit board holes S or T. 4. Resistor R211. 	<ol style="list-style-type: none"> 1. Replace Q26. 2. Check and replace faulty capacitor. 3. Resolder connection in holes S and T. 4. Replace R211.
No IF band output.	<ol style="list-style-type: none"> 1. Transistor Q24. 2. Capacitors C218, C219, or C220. 3. Poor solder connections (leads of L15B) to circuit board holes L or M. 4. Resistor R212. 	<ol style="list-style-type: none"> 1. Replace Q24. 2. Check and replace faulty capacitor. 3. Resolder connections in holes L and M. 4. Replace R212.
No RF band output.	<ol style="list-style-type: none"> 1. Transistor Q25. 2. Capacitors C222, C223, or C224. 3. Poor solder connections (leads of L15C) to circuit board holes R or N. 4. Incorrect setting of capacitor C223. 5. Resistor R213. 	<ol style="list-style-type: none"> 1. Replace Q25. 2. Check and replace faulty capacitor. 3. Resolder connections in holes R and N. 4. Refer to Test And Adjustment section of Manual for correct adjustment procedure. 5. Replace R213.
No VSM output.	<ol style="list-style-type: none"> 1. No carrier. 2. Incorrect connections to receiver, or receiver prepared incorrectly. 3. Incorrect wiring of terminal strip. 4. Diode D5. 	<ol style="list-style-type: none"> 1. Turn on carrier frequency. 2. Check the connections and preparation steps. 3. Check VSM steps. 4. Replace the diode.

ATTENUATOR

SYMPTOM	CAUSE	CURE
No sweep output when using attenuator.	<ol style="list-style-type: none"> 1. Attenuator cable open or shorted. 2. No jumper connected or poor solder connection between lugs 1 and 4 of one or more rocker switches. 3. Jumper between lug 5 of one switch and lug 2 of the next switch shorted to hole in switch shield. 4. Jumper missing or poor solder connection between coaxial connectors and lug 2 of attenuator switch EA, or lug 5 of switch EG. 5. Incorrect switch wiring or faulty rocker switch. 	<ol style="list-style-type: none"> 1. Check and repair attenuator. 2. Resolder all connections or install missing jumper. 3. Position jumper through holes in switch shields so they do not touch the metal shield. 4. Install missing jumper or resolder connections to coaxial connector and switch. 5. NOTE: See the "Attenuator Resistance Check" (Page 91) for correct operation of attenuator.

FACTORY REPAIR SERVICE

You can return your completed kit to the Heath Company Service Department to have it repaired for a minimum service fee. (Kits that have been modified will not be accepted for repair.) If you wish, you can deliver your kit to a nearby Heath Authorized Service Center. These centers are listed in your Heathkit catalog.

To be eligible for replacement parts under the terms of the warranty, equipment returned for factory repair service, or delivered to a Heath Authorized Service Center, must be accompanied by the invoice or the sales slip, or a copy of either. If you send the original invoice or sales slip, it will be returned to you.

If it is not convenient to deliver your kit to a Heath Authorized Service Center, please ship it to the factory at Benton Harbor, Michigan and follow the following shipping instructions:

Prepare a letter in duplicate, containing the following information:

- Your name and return address.
- Date of purchase.
- A brief description of the difficulty.
- The invoice or sales slip, or a copy of either.

- Your authorization to ship the repaired unit back to you C.O.D. for the service and shipping charges, plus the cost of parts not covered by the warranty.

Attach the envelope containing one copy of this letter directly to the unit before packaging, so that we do not overlook this important information. Send the second copy of the letter by separate mail to Heath Company, Attention: Service Department, Benton Harbor, Michigan.

Check the equipment to see that all parts and screws are in place. (Do not include wooden cabinets when shipping receivers, tuners, amplifiers, or TV sets, as these are easily damaged in shipment.) Then, wrap the equipment in heavy paper. Place the equipment in a strong carton, and put at least **THREE INCHES** of resilient packing material (shredded paper, excelsior, etc.) on all sides, between the equipment and the carton. Seal the carton with gummed paper tape, and tie it with a strong cord. Ship it by prepaid express, United Parcel Service, or insured parcel post to:

Heath Company
 Service Department
 Benton Harbor, Michigan 49022

Blank Page



ATTENUATOR RESISTANCE CHECK

An attenuator is a device which provides signal reduction without any change in the impedance at its input provided the device is properly terminated. The RF cable provides the proper termination for the attenuator.

To check the attenuator proceed as follows:

- () Push down on the lower end of all seven rocker switches.
- () Plug the RF cable into the connector at either end of the attenuator.
- () Connect one lead of an ohmmeter to the centerpin of the connector at the other end of the attenuator. Connect the other ohmmeter lead to the outside (ground) shell of the connector.
- () Set the ohmmeter range switch to the Low Ohms position. The ohmmeter reading should be $75 \Omega \pm 5\%$.

NOTE: In the next step, if the ohmmeter reading changes when a rocker switch is pushed IN, it indicates that the switch is defective or improperly wired.

- () Now, pushing the rocker switches IN one at a time, or in any group or combination should not change the $75 \Omega \pm 5\%$ reading of the ohmmeter.

Blank Page



SPECIFICATIONS

Marker Frequencies.	100 kHz.
Crystal Controlled, $\pm 0.01\%$.	3.08 MHz, 3.58 MHz, 4.08 MHz, 4.50 MHz.
Crystal Controlled, $\pm 0.005\%$.	10.7 MHz, 39.75 MHz, 41.25 MHz, 42.17 MHz, 42.50 MHz, 42.75 MHz, 45.00 MHz, 45.75 MHz, 47.25 MHz, 67.25 MHz, 193.25 MHz.
Modulation Frequency.	400 Hz.
Input Impedances.	External MKR/SWP - 75 Ω . Trace Input - 220 k Ω . Attenuator - 75 Ω .
Output Impedances.	Marker Out - 75 Ω . Scope Vert - 1 k Ω . Sweep Output - 75 Ω . Attenuator - 75 Ω . IF/RF VSM - 75 Ω .
Bias Voltage.	Positive or negative 15 volts DC at 10 milli- amperes.
Type of Marker.	Birdie.
Controls.	Two individually adjustable Bias controls. Marker/Trace - dual concentric. Sweep Width/Sweep Center - dual concentric. Marker Out - concentric with Sweep Range switch. Phase.
Switches.	Rocker type - separate switch for each of the above listed frequencies. Blanking, On/Off. Trace Reverse. Modulation On/Off. Power On/Off. Bias + or -.



Transistor-Diode Complement.	18 - 2N3692 transistors. 6 - 2N3393 transistors. 1 - 2N3416 transistor. 2 - 40245 transistors. 3 - silicon diode rectifiers. 3 - crystal diodes. 1 - 13.6 volt zener diode. 1 - 20 volt zener diode.
Sweep Frequency Ranges and Output Voltage. . .	LO Band - 2.5 to 5.5 MHz ± 1 dB at 0.5 volt RMS minimum, fundamentals, with 10.7 MHz on harmonics. IF Band - 38 to 49 MHz ± 1 dB at 0.5 volt RMS minimum, fundamentals. RF Band - 64 to 72 MHz ± 1 dB at 0.5 volt RMS minimum, fundamentals, with 192 to 198 MHz on harmonics.
Attenuator.	Total of 70 dB of attenuation in seven steps - 1 dB, 3 dB, 6 dB, 10 dB, 10 dB, 20 dB, and 20 dB.
Power Requirements.	120 volts, 60 Hz AC at 4.5 watts.
Dimensions.	13-3/8" wide x 5-1/2" high x 12" deep.
Net Weight.	14 lbs.

The Heath Company reserves the right to discontinue instruments and to change specifications at any time without incurring any obligation to incorporate new features in instruments previously sold.



CIRCUIT DESCRIPTION

INTRODUCTION

The following Circuit Description is in two parts. The first part describes each circuit in the Post Marker section of the Generator. The second part describes each circuit in the Sweep section of the Generator. Refer to the Block Diagram (fold-out from Page 96) and to the Schematic (fold-out from Page 117) while you read this Circuit Description. The Block Diagram shows the relationship between the inputs, outputs, controls, and functional circuits of the complete TV Post-Marker/Sweep Generator.

POST MARKER GENERATOR

Some of the oscillators operate at the fundamental frequency of their crystals while some operate on the third or fifth overtone of their crystal. The following chart lists each oscillator and identifies each one by the transistor Q number, output frequency, crystal frequency, crystal mode of operation, and the type of oscillator circuit.



OSCILLATOR	OUTPUT FREQ	CRYSTAL FREQ	MODE	TYPE OSC CIRCUIT
Q1	57.25 MHz	67.25 MHz	5th overtone	Miller
Q2	193.25 MHz	96.625 MHz	5th overtone	Miller
Q3	45.75 MHz	45.75 MHz	3rd overtone	Miller
Q4	47.25 MHz	47.25 MHz	3rd overtone	Miller
Q5	42.75 MHz	42.75 MHz	3rd overtone	Miller
Q6	45.00 MHz	45.00 MHz	3rd overtone	Miller
Q7	42.17 MHz	42.17 MHz	3rd overtone	Miller
Q8	42.50 MHz	42.50 MHz	3rd overtone	Miller
Q9	39.75 MHz	39.75 MHz	3rd overtone	Miller
Q10	41.25 MHz	41.25 MHz	3rd overtone	Miller
Q11	4.08 MHz	4.08 MHz	fundamental	Pierce
Q12	10.7 MHz	10.7 MHz	fundamental	Pierce
Q13	3.58 MHz	3.58 MHz	fundamental	Pierce
Q14	4.5 MHz	4.5 MHz	fundamental	Pierce
Q15	3.08 MHz	3.08 MHz	fundamental	Pierce
Q16	100 kHz	No crystal	L tuned	Colpitts

Each marker oscillator is turned on when its marker switch applies DC voltage (+13.6 volts) to the desired oscillator circuit. Since each marker frequency is generated by a separate oscillator, a number of markers may be produced at the same time by turning on the desired marker switches. The outputs of all marker oscillators are coupled together through DC blocking capacitors and applied through a common RF buss to the Marker Out control. Turning on the MOD switch energizes the 400 Hz oscillator, which in turn modulates all oscillators whose marker switches are turned on. NOTE: With the MOD switch turned ON, marker amplifier Q18 is biased to cutoff by resistor R109. Therefore, no markers will appear on the oscilloscope trace.

With the MOD switch in the off position, the output of each marker oscillator is applied to the input of the marker amplifier. These marker signals are mixed with the sweep signal from the sweep section of the Generator and with any external marker signal fed into the Generator's External Marker input jack.

The amplifier output signal is applied across Marker control R108, which adjusts the amplitude of the signals applied to trace amplifier Q19 and Q20. The marker signals are then mixed with the demodulated input signal that appears across the Trace control. The signals from the Marker and the Trace amplifier are applied to the Scope Vert jack.



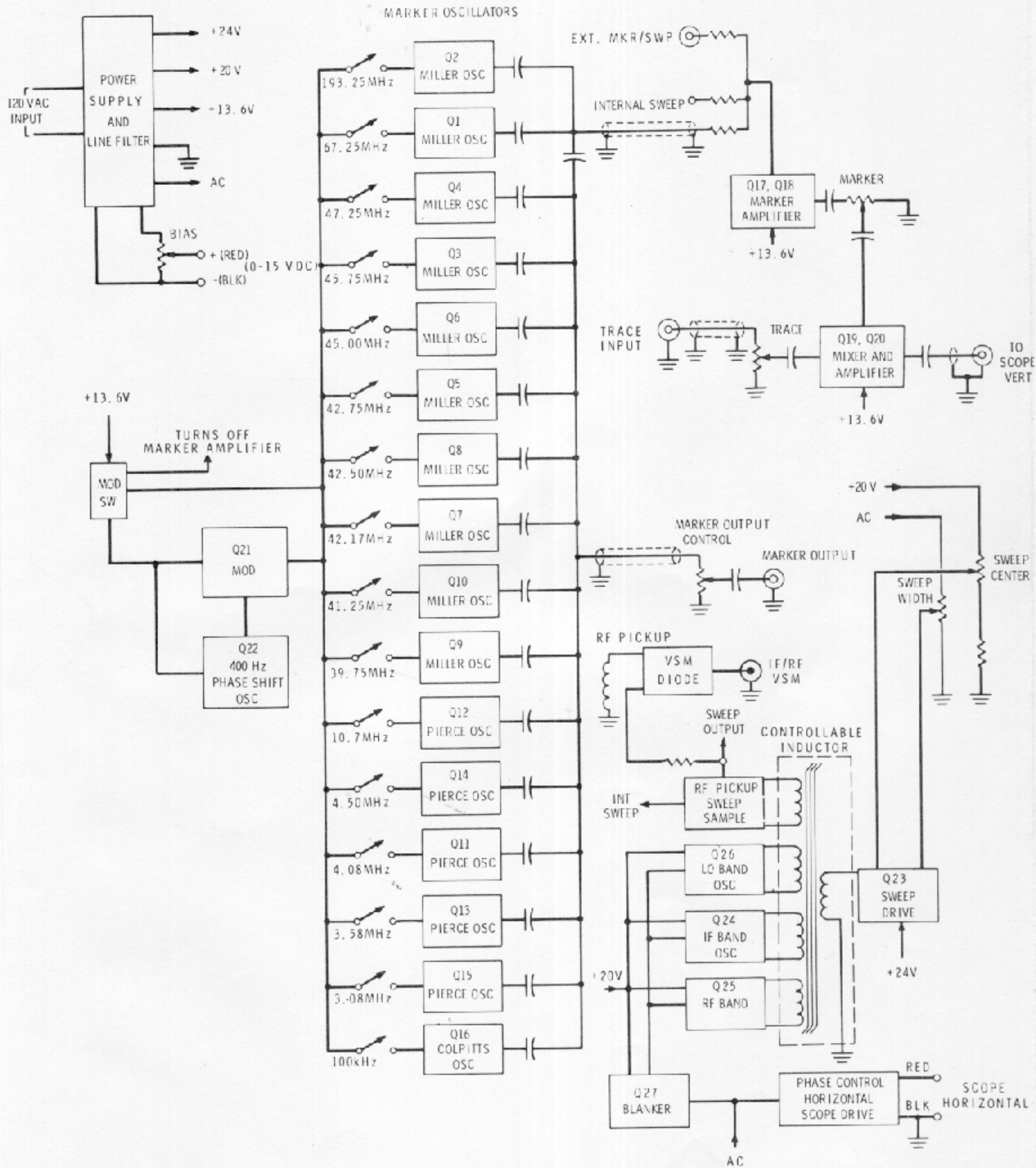

BLOCK DIAGRAM

Miller Oscillator

The Miller oscillators generate all the RF outputs above and including 39.75 MHz. These oscillators operate with third overtone crystals and fifth overtone crystals. They are all identical in operation, but have slightly different values depending upon the frequency of oscillation. The oscillator is basically a tuned-base tuned-collector circuit, with the crystal used as the tuned-base circuit. The tuned-collector circuit is a parallel resonant LC circuit, which is tunable to adjust the output amplitude of the oscillator. In all of the Miller oscillators, except Q2, the collector circuit is tuned to the crystal frequency. The 193.25 MHz output produced by Q2 is the second harmonic of the 96.625 MHz fifth overtone crystal used in the base circuit. The 193.25 MHz output is obtained by tuning the collector circuit of Q2 to the second harmonic, operating the stage as a frequency doubler. The oscillator outputs are capacitively coupled to the common RF output buss from the emitter load resistor on all the Miller oscillators except Q1.

Pierce Oscillator

The Pierce oscillator circuits generate all the frequencies below and including 10.7 MHz, except for the 100 kHz oscillator. These oscillators use crystals operating on their fundamental frequency, and are basically crystal versions of a Colpitts oscillator. The crystal is the feedback element from collector-to-base and operates inductively. The oscillator output is capacitively coupled from the collector to the RF buss. The Pierce oscillators are not tunable.

The Colpitts oscillator (Q16) generates the 100 kHz output. This oscillator is not crystal controlled. A parallel-resonant LC tank in the collector circuit determines the output frequency of the Colpitts oscillator. The collector-to-emitter feedback from the tapped capacitors in the tank circuit maintains the oscillation of the circuit and its output is capacitively coupled from the base to the RF buss. The coil in the tank circuit is adjusted to tune the oscillator to 100 kHz.

Marker Amplifier

A marker is produced by beating an RF signal (CW) from a marker oscillator with the sweep signal from the sweep section of the Generator.

When the sweep signal passes through its sweep range and an RF signal is present in that range, the two frequencies beat together and produce a marker or "birdie". Sum and difference frequency markers are also produced, but normally fall outside the frequency range being swept. They may appear on some traces, however, depending upon the frequencies involved.

The marker amplifier consists of two stages (Q17 and Q18) which operate as conventional common-emitter class A amplifiers in cascade, with RC coupling between stages. The input to the first stage (Q17) is a composite signal composed of the signal from the marker oscillator selected, and the signal from the sweep section of the Generator. The marker oscillator signal is applied through isolating resistor R86 and the sweep signal through isolating resistor R87 to Q17 where they are mixed. (NOTE: An external sweep or marker signal would be applied through isolating resistor R89 to the same point.) The resulting composite signal is then capacitively coupled to the base of Q17 where it is amplified and coupled to Q18 which further amplifies the signal. The output at the collector of Q18 is capacitively coupled to the Marker control. A portion of the amplified signal is applied to the Mixer/Trace amplifier circuit of Q19 and Q20.

Demodulation Mixer and Amplifier

The input signal to this circuit is supplied by the receiver under test. This demodulated signal is fed through the Trace Input jack and appears across the Trace control. A portion of this signal is capacitively coupled to the base of Q19. The mixer and amplifier circuit consists of Q19 and Q20 connected in a compound configuration similar to a Darlington pair. The Darlington configuration results in a high input impedance. The circuit functions as a compound emitter follower, with an output current approximately equal to the sum of the currents in the individual transistors.

The marker and sweep signal is injected at the base of Q20, where it is mixed with the demodulated input signal. The amplifier output is capacitively coupled from the collector of Q20 to the Scope Vertical jack for viewing with an oscilloscope.



Modulator Circuit

The modulator circuit consists of Mod switch S18, oscillator Q22 and modulator Q21. With the Mod switch in the On position, a DC voltage is applied through resistor R110 and through Mod switch S18 to the collector of Q21. Resistor R104 sets the bias of modulator Q21. The frequency of oscillation of 400 Hz oscillator Q22 is determined by the values of R and C in the collector-to-base circuit. These values are proportioned so the total phase shift from collector output to base input is 180 degrees at the modulating frequency of approximately 400 Hz.

The 400 Hz signal at the collector of Q22 is applied to the base of modulator Q21. This stage is basically an emitter follower using the sixteen Marker oscillators as its emitter load. The 400 Hz signal at the base of Q21 effectively varies the emitter-to-collector impedance at a 400 Hz rate. Since this varying impedance is in series with the DC voltage applied to the marker oscillators, the DC voltage will vary at a corresponding rate. Therefore, the RF output of the marker oscillators will vary in amplitude at a 400 Hz rate.

With the Mod switch turned on, marker amplifier Q18 is biased to cut off by resistor R109. Therefore, no markers will appear on the oscilloscope trace.

SWEEP GENERATOR

Refer to the Block Diagram (fold-out from Page 96), the Sweep Generator portion of the Schematic (fold-out from Page 117) and to Figure 25 while you read the following Circuit Description.

The heart of the sweep generator is the controllable inductor, L15. This is an electrical device in which the inductance of several oscillator coils is determined by the current in the control winding.

A DC current in the control winding will cause a magnetizing force to change the core flux density, which is the ratio of flux to the cross-sectional area of the core. An increased current will increase the magnetizing force and the flux density. As the flux density approaches a saturated condition, the core permeability, which is the ratio of flux density to the applied magnetizing force, decreases.

The individual oscillator coils are wound on small toroid cores tightly coupled to the U-shaped core. The inductance of these oscillator coils is determined by the permeability of the ferrite core material. Therefore, when the permeability of the core decreases, the oscillator coil inductance decreases and the oscillator frequency increases. Biasing the core near saturation and applying a 60 Hz current to the control winding will then cause the oscillator coil inductance and the oscillator frequency to vary at a 60 Hz rate.

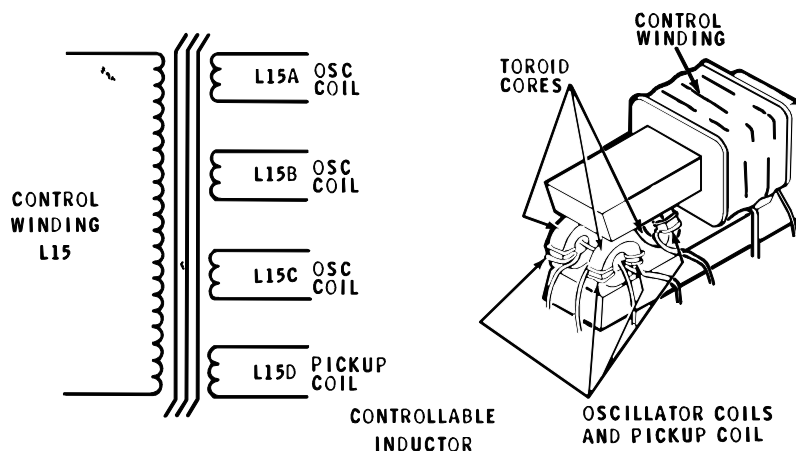

Figure 25



A similar effect occurs when the iron slug in a tuning coil is adjusted. Changing the position of the slug is like changing the control winding current.

The control winding (L15) is in the emitter circuit of sweep drive transistor Q23. LO, IF, and RF oscillator coils L15A, L15B, and L15C are in the collector circuit of transistors Q26, Q24, and Q25 respectively. Pickup winding L15D is common to both the sweep output circuit of the sweep generator and the input circuit (point V) of the Generator's marker amplifier circuit.

Sweep Drive Circuit

Sweep drive transistor Q23 controls the excitation current through the control winding of inductor L15. Control winding DC bias, which determines the center frequency of each sweep oscillator, is applied by Sweep center control R202 through resistors R209 and R215 to the base of transistor Q23. Resistor R204 provides a low limit of the center sweep frequency.

Resistor R210 and capacitor C211 couple 60 Hz AC from the Sweep Width control R203 to the base of transistor Q23. This AC signal voltage determines the overall sweep width or frequency deviation each side of the center frequency as determined by the setting of the Sweep Center control. Capacitor C211 also acts to block the DC voltage at the base of Q23 from being applied to the Sweep Width control. Capacitor C209 prevents AC voltages from appearing on the Sweep Center control. These capacitors prevent interaction between the Sweep Center and Sweep Width control functions.

Resistor R205 provides sweep limiting on the LO Sweep Range. Capacitors C200 through C207 are bypass capacitors to keep any unwanted RF from being fed back into the marker or power supply circuits of the Generator. All unwanted RF is contained within the sweep shield.

Blanking Circuit

In operation, the frequency of a sweep oscillator varies up and down between the low and high limits of its sweep range. This will result in a trace on the oscilloscope screen during the low to high frequency sweep and a second return trace during the high to low frequency sweep. The blanking circuit eliminates this return trace by driving the base-emitter voltage of each oscillator negative until the circuit stops oscillating. A square wave produced by blanking transistor Q27 is used for this purpose. The square wave is resistively coupled to the oscillator transistor through resistors R216, R218, and R220 respectively.

With the Blanking switch in the On position, an AC voltage of sufficient amplitude is applied from point D of the Generator's power supply circuit to the base of transistor Q27, alternately driving this stage from saturation to cutoff and creating a square wave at its collector. In the saturated state, the collector-to-emitter voltage of Q27 drops to only a few tenths of a volt. This low voltage is then applied through resistors R216, R218, and R220 to the base of transistors Q26, Q24, and Q25 respectively, causing the base voltage of these three oscillator transistors to decrease to a value which stops oscillation. The time constants are such that oscillation is stopped during the return trace time, which eliminates the return trace. Diode D4 protects transistor Q27 from large negative pulses and makes the on-time and off-time nearly equal, which produces a symmetrical square wave.

When Q27 is in its cutoff state, the base voltage of the three oscillator transistors will be normal. They will then oscillate and the forward trace will appear on the oscilloscope screen. The screen will also show a base reference line when the Blanking switch is on.



Oscillator Circuits

There are three oscillators: Q26 for LO band operation, Q24 for IF band operation, and Q25 for RF band operation. Each oscillator is a modified Colpitts type whose frequency is caused to sweep through a range determined by the controllable inductor winding (oscillator coil) in its collector circuit. Since the three oscillators operate in the same manner, only IF Band oscillator Q24 will be described here. The Sweep Range switch selects the desired range by applying operating voltage to the circuit of the selected sweep oscillator.

The IF Band oscillator circuit of transistor Q24 produces a range of frequencies from 38 to 48 MHz that are used in aligning the IF circuits in television receivers. Trimmer capacitor C219, capacitor C220, and coil L15B of the controllable inductor comprise the resonant tank circuit of the IF Band oscillator. NOTE: The IF and the RF Band oscillators use variable trimmer capacitors C219 and C223 in their resonant tank circuits, while the LO Band oscillator uses fixed capacitor C215 in its resonant tank circuit. Resistors R212 and R219 set the DC bias point of the circuit. Capacitors C217 and C218 provide RF bypassing.

The coil shown in the Schematic as L15D is a loop of wire which passes through the toroid cores of oscillator coils L15A, L15B, and L15C. This pickup loop couples the output signal of each sweep oscillator through capacitor C225 to the Sweep Output jack. A small portion of this signal is also coupled through the RC divider network of R223, C226, and R224 to point V on the Generator's amplifier circuit board. These sweep signals are then applied through resistor R87 to the input circuit of Marker Amplifier transistor Q17. Resistor R222 provides correct impedance match to the 75 ohm coaxial cable to the Sweep Output jack.

Phase Adjust control R225 and capacitor C228 are connected in series across the secondary winding of power transformer T1. The RC network of resistors R226, R227, and capacitor C229 in the Generator's scope horizontal circuit provide the necessary phase shift. Phase control R225 adjusts the degree of phase shift introduced so the sweep drive voltage at the Sweep Output jack and the deflection voltage at the

Scope Horizontal binding posts are in phase. Trace Reverse switch S20 reverses the effective polarity of the phasing voltage that appears at the Scope Horizontal binding posts. This allows the waveforms on the oscilloscope screen to be presented so the markers and the trace will appear as shown in the TV set alignment instructions.

VSM CIRCUIT

Diode Modulator (Video Sweep Modulator)

Diode D5 is operated as a series modulator. As either video carrier frequency (45.75 or 67.25) is turned on, pick up coil L17, (the length of wire connected to solder lug CC) supplies the carrier to the anode. When a sweep modulating signal is applied through R249 to the cathode, the output will consist of the carrier, the sum and difference frequencies of the carrier, and the sweep modulating signals. The upper sideband will consist of the sum frequencies, and the lower sideband will consist of the difference frequencies. The width of each sideband will depend on the sweep signal width.

In a TV receiver, the IF section will suppress the upper sideband, and the video detector diode will suppress the video carrier. The detected envelope of the lower sideband is applied to the color bandpass (and video) output amplifiers.

The modulated signal is tuned by L16 and C231. C232 couples the output signal to terminating resistor R251 and the IF/RF VSM output.

Attenuation

A seven-step attenuator is provided in order to attenuate the Sweep Output signals as necessary during the alignment procedure. The proper impedance match will be maintained between the coaxial RF cable and the signal injection point in the TV receiver regardless of the signal attenuation introduced. With an Attenuator rocker switch turned on (to the IN position), two shunt resistors and one series resistor provide the attenuation indicated above the rocker switch. The attenuation is additive as each rocker switch is placed to the IN position. With all seven switches in the IN position, a total of 70 dB attenuation is obtained.



POWER SUPPLY

The power supply circuit operates from a 120 volt, 60 Hz AC source and produces three voltage outputs. The AC input is applied through an LC pi-type filter which consists of capacitors C69, C71, C72, C73, and chokes L12 and L13. This filter prevents RF from being radiated back into the power line. A switch (S17) applies the AC line voltage to the primary winding of power transformer T1. A neon indicator lamp connected across the primary winding will light when switch S17 is turned on.

Transformer T1 is a step-down transformer with two secondary windings. Winding #1 is center tapped and is connected in a conventional full-wave circuit using diodes D1 and D2 as rectifiers. The rectifier output is filtered by an RC pi-type filter consisting of capacitor C76, resistor R84, and capacitor C77. The filtered DC is applied through current limiting resistor R85 to zener diode ZD1 which provides a regulated voltage of +13.6 volts DC for the Marker and Amplifier circuits of the Generator. The normal zener current for ZD1 with the markers off is 30 to 35 mA.

The rectified voltage at point L, which is approximately +24 volts DC, is applied through resistors R200 and R201 (see Sweep Generator Schematic) to zener diode ZD2, which provides a regulated voltage of +20 volts DC. This regulated voltage is applied to the Blanking, Oscillator, and Sweep Drive control circuits of the Generator. The full +24 volts DC unregulated output of the power supply is applied through resistor R200 to the collector circuit of sweep drive transistor Q23.

Transformer secondary winding #2 is connected in a conventional half-wave circuit using diode D3 as its rectifier. The output of this rectifier is applied to an RC pi-type filter consisting of C74, R83, and C75, whose filtered DC output voltage is applied across Bias switch S22. With this switch in the (+) position, the circuit board terminal K is grounded and positive voltage is applied to the Bias controls R82 and R113 from point J. In the (-) position point J is grounded and negative voltage is applied to Bias controls from point K. R111 and R112 provide the current limiting.



*Blank
Page*



EXTERNAL GENERATOR

REQUIREMENTS

An exterior sweep and/or marker generator may be used with the Model IG-57A Post-Marker/Sweep Generator. To provide a variable marker from an RF signal generator (or fixed markers from a marker generator), connect the generator output to the EXTERNAL MKR/SWP input jack. Keep the signals low.

For external sweep signal injection, a constant amplitude sample sweep signal is required. This signal should be between .04 and .05 volts at all frequencies.

If a Heathkit Model TS-4, TS-4A, or IG-52 Television Alignment Generator is to be used as an external signal source, its circuits must be modified as follows:

1. A panel jack must be installed and connected to a point in the circuit where the output signal is constant in amplitude.
2. The low frequency oscillator circuit must be modified to produce a sweep range low enough to include the frequencies necessary to properly align the color bandpass circuits in a color TV receiver.
3. The power supply circuit should be modified if the lower frequency markers appear on the right-hand instead of the left-hand portion of the oscilloscope waveform.

The following modification procedures apply specifically to Heathkit Models TS-4, TS-4A, and IG-52 Generators. These same modifications will apply to many other makes of generators. Refer to the Schematic Diagram and Instruction Manual for your generator to determine how the modification is to be accomplished.

NOTE: The parts required for the following modification procedures are not furnished with this kit. They may be obtained from a local source.

MODIFICATION FOR CONSTANT SIGNAL AMPLITUDE

- () Remove the generator from its case.
- () Locate the Fine Attenuator Adjust control and the RF output jack. NOTE: If the RF attenuator on your generator is shielded, drill a hole through the shield. Then use a length of 75 Ω coaxial cable to feed the signal out of the attenuator. The shield lead of the coaxial cable should be grounded at both ends.
- () Drill a 1/4" hole through the front panel close to the RF attenuator control. Try to position the hole on the same horizontal plane as the surrounding controls and connectors.



- () Refer to Figure 26 and mount a phono socket as shown.

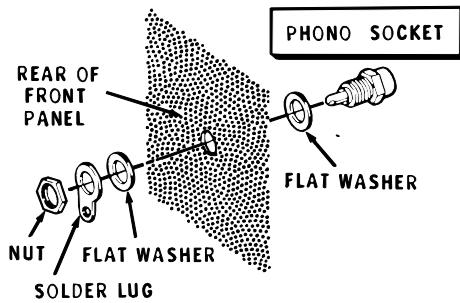

Figure 26

- () Refer to Figure 27 to find where the lug for the "high side" of the attenuator control is located.
- () Connect a 1000 Ω (brown-black-red) resistor from the "high side" lug of the attenuator control (S-1) to the center lug of the phono socket (NS).
- () Connect a 75 Ω (violet-green-black) resistor from the center lug of the phono socket (S-2) to the ground lug of the phono socket (NS).
- () Connect a ground wire from the solder lug of the phono socket (S-2) to the ground lug of the RF Output connector (S-1).

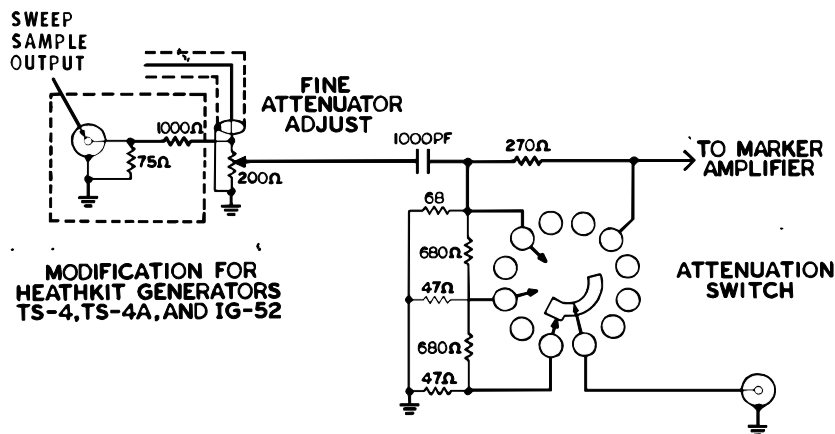

Figure 27

MODIFYING LOW FREQUENCY OSCILLATOR

NOTE: The sweep range of some generators is not low enough to cover the color bandpass range of a color TV receiver. The sweep range of the generator can be lowered by adding a capacitor across the low frequency band oscillator coil in the generator.

- () Refer to Figure 28 for the oscillator coil circuitry of the Heathkit Models TS-4, TS-4A, and IG-52 Television Alignment Generators.

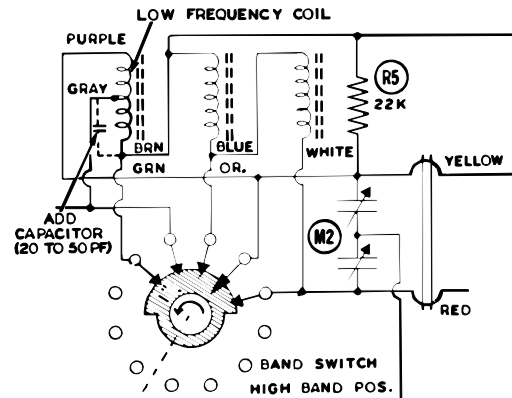

Figure 28

- () Connect a 20 to 50 pF capacitor across the low frequency oscillator coil as shown. This will lower the frequency range of these generators.

MODIFYING POWER SUPPLY CIRCUIT

NOTE: If the lower frequency markers appear on the right-hand instead of the left-hand portion of the oscilloscope waveform, perform the following steps.

- () Locate the red leads of the power transformer that are connected to lug 6 and lug 1 of tube socket A. This is the 6x4 rectifier tube socket.
- () Reverse the connection of these two red leads as shown in Figure 29. This will reverse the sweep so the markers will appear on the correct portion of the waveform.

This completes the modification procedure.

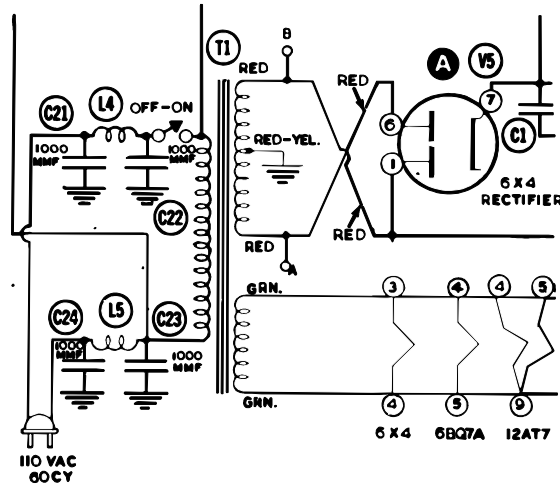

Figure 29

CONNECTING EXTERNAL GENERATORS

Connect the external sweep generator to the Generator as shown in Figure 30.

To connect both an external sweep generator and a variable (or fixed) marker generator to your Generator, change the input to the EXTERNAL/MKR/SWP jack as shown in Figure 30A.

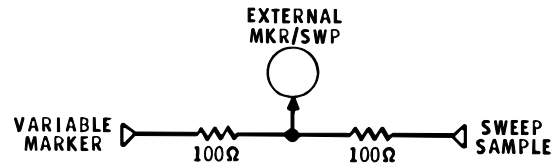

Figure 30A

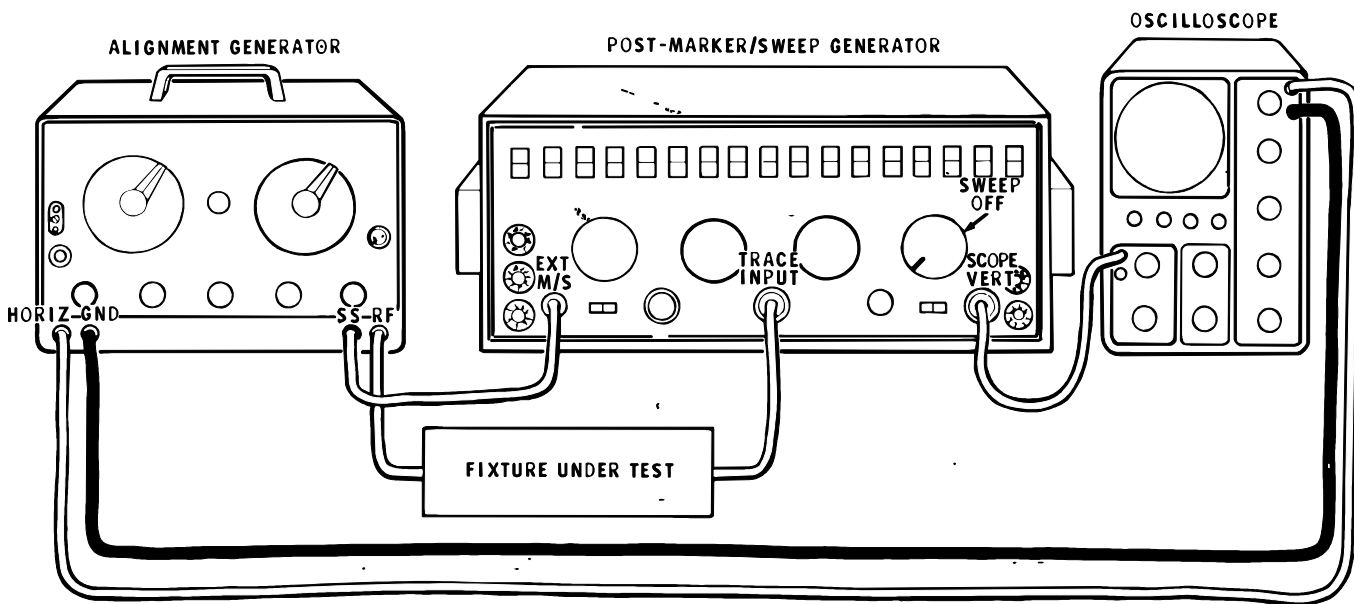

Figure 30

U.S. TELEVISION CHANNEL FREQUENCIES
45.75 Pix I.F.

CHANNEL	BAND	CENTER FREQ.	PIX CARRIER	SOUND CARRIER	OSC. FREQ.	PIX IMAGE FREQ.	CHANNEL	BAND	CENTER FREQ.	PIX CARRIER	SOUND CARRIER	OSC. FREQ.	PIX IMAGE FREQ.
2	54 - 60	57	55.25	59.75	101	146.75	43	644 - 650	647	645.25	649.75	691	736.75
3	60 - 66	63	61.25	65.75	107	152.75	44	650 - 656	653	651.25	655.75	697	742.75
4	66 - 72	69	67.25	71.75	113	158.75	45	656 - 662	659	657.25	661.75	703	748.75
5	76 - 82	79	77.25	81.75	123	168.75	46	662 - 668	665	663.25	667.75	709	754.75
6	82 - 88	85	83.25	87.75	129	174.75	47	668 - 674	671	669.25	673.75	715	760.75
7	174 - 180	177	175.25	179.75	221	266.75	48	674 - 680	677	675.25	679.75	721	766.75
8	180 - 186	183	181.25	185.75	227	272.75	49	680 - 686	683	681.25	685.75	727	772.75
9	186 - 192	189	187.25	191.75	233	278.75	50	686 - 692	689	687.25	691.75	733	778.75
10	192 - 198	195	193.25	197.75	239	284.75	51	692 - 698	695	693.25	697.75	739	784.75
11	198 - 204	201	199.25	203.75	245	290.75	52	698 - 704	701	699.25	703.75	745	790.75
12	204 - 210	207	205.25	209.75	251	296.75	53	704 - 710	707	705.25	709.75	751	796.75
13	210 - 216	213	211.25	215.75	257	302.75	54	710 - 716	713	711.25	715.75	757	802.75
14	470 - 476	473	471.25	475.75	517	562.75	55	716 - 722	719	717.25	721.75	763	808.75
15	476 - 482	479	477.25	481.75	523	568.75	56	722 - 728	725	723.25	727.75	769	814.75
16	482 - 488	485	483.25	487.75	529	574.75	57	728 - 734	731	729.25	733.75	775	820.75
17	488 - 494	491	489.25	493.75	535	580.75	58	734 - 740	737	735.25	739.75	781	826.75
18	494 - 500	497	495.25	499.75	541	586.75	59	740 - 746	743	741.25	745.75	787	832.75
19	500 - 506	503	501.25	505.75	547	592.75	60	746 - 752	749	747.25	751.75	793	838.75
20	506 - 512	509	507.25	511.75	553	598.75	61	752 - 758	755	753.25	757.75	799	844.75
21	512 - 518	515	513.25	517.75	559	604.75	62	758 - 764	761	759.25	763.75	805	850.75
22	518 - 524	521	519.25	523.75	565	610.75	63	764 - 770	767	765.25	769.75	811	856.75
23	524 - 530	527	525.25	529.75	571	616.75	64	770 - 776	773	771.25	775.75	817	862.75
24	530 - 536	533	531.25	535.75	577	622.75	65	776 - 782	779	777.25	781.75	823	868.75
25	536 - 542	539	537.25	541.75	583	628.75	66	782 - 788	785	783.25	787.75	829	874.75
26	542 - 548	545	543.25	547.75	589	634.75	67	788 - 794	791	789.25	793.75	835	880.75
27	548 - 554	551	549.25	553.75	595	640.75	68	794 - 800	797	795.25	799.75	841	886.75
28	554 - 560	557	555.25	559.75	601	646.75	69	800 - 806	803	801.25	805.75	847	892.75
29	560 - 566	563	561.25	565.75	607	652.75	70	806 - 812	809	807.25	811.75	853	898.75
30	566 - 572	569	567.25	571.75	613	658.75	71	812 - 818	815	813.25	817.75	859	904.75
31	572 - 578	575	573.25	577.75	619	664.75	72	818 - 824	821	819.25	823.75	865	910.75
32	578 - 584	581	579.25	583.75	625	670.75	73	824 - 830	827	825.25	829.75	871	916.75
33	584 - 590	587	585.25	589.75	631	676.75	74	830 - 836	833	831.25	835.75	877	922.75
34	590 - 596	593	591.25	595.75	637	682.75	75	836 - 842	839	837.25	841.75	883	928.75
35	596 - 602	599	597.25	601.75	643	688.75	76	842 - 848	845	843.25	847.75	889	934.75
36	602 - 608	605	603.25	607.75	649	694.75	77	848 - 854	851	849.25	853.75	895	940.75
37	608 - 614	611	609.25	613.75	655	700.75	78	854 - 860	857	855.25	859.75	901	946.75
38	614 - 620	617	615.25	619.75	661	706.75	79	860 - 866	863	861.25	865.75	907	952.75
39	620 - 626	623	621.25	625.75	667	712.75	80	866 - 872	869	867.25	871.75	913	958.75
40	626 - 632	629	627.25	631.75	673	718.75	81	872 - 878	875	873.25	877.75	919	964.75
41	632 - 638	635	633.25	637.75	679	724.75	82	878 - 884	881	879.25	883.75	925	970.75
42	638 - 644	641	639.25	643.75	685	730.75	83	884 - 890	887	885.25	889.75	931	976.75

CHASSIS PHOTOGRAPHS

R78 S21 R203 R202 R79 R81 R108 R113 R82 R80 R110

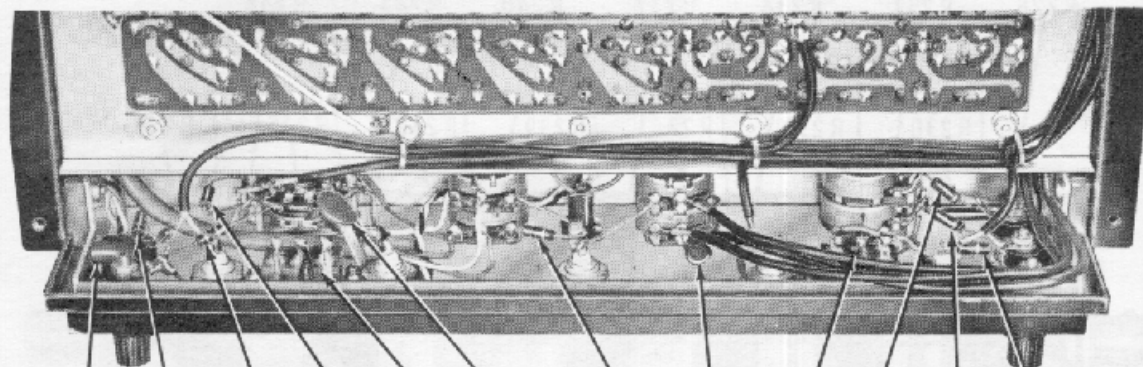
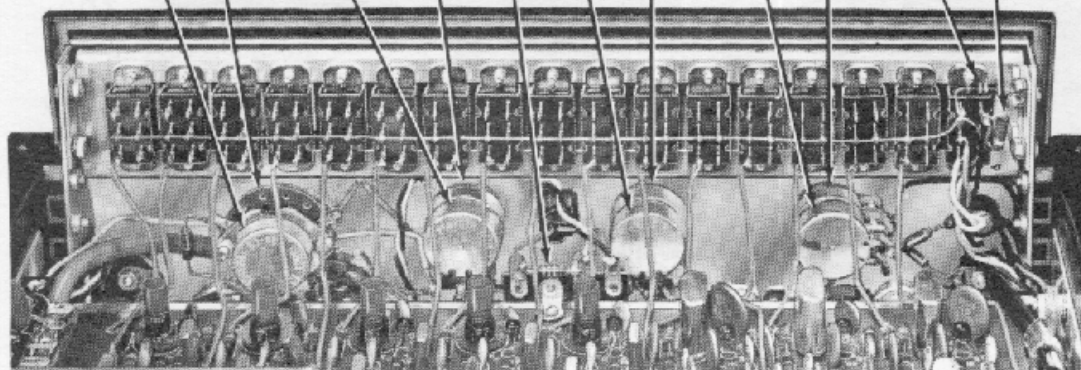

C229 R227 R206 R205 S17 C68 R204 C94 S22 R112 R111 R90

HEATHKIT®

107



created using
BCL easyPDF
Printer Driver

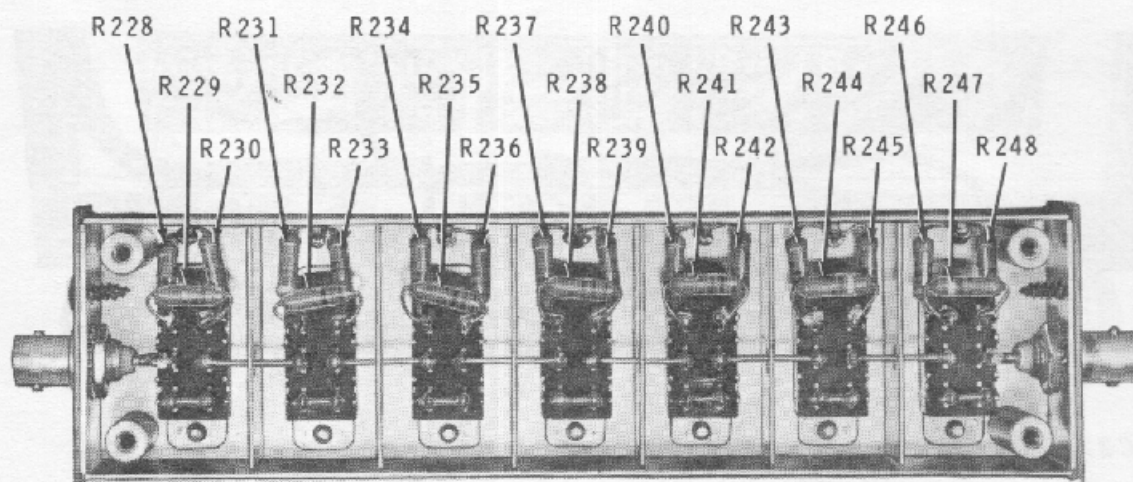
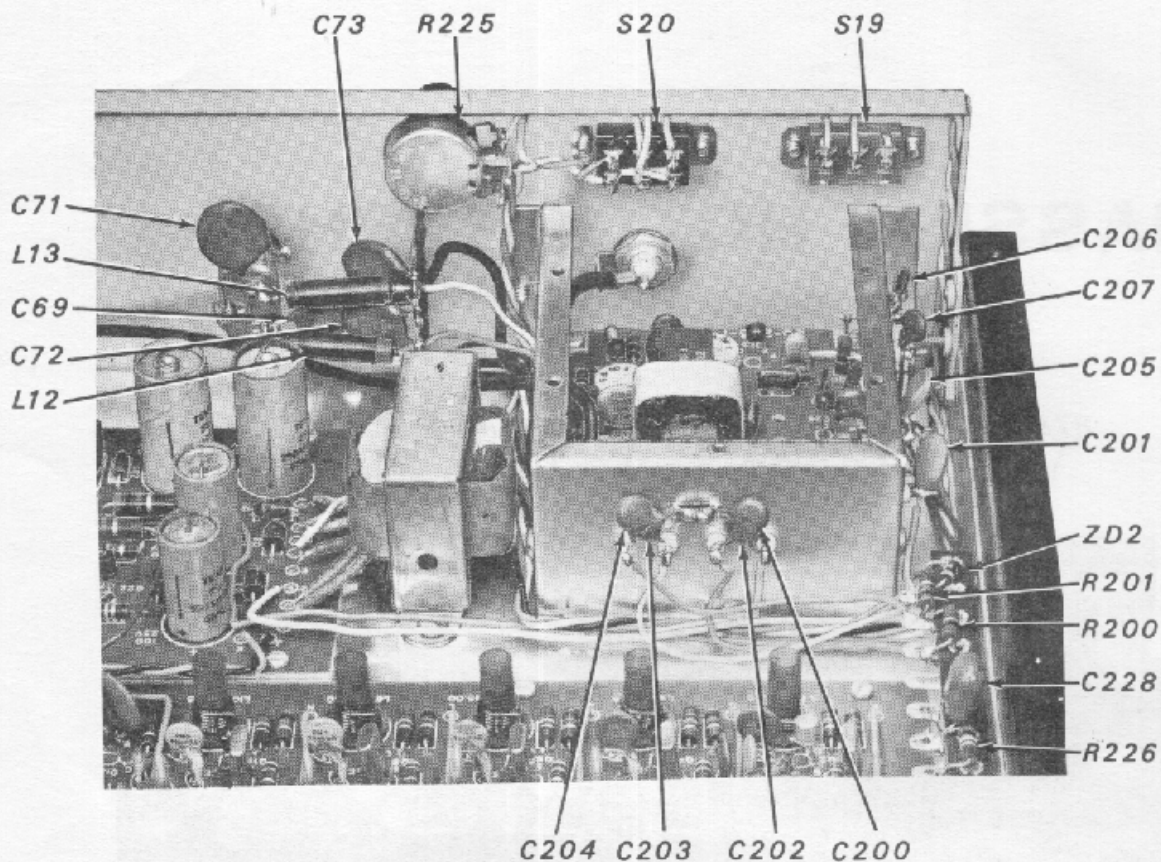

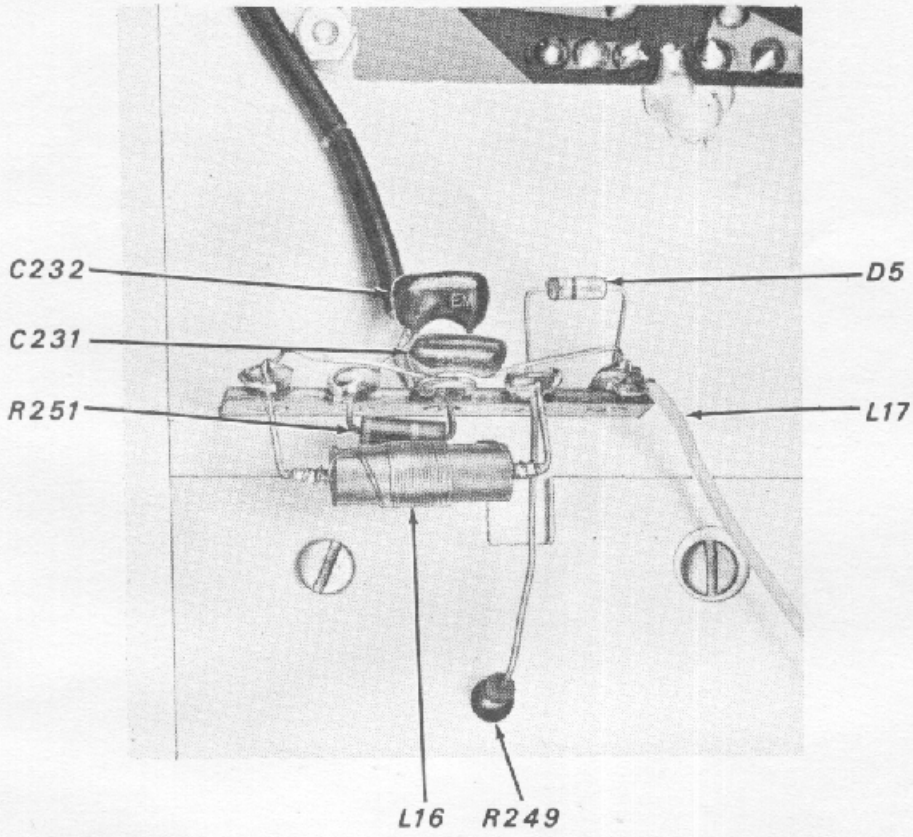

Blank
Page



CIRCUIT BOARD X-RAY VIEWS

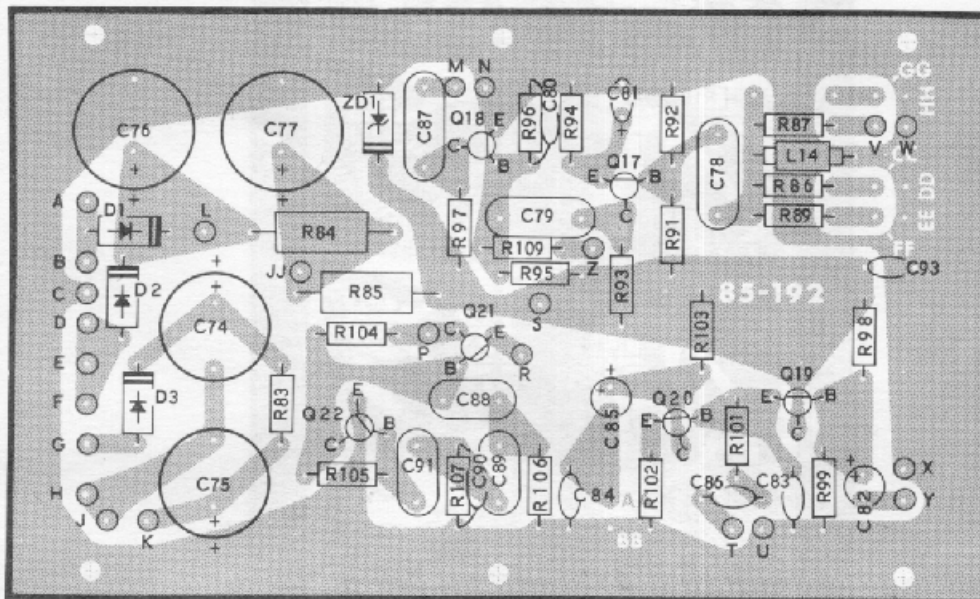

AMPLIFIER CIRCUIT BOARD
(VIEWED FROM FOIL SIDE)

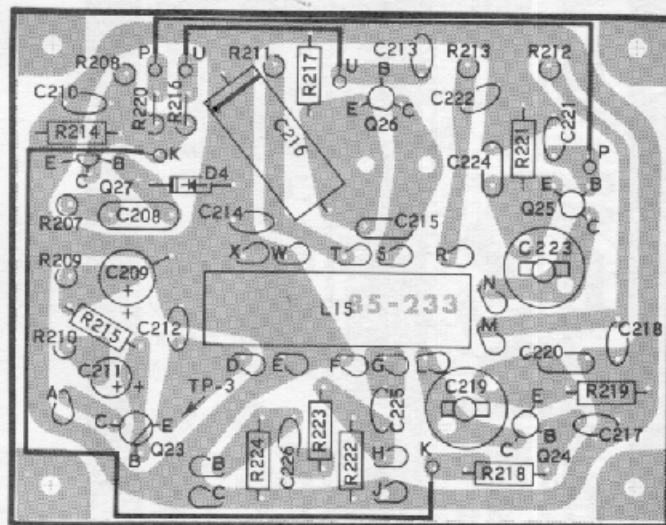

SWEEP CIRCUIT BOARD
(VIEWED FROM FOIL SIDE)

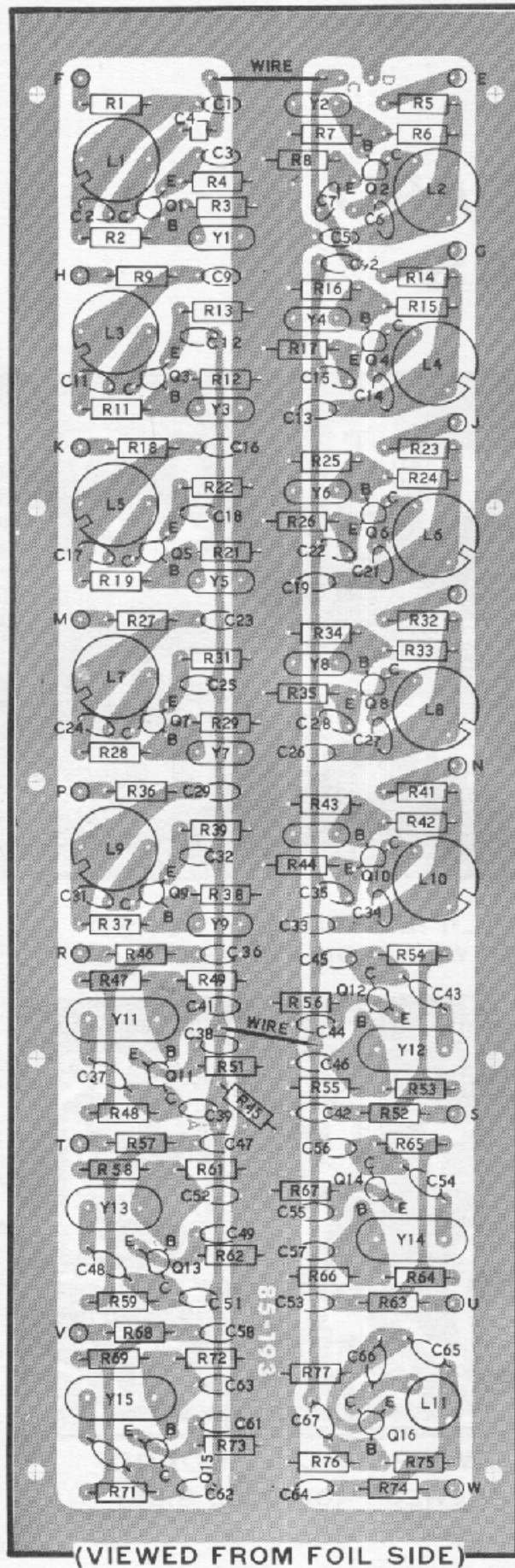

(VIEWED FROM FOIL SIDE)

OSCILLATOR CIRCUIT BOARD

REPLACEMENT PARTS PRICE LIST

To order parts, use the Parts Order Form furnished with this kit. If a Parts Order Form is not available, refer to Replacement Parts in the Kit Builders Guide.

The following prices apply only on purchases from the Heath Company where shipment is to a

U.S.A. destination. Add 10% (minimum 25 cents) to the price when ordering from an authorized Service Center or Heathkit Electronic Center to cover local sales tax, postage and handling. Outside the U.S.A. parts and service are available from your local Heathkit source and will reflect additional transportation, taxes, duties and rates of exchange.

<u>PART No.</u>	<u>PRICE Each</u>	<u>DESCRIPTION</u>
-----------------	-------------------	--------------------

RESISTORS

1/2 Watt

1-130	.10	8.2 Ω
1-49	.10	22 Ω
1-146	.10	75 Ω
1-3	.10	100 Ω
1-66	.10	150 Ω
1-45	.10	220 Ω
1-42	.10	270 Ω
1-6	.10	470 Ω
1-7	.10	680 Ω
1-9	.10	1000 Ω
1-11	.10	1500 Ω
1-44	.10	2200 Ω
1-13	.10	2700 Ω
1-16	.10	4700 Ω
1-19	.10	6800 Ω
1-73	.10	8200 Ω
1-20	.10	10 kΩ
1-109	.10	12 kΩ
1-21	.10	15 kΩ
1-22	.10	22 kΩ
1-23	.10	27 kΩ

<u>PART No.</u>	<u>PRICE Each</u>	<u>DESCRIPTION</u>
-----------------	-------------------	--------------------

1/2 Watt (cont'd.)

1-67	.10	39 kΩ
1-25	.10	47 kΩ
1-47	.10	56 kΩ
1-60	.10	68 kΩ
1-26	.10	100 kΩ
1-121	.10	120 kΩ
1-31	.10	330 kΩ
1-32	.10	390 kΩ
1-37	.10	2.2 MΩ

1/2 Watt Low-Noise

4-69	.10	27 Ω, 5%
4-70	.10	56 Ω, 5%
4-9	.10	91 Ω, 5%
4-57	.10	100 Ω, 5%
4-58	.10	150 Ω, 5%
4-59	.10	220 Ω, 5%
4-12	.10	390 Ω, 5%
4-71	.10	430 Ω, 5%
4-72	.10	1300 Ω, 5%

1 Watt

1-17-1	.10	100 Ω
--------	-----	-------



PART No.	PRICE Each	DESCRIPTION
----------	------------	-------------

CAPACITORS**Disc**

21-3	.10	10 pF
21-60	.10	18 pF
21-84	.10	24 pF
21-7	.10	33 pF
21-32	.10	47 pF
21-85	.10	56 pF
21-96	.10	85 pF
21-9	.10	100 pF
21-11	.10	150 pF
21-21	.10	200 pF
21-17	.10	270 pF
21-56	.10	470 pF
21-13	.10	500 pF
21-14	.10	.001 μ F
21-26	.10	.003 μ F
21-27	.10	.005 μ F
21-72	.10	.005 μ F, 1.4 kV (1400 V)
21-47	.10	.01 μ F

Electrolytic

25-149	.50	5 μ F
25-115	.40	10 μ F
25-145	.50	25 μ F
25-194	.50	100 μ F
25-193	.60	250 μ F

Other Capacitors

28-2	.10	1 pF phenolic
20-99	.15	22 pF resin
20-124	.15	115 pF resin
20-104	.15	130 pF resin
20-107	.40	680 pF resin
29-8	.15	3300 pF
27-73	.15	.047 μ F Mylar
27-47	.20	.1 μ F Mylar
25-200	.50	.68 μ F, 35 V Tantalum
31-36	.85	8 to 50 pF trimmer

COILS-CHOKES-INDUCTOR-TRANSFORMER

40-478	.25	Oscillator coil (brown)
40-479	.30	Oscillator coil (red)
40-820	.35	100 kHz oscillator coil
45-76	.20	1.2 μ H choke
45-39	.20	4.7 μ H choke
45-6	.25	8.2 μ H choke
403-3	6.40	Controllable inductor
54-191	2.65	Power transformer

PART No.	PRICE Each	DESCRIPTION
----------	------------	-------------

DIODES-TRANSISTORS

57-27	.50	Silicon diode
56-26	.25	Crystal diode
56-32	1.10	13.6 V zener diode
56-45	1.00	20 V zener diode
417-118	.40	2N3393 transistor
417-94	1.00	2N3416 transistor
417-108	.55	2N3692 transistor
417-133	1.30	40245 transistor

CRYSTALS

404-332	4.95	3.080 MHz
404-333	4.95	4.080 MHz
404-4	3.10	4.5 MHz (4500 kHz)
404-39	4.30	10.7 MHz
404-238	1.50	3.579 MHz (3579.545 kHz)
404-334	4.95	39.750 MHz
404-335	4.95	41.250 MHz
404-336	4.95	42.170 MHz
404-337	4.95	42.500 MHz
404-344	4.95	42.750 MHz
404-338	4.95	45.000 MHz
404-339	4.95	45.750 MHz
404-340	4.95	47.250 MHz
404-341	4.95	67.250 MHz
404-342	4.95	96.625 MHz

CONTROLS-SWITCHES

10-11	.50	50 k Ω control
12-92	1.70	5 k Ω /10 k Ω dual concentric control
12-91	1.70	10 k Ω /1 M Ω dual concentric control
12-102	1.50	20 k Ω /20 k Ω dual concentric control
63-483	3.40	Wafer switch with 100 Ω control
60-4	.20	Slide switch, SPDT
60-2	.30	Slide switch, DPDT
60-48	.55	Rocker switch, DPDT (RF)









PART No.	PRICE Each	DESCRIPTION	PART No.	PRICE Each	DESCRIPTION
CONNECTOR-PLUGS-INSULATORS-STRIPS			#6 Hardware		
432-76	.30	AC connector	250-116	.05	6-32 x 1/4" black screw
432-58	1.75	Coaxial plug	250-56	.05	6-32 x 1/4" screw
432-59	1.65	Coaxial connector	250-229	.05	6-32 x 1/4" phillips head screw
438-13	.15	Banana plug	250-303	.15	6-32 x 1/4" decorative head screw
70-5	.10	Plug insulator (black)	250-304	.15	6-32 x 7/16" spacer stud
70-6	.10	Plug insulator (red)	250-89	.05	6-32 x 3/8" screw
431-3	.10	3-lug terminal strip	250-162	.05	6-32 x 1/2" screw
431-11	.10	5-lug terminal strip	252-3	.05	6-32 nut
431-35	.10	7-lug terminal strip	250-8	.05	#6 x 3/8" sheet metal screw
431-73	.10	Terminal strip	250-155	.05	#6 x 3/8" black sheet metal screw
KNOBS-BUSHINGS			254-1	.05	#6 lockwasher
462-82	.20	Black knob	259-1	.05	#6 solder lug
462-247	.35	Concentric knob with pointer	Other Hardware		
455-52	.10	Bushing for knob #462-247	259-24	.05	#8 long lug
462-276	.25	Small knob with color dot	252-7	.05	Control nut
455-51	.10	Bushing for knob #462-276	254-4	.05	Control lockwasher
CABLE-WIRE-SLEEVING			259-10	.05	Control solder lug
347-1	.15/ft	8-wire cable	253-10	.05	Control flat washer
89-30	1.25	Line cord with plugs	255-21	.15	7/8" spacer
343-7	.05/ft	Small coaxial cable	252-9	.05	Speednut
343-9	.10/ft	Large coaxial cable	427-3	.10	Binding post base
341-1	.10/ft	Large black stranded wire	METAL PARTS		
341-2	.10/ft	Large red stranded wire	200-515	1.45	Chassis
344-50	.05/ft	Black wire	100-932	.40	Front panel
344-52	.05/ft	Red wire	100-947	1.40	Rear panel
344-53	.05/ft	Orange wire	90-374-1	4.95	Cabinet half-shell
344-54	.05/ft	Yellow wire	204-812	.65	Siderail
344-56	.05/ft	Blue wire	204-759-1	.15	End cap
344-59	.05/ft	White wire	204-811	.30	Switch bracket
340-3	.05/ft	Large bare wire	210-35	2.90	Bezel
HARDWARE			206-383	.90	Sweep shield
#4 Hardware			205-591	.25	Shield cover
250-52	.05	4-40 x 1/4" screw	205-727	.40	Shield plate
250-34	.05	4-40 x 1/2" screw	90-398-1	.80	Attenuator top shell
252-2	.05	4-40 nut	90-397	.55	Attenuator bottom shell
254-9	.05	#4 lockwasher	206-384	.75	Attenuator shield
			206-385	.15	Switch shield

<u>PARTS</u> <u>No.</u>	<u>PRICE</u> <u>Each</u>	<u>DESCRIPTION</u>	<u>PARTS</u> <u>No.</u>	<u>PRICE</u> <u>Each</u>	<u>DESCRIPTION</u>
MISCELLANEOUS			Miscellaneous (cont'd.)		
85-192-2	1.30	Amplifier circuit board	75-15	.30	Terminal shell (drilled)
85-193-3	2.20	Oscillator circuit board	75-106	.45	Terminal shell (RF)
85-233-1	1.00	Sweep circuit board	75-87	.20	Nylon feedthrough
73-34	.10	Clip insulator	204-135	.10	Angle bracket
75-17	.10	Insulator bushing	207-19	.10	5/16" cable clamp
100-16-2	.10	Black binding post cap	211-34	.50	Handle
100-16-18	.10	Red binding post cap	490-1	.10	Alignment tool
413-10	.10	Red lens	490-5	.10	Nut starter
412-15	.20	Neon lamp (NE2H)	432-27	.40	AC plug adapter
260-16	.10	Alligator clip		2.00	Manual (See front cover for part number.)
261-28	.05	Large plastic foot	331-6	.15	Solder
261-29	.05	Small plastic foot			
259-7	.05	Spade lug			
73-53	.10	Rubber grommet			
75-111	.45	Terminal shell (DEM0D)			





**SCHEMATIC OF THE
HEATHKIT®
T.V. POST-MARKER/SWEEP GENERATOR
MODEL IG-57A**

GENERAL NOTES

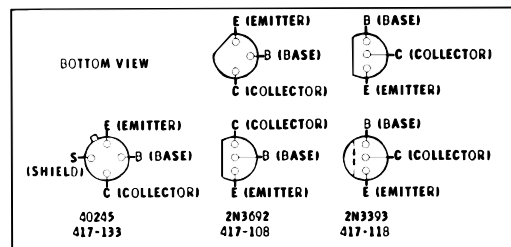
- 1 ALL RESISTORS ARE 1/2 WATT UNLESS MARKED OTHERWISE. RESISTOR VALUES ARE IN OHMS (K-1,000 M-1,000,000)
- 2 ALL CAPACITOR VALUES ARE IN μ F UNLESS MARKED OTHERWISE
- 3  INDICATES DC VOLTAGE MEASURED FROM THE POINT INDICATED TO GROUND. VOLTAGE READINGS TAKEN WITH AN 11 MEGOHM INPUT ELECTRONIC VOLTMETER. VOLTAGE MAY VARY $\pm 20\%$.
- 4 SWITCHES SHOWN IN THE OFF POSITION UNLESS OTHERWISE MARKED.
- 5 REFER TO THE CHASSIS PHOTOGRAPHS AND CIRCUIT BOARD X-RAY VIEWS FOR THE PHYSICAL LOCATION OF PARTS
- 6  THIS TYPE OF SYMBOL INDICATES LETTERED HOLE IN CIRCUIT BOARDS
- 7  THIS TYPE OF SYMBOL (WHITE LETTER ON BLACK BACKGROUND) INDICATES LETTERED HOLE IN AMPLIFIER CIRCUIT BOARD IN WHICH LEADS FROM SWEEP GENERATOR CIRCUIT ARE CONNECTED.
- 8  INDICATES FEED-THROUGH ON SWEEP SHIELD
- 9  INDICATES COMMON FOIL CONNECTION ON CIRCUIT BOARDS
- 10  INDICATES CHASSIS GROUND.
- 11  INDICATES WINDING ON CONTROLLABLE INDUCTOR
- 12 TRANSISTOR LEAD IDENTIFICATION:

**SPECIAL NOTES**

- 1 WHEN MAKING SWEEP GENERATOR VOLTAGE MEASUREMENTS
 - A PLACE BLANKING SWITCH IN THE ON POSITION
 - B TURN THE OTHER CONTROLS TO THE 12 O'CLOCK POSITION
 - C ADJUST SWEEP CENTER CONTROL UNTIL VOLTAGE AT TP-3 (E OF Q23) IS 12.0 DC
- 2 OSCILLATOR VOLTAGE READINGS.
 - Q26 *  (SWEEP RANGE SWITCH IN LO POSITION)
 - Q24 * *  (SWEEP RANGE SWITCH IN IF POSITION)
 - Q25 * * *  (SWEEP RANGE SWITCH IN RF POSITION).

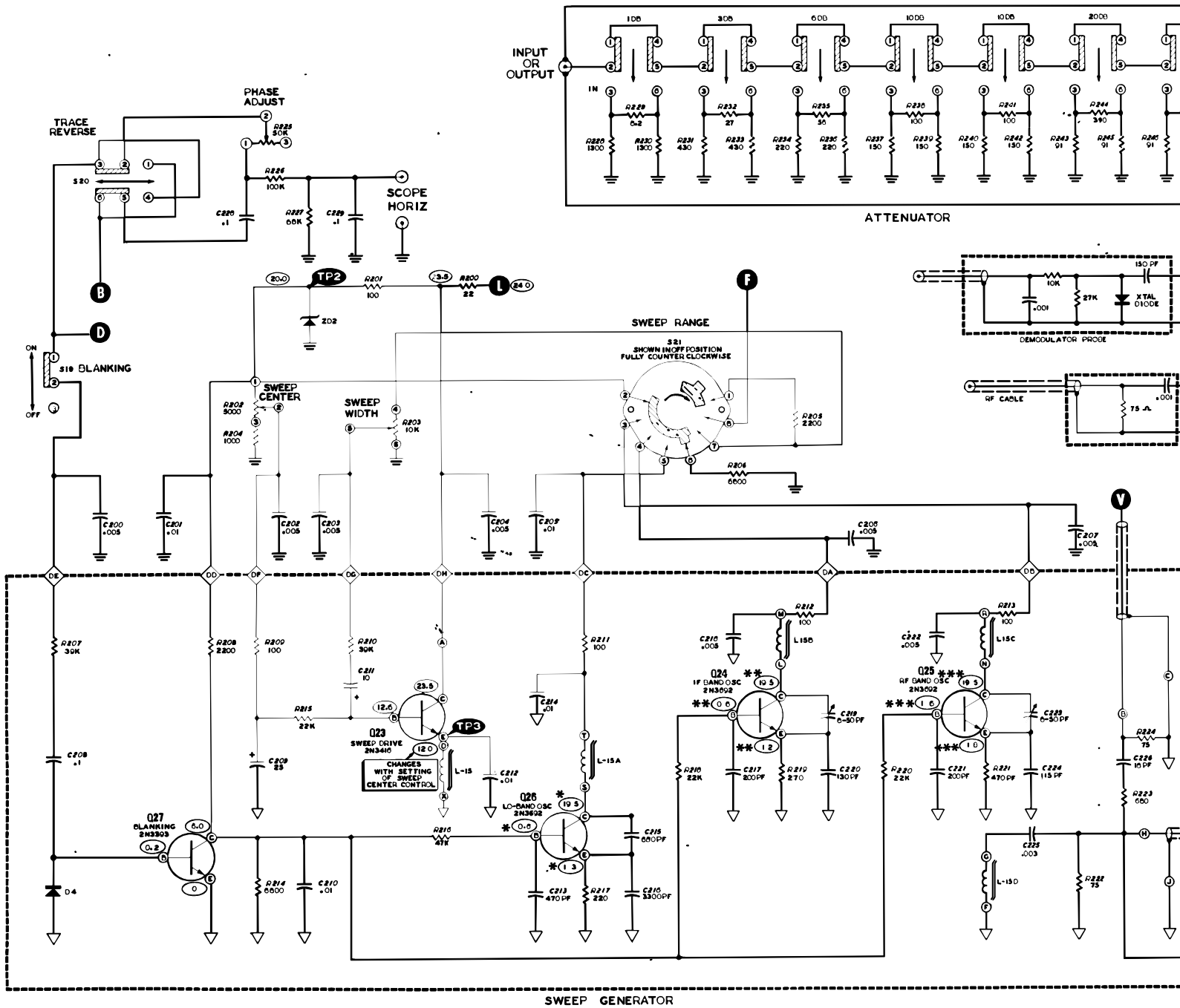

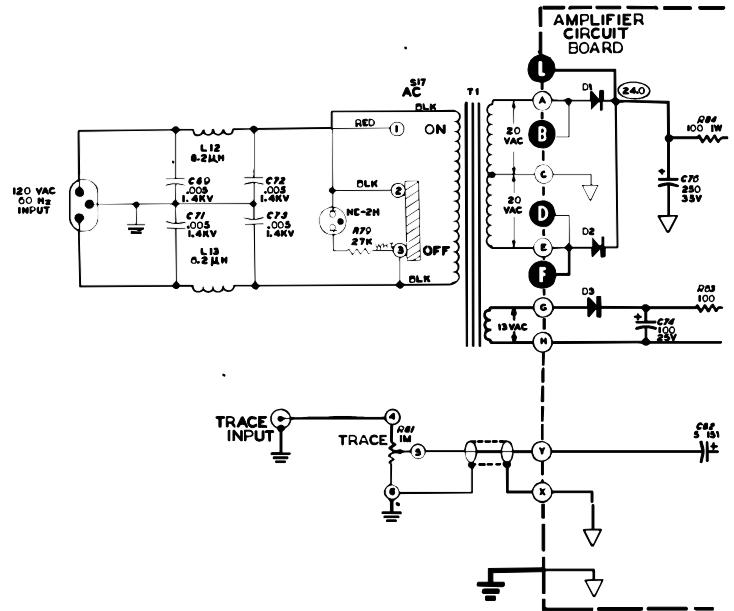
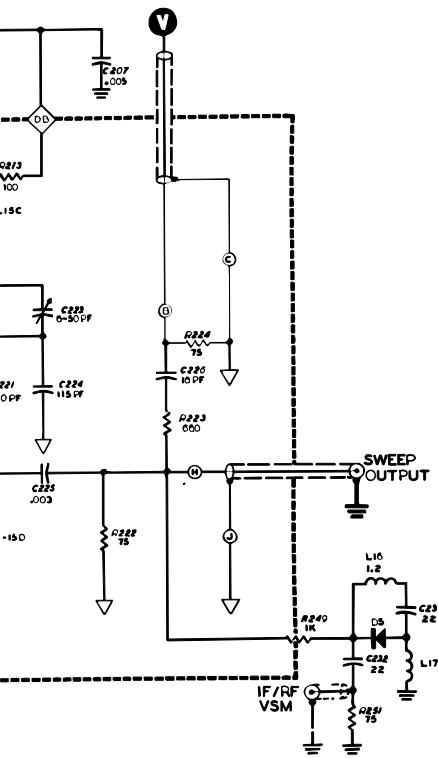
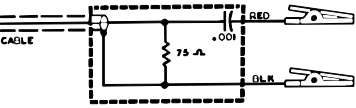
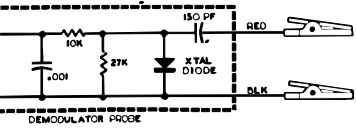
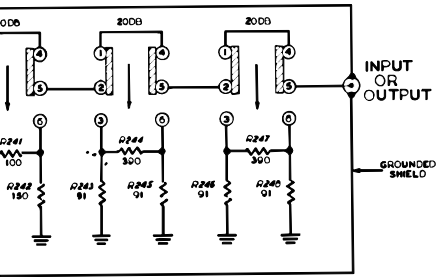
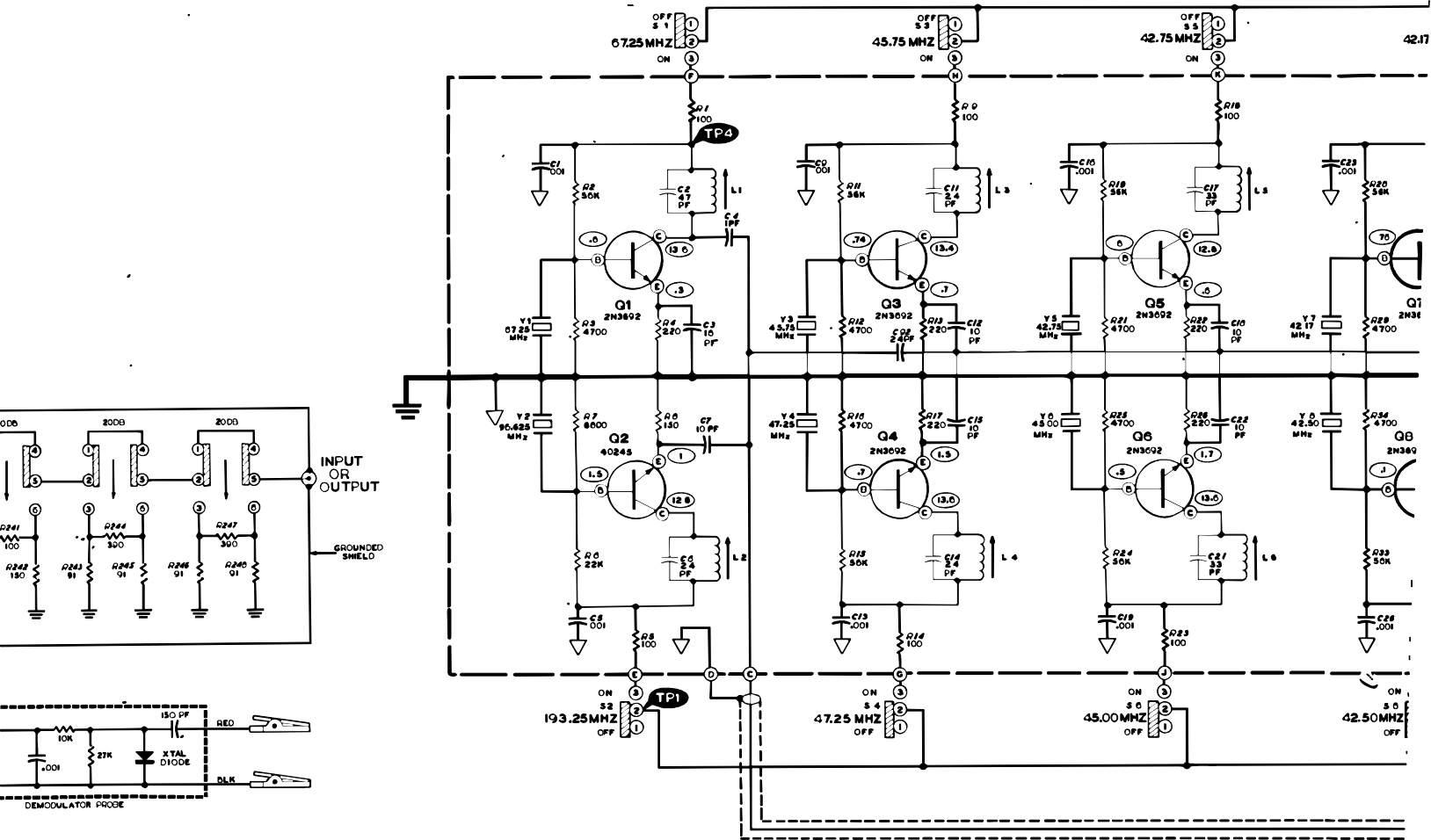

**SCHEMATIC OF THE
HEATHKIT®
TV POST-MARKER/SWEEP GENERATOR
MODEL IG-57A**

16 MARKER OSCILLATORS

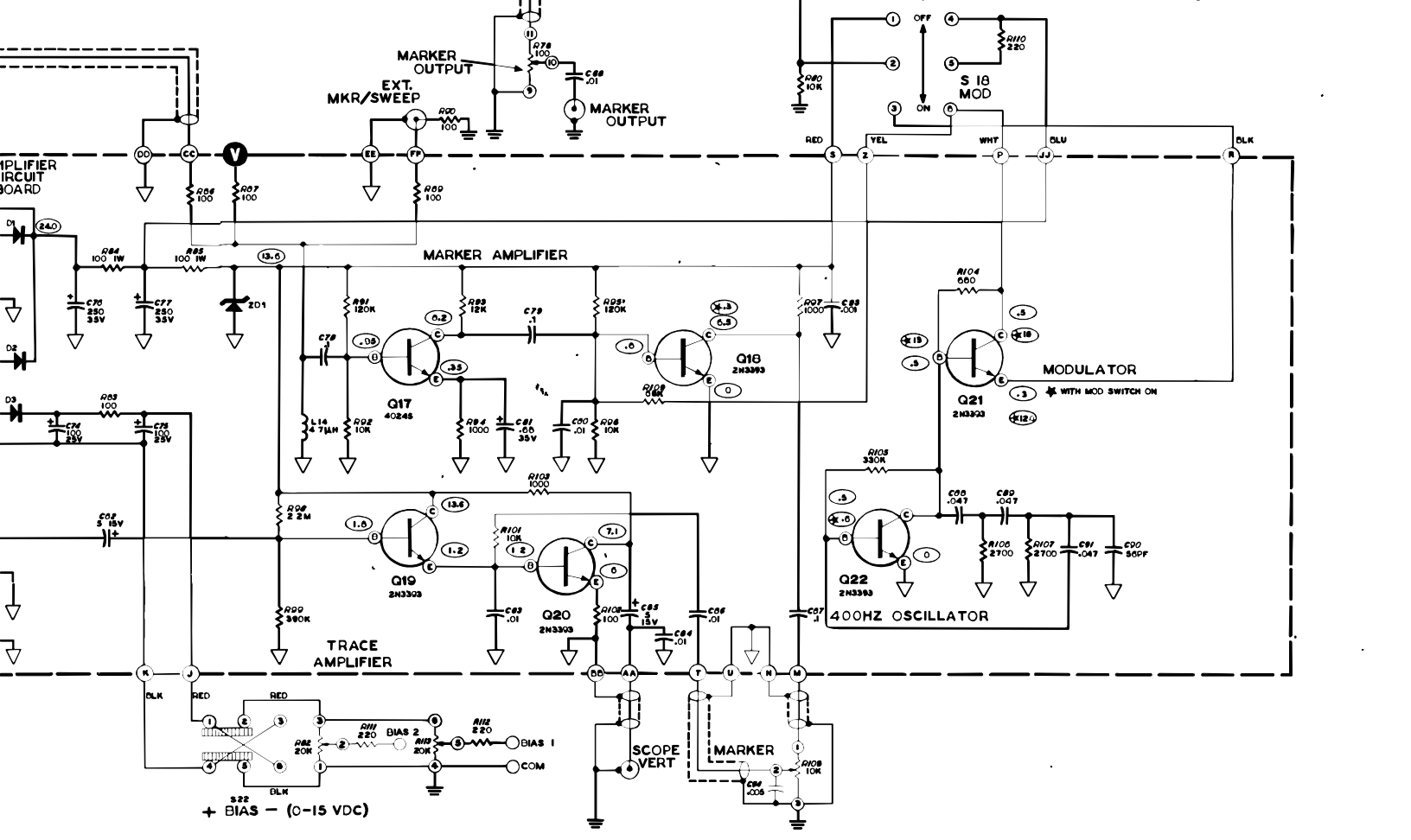
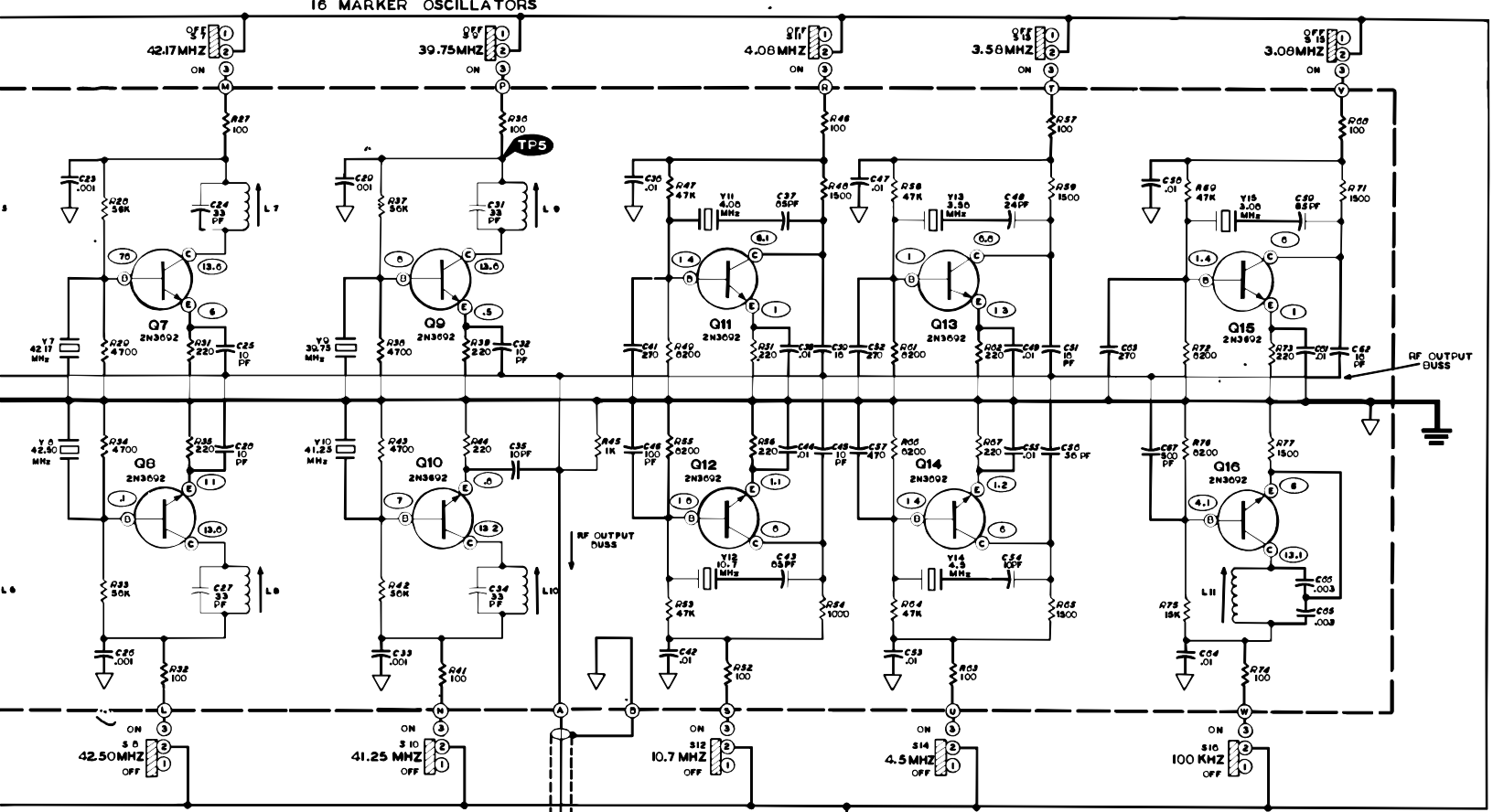

HEATH COMPANY

THE WORLD'S FINEST ELECTRONIC EQUIPMENT IN KIT FORM



created using
BCL easyPDF
Printer Driver